

MBOX

SHOWER ENCLOSURES







MERLYN Lifetime Guarantee

MERLYN shower enclosures are meticulously crafted and engineered to deliver a lifetime of unmatched performance and style. We stand behind every product with a lifetime guarantee, reflecting our absolute confidence in the superior quality of our design, engineering, and craftsmanship. This guarantee is more than a promise—it's part of the complete experience we offer, ensuring that from the moment you choose MERLYN, you enjoy unparalleled service, satisfaction, and peace of mind for years to come.

For more about our MERLYN Lifetime Guarantee, contact our MERLYN customer service team on 0808 1011 429

Register your MERLYN product:

To register your new MERLYN product for the Lifetime Guarantee, log on to www.merlynshowering.com and fill in your information.



**LIFETIME
GUARANTEE**



MERLYN™

Wetroom Collection

**Create daily moments of pure indulgence
in six impeccable finishes:**

Matt Black, Brushed Brass, Brushed Bronze, Chrome,
Brushed Nickel, and Brushed Gun Metal.

Enhance your sensory journey with our fluted glass. Protected by our
lifetime guarantee - everyday luxury that speaks to all the senses.



Anodised finish - The colour layer is fully integrated with the underlying aluminium substrate, so it cannot chip or peel. Making it more durable than powder coating.



Contents

Collections

MBOX

Sliding Door	2
Sliding door Loft Heights	3
Sliding door Low Access	4
1 Door Quadrant	5
2 Door Quadrant	6
2 Door Quadrant Loft Height	7
Bifold Door	8
Bifold Door Loft Height	9
Pivot Door.....	10
Corner Door	11
Inline Panels	12

The MERLYN Wetroom Collection

8mm Wetrooms	14
--------------------	----

Bath Screens	16
--------------------	----

MERLYN Trays

Touchstone Trays	20
Slip Resistant Trays	22

Technical Information

Product Information	24
---------------------------	----



Anodised finish - The colour layer is fully integrated with the underlying aluminium substrate, so it cannot chip or peel. Making it more durable than powder coating.



MBOX

SHOWER ENCLOSURES

Extensive Range - 53 sizes available

The MBOX range delivers stylish, quality products with additional features and benefits including heights of 1800mm and 1900mm and comes with pre-assembled fixtures making it easier to fit.

MBOX offers loft height sizes (1800mm) in Sliding Doors, Bifold Doors, Two Door Quadrants and Side Panels. These loft sizes are ideal for low ceilings, making the most out of the space in your bathroom.

6^{MM}
GLASS
THICKNESS

1900
MM
HEIGHT
STANDARD RANGE

Unique Easy Fit System

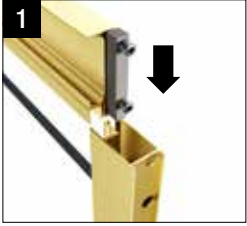

Align the horizontal and vertical profiles together.

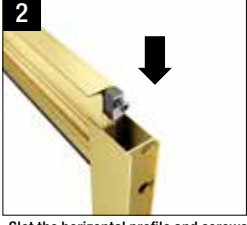

Slot the horizontal profile and screws into upright using guide channel until flush.

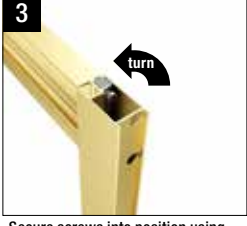

Secure screws into position using dedicated access holes.

Double Rollers



All rollers on MBOX products are double quick release for easy cleaning.

Inline Panels



MBOX offers Inline Panels that can be used in any space from 650mm to 1900mm.

Loft sizes



MBOX offers 3 reduced height doors. Perfect for converted loft spaces. Available in sliding door, bifold door, side panels and two door quadrant.

Sliding Door

Features

- » Height 1900mm
- » Reversible
- » Magnetic seals
- » Easy to install
- » Mershield™ protected glass
- » Chrome designer handle
- » UKCA & CE Approved
- » Can be fitted with two side panels
- » 20mm adjustment per wall profile
- » Optional cover strips available - see pg 13



Sliding door with Side Panel / Shown Right Hand / Brushed Brass

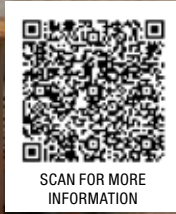

Sliding Door in Recess & for use with Side Panel			Chrome Pricing		Colour Pricing		
Size	Adjustment	Code	Colour Code	Price £ Exc. VAT	Price £ Inc. VAT	Price £ Exc. VAT	Price £ Inc. VAT
1000	950 - 990	MBS1000	add MB or BBR	419.17	503.00	558.33	670.00
1100	1050 - 1090	MBS1100	add MB or BBR	422.50	507.00	566.67	680.00
1200	1150 - 1190	MBS1200	add MB or BBR	424.17	509.00	575.00	690.00
1300	1250 - 1290	MBS1300	add MB or BBR	497.50	597.00	666.67	800.00
1400	1350 - 1390	MBS1400	add MB or BBR	500.00	600.00	700.00	840.00
1500	1450 - 1490	MBS1500	add MB or BBR	515.00	618.00	733.33	880.00
1600	1550 - 1590	MBS1600	Chrome only	530.00	636.00	N/A	N/A
1700	1650 - 1690	MBS1700	Chrome only	545.83	655.00	N/A	N/A

Please Note: Cover strips do not come as standard and need to be ordered separately if required - see page 13

Optional Side Panel			Chrome Pricing		Colour Pricing		
Size	Adjustment	Code	Colour Code	Price £ Exc. VAT	Price £ Inc. VAT	Price £ Exc. VAT	Price £ Inc. VAT
700	670 - 690	MBSP700	add MB or BBR	234.17	281.00	325.00	390.00
760	730 - 750	MBSP760	add MB or BBR	235.00	282.00	333.33	400.00
800	770 - 790	MBSP800	add MB or BBR	238.33	286.00	341.67	410.00
900	870 - 890	MBSP900	add MB or BBR	249.17	299.00	350.00	420.00
1000	970 - 990	MBSP1000	add MB or BBR	310.83	373.00	433.33	520.00

Optional Inline Panel - Chrome only

Size	Adjustment	Code	Price £ Exc. VAT	Price £ Inc. VAT
150	130 - 150	MBN150	210.00	252.00
210	190 - 210	MBN210	213.33	256.00

For more information on Inline Panels see page 13

Add Colour; Express yourself

When ordering your door please use the correct code to the size required. Then add the colour code you need. Example: MBS1000 is the standard chrome code add **MB** for Matt Black or **BBR** for Brushed Brass. **Example:** MBS1000 + MB (Matt Black) = MBS1000MB. Chrome option is your standard code.



Technical drawing

Size	X	B
1000	367	430
1100	417	480
1200	467	530
1300	517	580
1400	567	630
1500	567	730
1600	567	830
1700	567	930

X: Door Opening
B = Fixed Panel
D = Side Panel

Sliding Door in Recess



Sliding Door with Side Panel

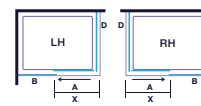

Sliding Door with two Side Panel

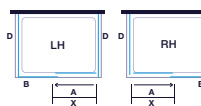

Max side panel size is 1000mm when using two side panels.



Sliding Door Loft Height - Chrome Only

Features

- » Height 1800mm
- » Reversible
- » Magnetic seals
- » Easy to install
- » Mershield™ protected glass
- » Chrome designer handle
- » UKCA & CE Approved
- » 20mm adjustment per wall profile
- » Optional cover strips available - see pg 13



Sliding door - Loft Height in Recess / Shown Right Hand / Chrome Only

Sliding Door in Recess & for use with Side Panel			Chrome Pricing	
Size	Adjustment	Code	Price £ Exc. VAT	Price £ Inc. VAT
1200	1150 - 1190	MBS1200/1800	519.17	623.00

Please Note: Cover strips do not come as standard and need to be ordered separately if required - see page 13

Optional Side Panel			Chrome Pricing	
Size	Adjustment	Code	Price £ Exc. VAT	Price £ Inc. VAT
800	770 - 790	MBSP800/1800	286.67	344.00
900	870 - 890	MBSP900/1800	310.83	373.00

Technical drawing

Size	X	B
1200	467	530

X: Door Opening
B = Fixed Panel
D = Side Panel

Sliding Door in Recess



Sliding Door with Side Panel

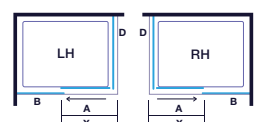



Low Level Access Sliding Door Chrome Only

Features

- » No bottom rollers
 - » Bottom glide system
 - » Easy-fit system
 - » Mershield™ protected glass
 - » Handed
 - » UKCA & CE Approved
 - » Push button door release for easy clean
 - » Adjustable fin seal for increased water retention
 - » Optional cover strips available - see pg 13
 - » Threshold strip just 6mm high
- Note: Products are left or right handed due to bottom guide and no bottom profile.



SCAN FOR MORE INFORMATION

Low Level Access Sliding door with Side Panel / Shown Right Hand

Low Level Access Sliding Door

Size	Adjustment	Code	Price £ Exc. VAT	Price £ Inc. VAT
1000	950 - 990	MBLA1000L	496.67	596.00
1000	950 - 990	MBLA1000R	496.67	596.00
1200	1150 - 1190	MBLA1200L	504.17	605.00
1200	1150 - 1190	MBLA1200R	504.17	605.00
1400	1350 - 1390	MBLA1400L	582.50	699.00
1400	1350 - 1390	MBLA1400R	582.50	699.00
1700	1650 - 1690	MBLA1700L	635.83	763.00
1700	1650 - 1690	MBLA1700R	635.83	763.00

Please Note: Cover strips do not come as standard and need to be ordered separately if required - see page 13

Optional Side Panel

Size	Adjustment	Code	Price £ Exc. VAT	Price £ Inc. VAT
700	670 - 690	MBSP700	234.17	281.00
760	730 - 750	MBSP760	235.00	282.00
800	770 - 790	MBSP800	238.33	286.00
900	870 - 890	MBSP900	249.17	299.00
1000	970 - 990	MBSP1000	310.83	373.00



Low Level Access Sliding door in recess



Push Release



Bottom Glide System

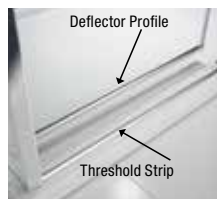

Slimline Threshold

Technical drawing

Size	X	B
1000	365	435
1200	465	535
1400	565	635
1700	565	935

Sliding Door with Side Panel

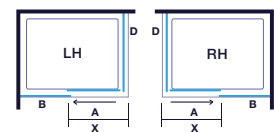

X: Door Opening
B = Fixed Panel
D = Side Panel



1 Door Quadrant / Shown Right Hand / Brushed Brass

1 Door Quadrant

Features

- » Height 1900mm
- » Reversible
- » Easy to install
- » Quick release double rollers for easy clean
- » Mershield™ protected glass
- » Chrome designer handle
- » UKCA & CE Approved
- » 20mm adjustment per wall profile
- » Optional cover strips available - see pg 13



SCAN FOR MORE INFORMATION

1 Door Quadrant			Chrome Pricing		Colour Pricing		
Size	Adjustment	Code	Colour Code	Price £ Exc. VAT	Price £ Inc. VAT	Price £ Exc. VAT	Price £ Inc. VAT
800 x 800	770 - 790	MB1Q800	add MB or BBR	558.33	670.00	700.00	840.00
900 x 900	870 - 890	MB1Q900	add MB or BBR	564.17	677.00	708.33	850.00
1000 x 1000	970 - 990	MB1Q1000	Chrome only	675.00	810.00	N/A	N/A

1 Door Offset Quadrant			Chrome Pricing		Colour Pricing		
Size	Adjustment	Code	Colour Code	Price £ Exc. VAT	Price £ Inc. VAT	Price £ Exc. VAT	Price £ Inc. VAT
900 x 760	870 - 890 / 730 - 750	MB1Q976	Chrome only	643.33	772.00	N/A	N/A
1000 x 800	970 - 990 / 770 - 790	MB1Q1080	add MB or BBR	660.83	793.00	833.33	1000.00
1200 x 800	1170 - 1190 / 770 - 790	MB1Q1280	add MB or BBR	676.67	812.00	916.67	1100.00
1200 x 900	1170 - 1190 / 870 - 890	MB1Q1290	add MB or BBR	703.33	844.00	958.33	1150.00

Please Note: Cover strips do not come as standard and need to be ordered separately if required - see page 13



1 Door Offset Quadrant / Shown Right Hand / Matt Black

Add Colour;
Express yourself

When ordering your door please use the correct code to the size required. Then add the colour code you need. Example: MB1Q800 is the standard chrome code add **MB** for Matt Black or **BBR** for Brushed Brass. **Example:** MB1Q800 + MB (Matt Black) = MB1Q800MB. Chrome option is your standard code.

 BBR = Brushed Brass
  Standard Chrome
  MB = Matt Black

Technical drawing

Size	X	B	C
800 x 800	422	490	235
900 x 760	409	470	550
900 x 900	476	529	335
1000 x 800	422	490	435
1000 x 1000	476	629	435
1200 x 800	424	490	635
1200 x 900	475	529	635

1 Door Offset Quadrant



1 Door Quadrant



B: Straight Panel
 C: Curved Panel
 X: Door Opening



2 Door Quadrant

Features

- » Height 1900mm
- » Reversible
- » Magnetic seals
- » Easy to install
- » Quick release double rollers for easy clean
- » Mershield™ protected glass
- » Chrome designer handle
- » UKCA & CE Approved
- » 20mm adjustment per wall profile
- » Loft height available
- » Optional cover strips available - see pg 13

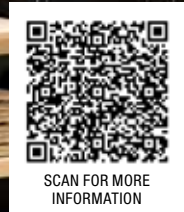

SCAN FOR MORE INFORMATION

2 Door Quadrant / Matt Black

2 Door Quadrant			Chrome Pricing		Colour Pricing		
Size	Adjustment	Code	Colour Code	Price £ Exc. VAT	Price £ Inc. VAT	Price £ Exc. VAT	Price £ Inc. VAT
800 x 800	770 - 790	MB2Q800	add MB or BBR	407.50	489.00	583.33	700.00
900 x 900	870 - 890	MB2Q900	add MB or BBR	411.67	494.00	591.67	710.00

2 Door Offset Quadrant							
Size	Adjustment	Code	Colour Code	Price £ Exc. VAT	Price £ Inc. VAT	Price £ Exc. VAT	Price £ Inc. VAT
900 x 760	870 - 890 / 730 - 750	MB2Q9076	Chrome only	475.00	570.00	N/A	N/A
900 x 800	870 - 890 / 770 - 790	MB2Q8090	Chrome only	499.17	599.00	N/A	N/A
1000 x 800	970 - 990 / 770 - 790	MB2Q1080	Chrome only	503.33	604.00	N/A	N/A
1200 x 800	1170 - 1190 / 770 - 790	MB2Q1280	Chrome only	524.17	629.00	N/A	N/A
1200 x 900	1170 - 1190 / 870 - 890	MB2Q1290	Chrome only	548.33	658.00	N/A	N/A

Please Note: Cover strips do not come as standard and need to be ordered separately if required - see page 13



SCAN FOR MORE INFORMATION

2 Door Offset Quadrant

Add Colour; Express yourself

When ordering your door please use the correct code to the size required. Then add the colour code you need. Example: MB2Q800 is the standard chrome code add **MB** for Matt Black or **BBR** for Brushed Brass. **Example:** MB2Q800 + MB (Matt Black) = MB2Q800MB.

Chrome option is your standard code.



Technical drawing

Size	X	B	C
800 x 800	401	235	N/A
900 x 760	432	335	195
900 x 900	524	335	N/A
900 x 800	437	335	235
1000 x 800	465	435	235
1200 x 800	465	635	235
1200 x 900	524	635	335

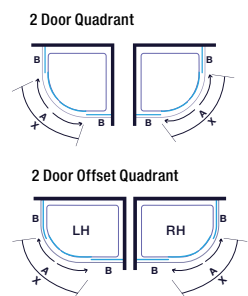

B: Straight Panel
C: Curved Panel
X: Door Opening



2 Door Quadrant Loft Height - Chrome Only

Features

- » Height 1800mm
- » Reversible
- » Magnetic seals
- » Easy to install
- » Quick release double rollers for easy clean
- » Mershield™ protected glass
- » Chrome designer handle
- » UKCA & CE Approved
- » 20mm adjustment per wall profile
- » Optional cover strips available - see pg 13



SCAN FOR MORE
INFORMATION

2 Door Quadrant - Loft Height / Chrome Only

2 Door Quadrant			Chrome Pricing	
Size	Adjustment	Code	Price £ Exc. VAT	Price £ Inc. VAT
800 x 800	770 - 790	MB2Q800/1800	498.33	598.00
900 x 900	870 - 890	MB2Q900/1800	503.33	604.00

Please Note: Cover strips do not come as standard and need to be ordered separately if required - see page 13

Technical drawing

Size	X	B
800 x 800	401	235
900 x 900	524	335

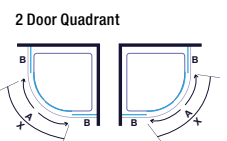

B: Straight Panel
X: Door Opening



Bifold Door

Features

- » Height 1900mm
- » 4mm toughened safety glass
- » Reversible
- » Magnetic close
- » Mershield™ protected glass
- » Chrome designer handle
- » Loft height available
- » UKCA & CE Approved
- » 20mm adjustment per wall profile
- » Optional cover strips available - see pg 13



SCAN FOR MORE INFORMATION

Bifold Door / Shown Right Hand / Brushed Brass

Bifold Door			Chrome Pricing		Colour Pricing		
Size	Adjustment	Code	Colour Code	Price £ Exc. VAT	Price £ Inc. VAT	Price £ Exc. VAT	Price £ Inc. VAT
700	650 - 690	MBB700	add MB or BBR	399.17	479.00	533.33	640.00
760	710 - 750	MBB760	add MB or BBR	400.83	481.00	533.33	640.00
800	750 - 790	MBB800	add MB or BBR	403.33	484.00	541.67	650.00
900	850 - 890	MBB900	add MB or BBR	420.00	504.00	550.00	660.00
1000	950 - 990	MBB1000	add MB or BBR	452.50	543.00	633.33	760.00

Please Note: Cover strips do not come as standard and need to be ordered separately if required - see page 13

Optional Side Panel			Chrome Pricing		Colour Pricing		
Size	Adjustment	Code	Colour Code	Price £ Exc. VAT	Price £ Inc. VAT	Price £ Exc. VAT	Price £ Inc. VAT
700	670 - 690	MBSP700	add MB or BBR	234.17	281.00	325.00	390.00
760	730 - 750	MBSP760	add MB or BBR	235.00	282.00	333.33	400.00
800	770 - 790	MBSP800	add MB or BBR	238.33	286.00	341.67	410.00
900	870 - 890	MBSP900	add MB or BBR	249.17	299.00	350.00	420.00
1000	970 - 990	MBSP1000	add MB or BBR	310.83	373.00	433.33	520.00

Optional Inline Panel - Chrome only

Size	Adjustment	Code	Price £ Exc. VAT	Price £ Inc. VAT
150	130 - 150	MBN150	210.00	252.00
210	190 - 210	MBN210	213.33	256.00

For more information on Inline Panels see page 13

Add Colour; Express yourself

When ordering your door please use the correct code to the size required. Then add the colour code you need. Example: MBB700 is the standard chrome code add **MB** for Matt Black or **BBR** for Brushed Brass. **Example:** MBB700 + MB (Matt Black) = MBB700MB. Chrome option is your standard code.



BBR = Brushed Brass Standard Chrome MB = Matt Black

Technical drawing

Bifold Door in Recess

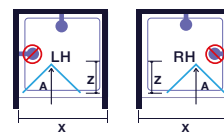

Bifold Door with Side Panel

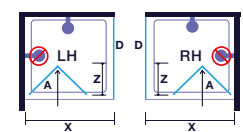

Size	X	Z
700	370	296
760	430	325
800	470	347
900	570	398
1000	670	454

A: Moving Panel
D: Side Panel
X: Door Opening
Z: Width of panel when folded



Bifold Door Loft Height - Chrome Only

Features

- » Height 1800mm
- » 4mm toughened safety glass
- » Reversible
- » Magnetic close
- » Mershield™ protected glass
- » Chrome designer handle
- » UKCA & CE Approved
- » 20mm adjustment per wall profile
- » Optional cover strips available - see pg 13

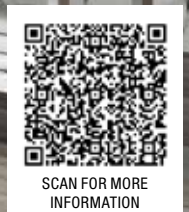

Bifold Door - Loft Heights / Shown Right Hand / Chrome

Bifold Door			Chrome Pricing	
Size	Adjustment	Code	Price £ Exc. VAT	Price £ Inc. VAT
760	710 - 750	MBB760/1800	505.83	607.00
800	750 - 790	MBB800/1800	510.83	613.00
900	850 - 890	MBB900/1800	537.50	645.00

Measurements above are for both Bifold Door with a Side panel and in a Recess. Please Note: Cover strips do not come as standard and need to be ordered separately if required - see page 13

Optional Side Panel			Chrome Pricing	
Size	Adjustment	Code	Price £ Exc. VAT	Price £ Inc. VAT
800	770 - 790	MBSP800/1800	286.67	344.00
900	870 - 890	MBSP900/1800	310.83	373.00

Technical drawing

Bifold Door in Recess

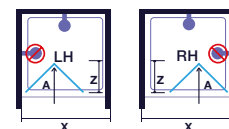

Bifold Door with Side Panel

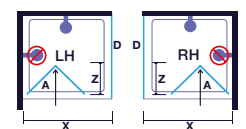

Size	X	Z
760	430	325
800	470	347
900	570	398

A: Moving Panel
D: Side Panel
X: Door Opening
Z: Width of panel when folded

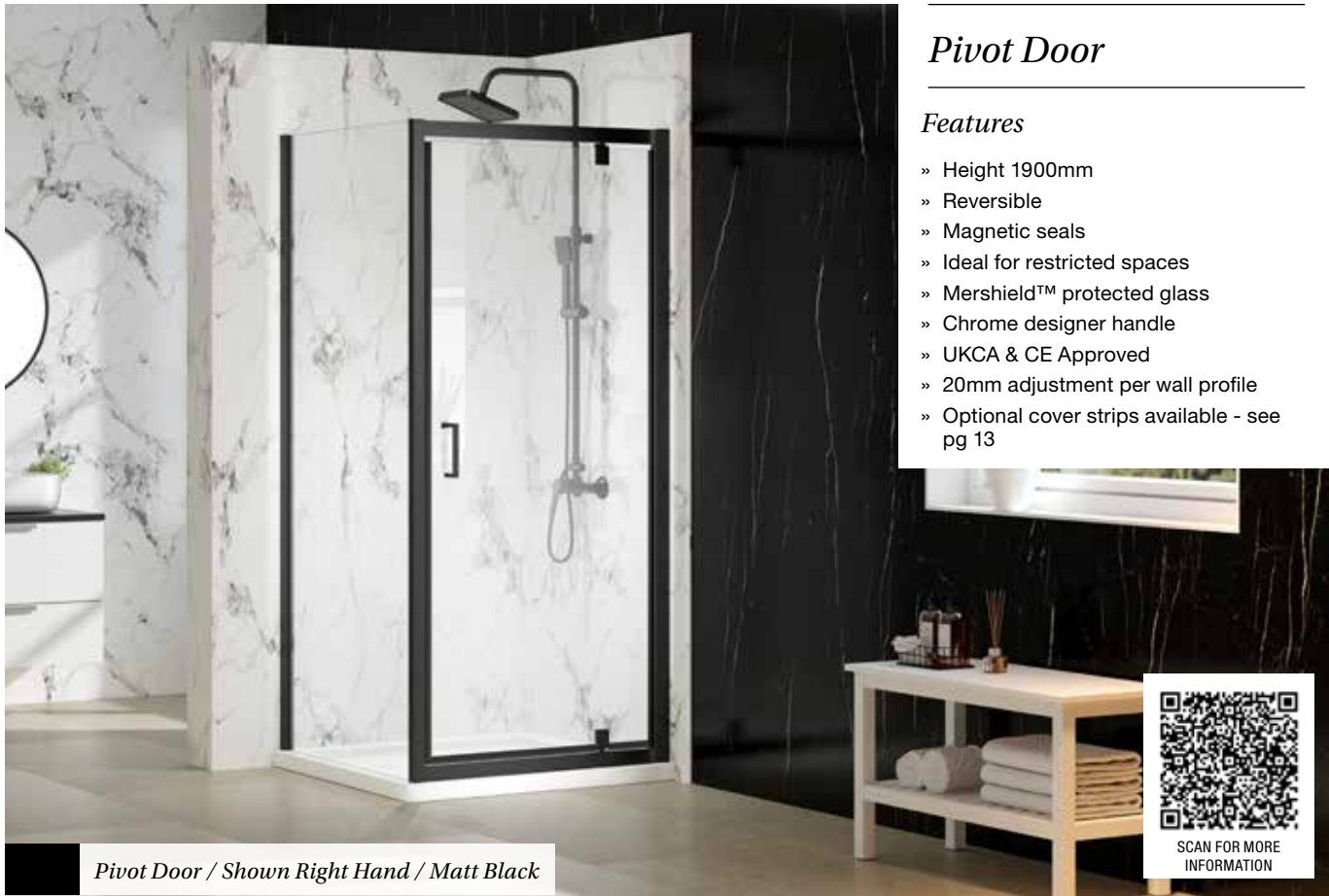

Pivot Door

Features

- » Height 1900mm
- » Reversible
- » Magnetic seals
- » Ideal for restricted spaces
- » Mershield™ protected glass
- » Chrome designer handle
- » UKCA & CE Approved
- » 20mm adjustment per wall profile
- » Optional cover strips available - see pg 13

Pivot Door / Shown Right Hand / Matt Black

Pivot Door			Chrome Pricing		Colour Pricing		
Size	Adjustment	Code	Colour Code	Price £ Exc. VAT	Price £ Inc. VAT	Price £ Exc. VAT	Price £ Inc. VAT
700	650 - 690	MBP700	Chrome only	347.50	417.00	N/A	N/A
760	710 - 750	MBP760	add MB or BBR	351.67	422.00	483.33	580.00
800	750 - 790	MBP800	add MB or BBR	353.33	424.00	491.67	590.00
900	850 - 890	MBP900	add MB or BBR	377.50	453.00	508.33	610.00
1000	950 - 990	MBP1000	Chrome only	405.00	486.00	N/A	N/A

Please Note: Cover strips do not come as standard and need to be ordered separately if required - see page 13

Optional Side Panel			Chrome Pricing		Colour Pricing		
Size	Adjustment	Code	Colour Code	Price £ Exc. VAT	Price £ Inc. VAT	Price £ Exc. VAT	Price £ Inc. VAT
700	670 - 690	MBSP700	add MB or BBR	234.17	281.00	325.00	390.00
760	730 - 750	MBSP760	add MB or BBR	235.00	282.00	333.33	400.00
800	770 - 790	MBSP800	add MB or BBR	238.33	286.00	341.67	410.00
900	870 - 890	MBSP900	add MB or BBR	249.17	299.00	350.00	420.00
1000	970 - 990	MBSP1000	add MB or BBR	310.83	373.00	433.33	520.00

Optional Inline Panel - Chrome only

Size	Adjustment	Code	Price £ Exc. VAT	Price £ Inc. VAT
150	130 - 150	MBN150	208.33	250.00
210	190 - 210	MBN210	204.17	245.00

For more information on Inline Panels see page 13

Add Colour; Express yourself

When ordering your door please use the correct code to the size required. Then add the colour code you need. Example: MBP700 is the standard chrome code add **MB** for Matt Black or **BBR** for Brushed Brass. **Example:** MBP700 + MB (Matt Black) = MBP700MB.

Chrome option is your standard code.



BBR = Brushed Brass Standard Chrome MB = Matt Black

Technical drawing

Pivot Door in Recess

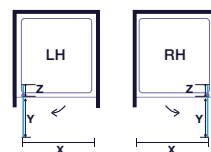

Pivot Door with Side Panel

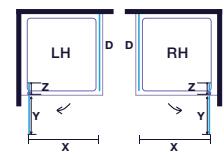

Size	X	Y
700	441	433
760	501	493
800	541	533
900	590	583
1000	661	653

D: Side Panel
Y: Outside Door Swing
X: Door Opening
Z: Inside Door Swing



Corner Door Chrome Only

Features

- » Height 1900mm
- » Reversible
- » Magnetic seals
- » Easy to install
- » Mershield™ protected glass
- » Chrome designer handle
- » UKCA & CE Approved
- » 20mm adjustment per wall profile
- » Optional cover strips available - see pg 13

Corner Door / Chrome Only

Corner Door				
Size	Adjustment	Code	Price £ Exc. VAT	Price £ Inc. VAT
760 x 760	730 - 750	MBC760	606.67	728.00
800 x 800	770 - 790	MBC800	620.83	745.00
900 x 900	870 - 890	MBC900	673.33	808.00
1000 x 1000	970-990	MBC1000	707.50	849.00

Please Note: Cover strips do not come as standard and need to be ordered separately if required - see page 13

Technical drawing

Corner Door

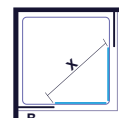

X: Door Opening
B: Fixed Panel

Size	X	B
760 x 760	345	310
800 x 800	375	330
900 x 900	444	380

Inline Panels - Chrome Only

MBOX also offers you additional Inline Panel options. A great solution for spaces which don't suit standard size enclosures. The two Inline Panel sizes each combined with our existing Sliding, Bifold and Pivot Doors, can make an enclosure to fit any space from 650mm to 1900mm wide.

Size	Code	Price £ Ex. VAT	Price £ Inc. VAT
150	MBN150	210.00	252.00
210	MBN210	213.33	256.00



Sliding door with inline panel



Pivot door with inline panel



Bifold door with inline panel

Sliding Door - with inline panel

Code	Door Size	Door Adjustment	Inline Panels / Profile	Final Adjustment
MBS1000	1000	950-990	-	950-990
			EXT Profile	970-1010
MBS1000	1000	950-990	3 EXT Profile	990-1050
MBS1100	1100	1050-1090	-	1050-1090
			EXT Profile	1070-1110
MBS1000	1000	950-990	150 Inline	1080-1140
			210 Inline	1140-1200
MBS1100	1100	1050-1090	150 Inline	1180-1240
			210 Inline	1240-1300
MBS1200	1200	1150-1190	150 Inline	1280-1340
MBS1400	1400	1350-1390	-	1350-1390
			EXT Profile	1370-1410
MBS1100	1100	1050-1090	150+210 Inlines	1370-1450
MBS1500	1500	1450-1490	-	1450-1490
			EXT Profile	1470-1510
MBS1400	1400	1350-1390	150 Inline	1480-1540
			210 Inline	1540-1600
MBS1500	1500	1450-1490	150 Inline	1580-1640
			210 Inline	1640-1700
MBS1600	1600	1550-1590	150 Inline	1680-1740
			210 Inline	1740-1800
MBS1700	1700	1650-1690	150 Inline	1780-1840
			210 Inline	1840-1900

Pivot Door - with inline panel

Code	Door Size	Door Adjustment	Inline Panels / Profile	Final Adjustment
MBP700	700	650-690	-	650-690
			EXT Profile	670-710
MBP760	760	710-750	-	710-750
MBP800	800	750-790	-	750-790
			EXT Profile	770-810
MBP700	700	650-690	150 Inline	780-840
			210 Inline	840-900
MBP760	760	710-750	210 Inline	900-960
MBP1000	1000	950-990	EXT profile	970-1010
MBP900	900	850-890	150 Inline	980-1040
			210 Inline	1040-1100
MBP1000	1000	950-990	150 Inline	1080-1140
			210 Inline	1140-1200

Bifold Door - with inline panel

Code	Door Size	Door Adjustment	Inline Panels / Profile	Final Adjustment
MBB700	700	650-690	-	650-690
			EXT Profile	670-710
MBB760	760	710-750	-	710-750
MBB800	800	750-790	-	750-790
			EXT Profile	770-810
MBB700	700	650-690	150 Inline	780-840
			210 Inline	840-900
MBB760	760	710-750	210 Inline	900-960
MBB1000	1000	950-990	EXT profile	970-1010
MBB900	900	850-890	150 Inline	980-1040
			210 Inline	1040-1100
MBB1000	1000	950-990	150 Inline	1100-1140
			210 Inline	1140-1200

MBOX Extension Profiles

Code	Colour Code	Price £ Ex. VAT	Price £ Inc. VAT
A0214B0	add MB or BBR	67.50	81.00

Code	Price £ Ex. VAT	Price £ Inc. VAT
MBEXT1800	65.00	78.00

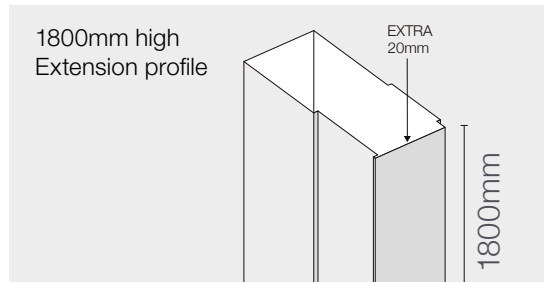
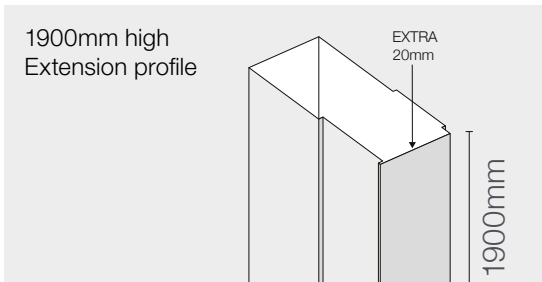

MBOX Cover Strips

Standard Panel Cover Strip Pack (2 Pieces)

Size		Chrome Pricing		Colour Pricing		
Size	Code	Colour Code	Price £ Ex. VAT	Price £ Inc. VAT	Price £ Ex. VAT	Price £ Inc. VAT
1900	MBWPKIT	add MB or BBR	73.33	88.00	79.17	95.00

Side Panel Cover Strip Pack (1 Piece)

Size		Chrome Pricing		Colour Pricing		
Size	Code	Colour Code	Price £ Ex. VAT	Price £ Inc. VAT	Price £ Ex. VAT	Price £ Inc. VAT
1900	MBSPKIT	add MB or BBR	59.17	71.00	62.50	75.00

Inline Panel Cover Strip Pack (1 Piece)

Size		Chrome Pricing	
Size	Code	Price £ Ex. VAT	Price £ Inc. VAT
1900	MBNKIT	60.83	73.00

Please note: Cover strips do not come as standard and need to be ordered separately if required.

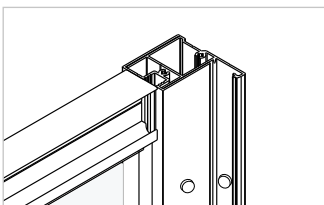

Without cover strip - chrome screw cover caps

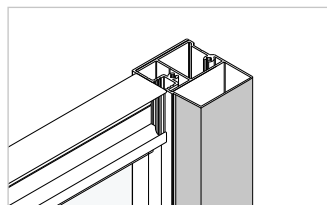

With cover strip - conceals all fixings

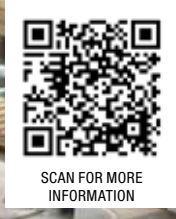

Wetroom Panel with Fluted Glass and Swivel Panel / Shown in Brushed Nickel Steel

8mm Wetroom Panels

Choose from a variety of shapes and sizes with our 8mm Wetroom Panels. Our modular system allows seamless customization for any wetroom space.

features

- » Height 2015mm (including rail)
- » Reversible
- » All panels from 700mm & above come with a 1000mm stabilising bar
- » 3m support post can be retro-fitted to glass thicknesses of 8mm
- » Suitable for recess or corner situation
- » Swivel panel can be retrofitted to any 8mm shower wall
- » Corner profile option available
- » Strong & sturdy construction

Wetroom Panels Colour

Ref	Size	Adjustment	Code	Colour Code	Price £ Exc. VAT	Price £ Inc. VAT
A	300	275-290	8W30	add BGM / MB / BBR / BN or BBZ	344.17	413.00
B	400	375-390	8W40	add BGM / MB / BBR / BN or BBZ	352.50	423.00
C	500	475-490	8W50	add BGM / MB / BBR / BN or BBZ	361.67	434.00
D	600	575-590	8W60	add BGM / MB / BBR / BN or BBZ	375.00	450.00
E	700	675-690	8W70	add BGM / MB / BBR / BN or BBZ	395.83	475.00
F	760	735-750	8W76	add BGM / MB / BBR / BN or BBZ	399.17	479.00
G	800	775-790	8W80	add BGM / MB / BBR / BN or BBZ	401.67	482.00
H	900	875-890	8W90	add BGM / MB / BBR / BN or BBZ	405.83	487.00
I	1000	975-990	8W10	add BGM / MB / BBR / BN or BBZ	435.83	523.00
J	1100	1075-1090	8W11	add BGM / MB / BBR / BN or BBZ	461.67	554.00
K	1200	1175-1190	8W12	add BGM / MB / BBR / BN or BBZ	464.17	557.00
L	1400	1375-1390	8W14	add BGM / MB / BBR / BN or BBZ	519.17	623.00
M	1600	1575-1590	8W16	add BGM / MB / BBR / BN or BBZ	575.00	690.00

Please Note: Panels A-H are the only panels that can be used as an end panel. Panels A-D do not come with a stabilising bar / Panels E-M come with stabilising bar. All panels 700mm and above come with 1000mm straight bracing bar. Sizes 700mm -900mm come with T-shape bracket to join two bracing bars.

Wetroom Panels Chrome

Ref	Size	Adjustment	Code	Price £ Exc. VAT	Price £ Inc. VAT
A	300	275-290	8W30	245.83	295.00
B	400	375-390	8W40	254.17	305.00
C	500	475-490	8W50	263.33	316.00
D	600	575-590	8W60	276.67	332.00
E	700	675-690	8W70	297.50	357.00
F	760	735-750	8W76	300.83	361.00
G	800	775-790	8W80	303.33	364.00
H	900	875-890	8W90	307.50	369.00
I	1000	975-990	8W10	337.50	405.00
J	1100	1075-1090	8W11	363.33	436.00
K	1200	1175-1190	8W12	365.83	439.00
L	1400	1375-1390	8W14	420.83	505.00
M	1600	1575-1590	8W16	476.67	572.00

Please Note: Panels A-H are the only panels that can be used as an end panel. Panels A-D do not come with a stabilising bar / Panels E-M come with stabilising bar. All panels 700mm and above come with 1000mm straight bracing bar. Sizes 700mm-900mm come with T-shape bracket to join two bracing bars.

Add Colour; Express yourself

When ordering your wetroom panel, please add the desired colour code to the end of the standard chrome code.

Example: 8W12 is the standard chrome code add **MB** for Matt Black, **BBR** for Brushed Brass, **BGM** for Brushed Gun Metal, **BN** for Brushed Nickel Steel or **BBZ** for Brushed Bronze.
E.G. 8W12MB = 8W12 Matt Black.



How it works: To make up a Walk In wetroom to fit on a 1200mm x 800mm tray or area floor space. You pick panel A (700mm) and panel B (800mm), this also includes the recommended 500mm minimum opening for the Walk In.

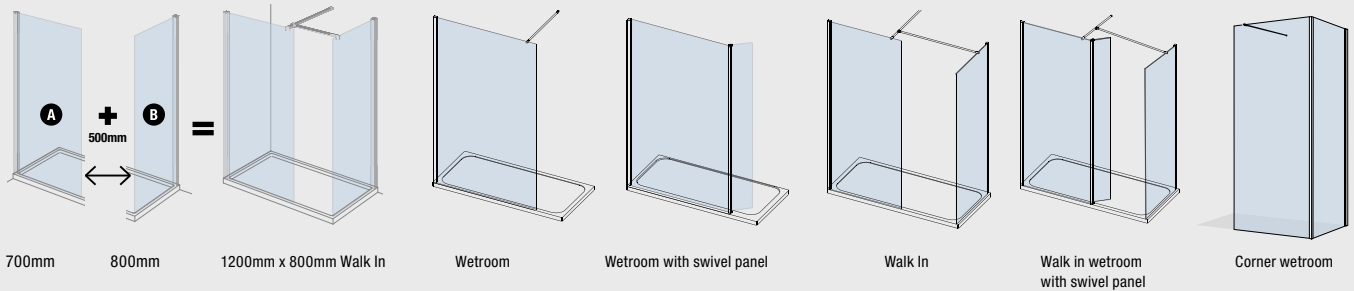

Fluted Wetroom Panels - in Colour & Chrome

Ref	Size	Product	Code	Colour Code	Price £ Exc. VAT	Price £ Inc. VAT
E	700	675-690	8WFL70	add BGM / MB / BBR / BN or BBZ	673.33	808.00
G	800	775-790	8WFL80	add BGM / MB / BBR / BN or BBZ	682.50	819.00
H	900	875-890	8WFL90	add BGM / MB / BBR / BN or BBZ	690.00	828.00
I	1000	975-990	8WFL10	add BGM / MB / BBR / BN or BBZ	740.83	889.00
J	1100	1075-1090	8WFL11	add BGM / MB / BBR / BN or BBZ	784.17	941.00
K	1200	1175-1190	8WFL12	add BGM / MB / BBR / BN or BBZ	789.17	947.00
X	300	Swivel Panel	8WFLSV30	add BGM / MB / BBR / BN or BBZ	392.50	471.00

Please Note: Panels E-H are the only panels that can be used as an end panel. All panels 700mm and above come with 1000mm straight bracing bar. Sizes 700mm -900mm come with T-shape bracket to join two bracing bars.

Technical drawing



Additional Options Chrome

Ref	Size	Product	Code	Price £ Exc. VAT	Price £ Inc. VAT
N	200	Swivel panel	8WSV20	166.67	200.00
O	300	Swivel panel	8WSV30	175.00	210.00
P	400	Swivel panel	8WSV40	187.50	225.00
Q	3000	Vertical ceiling post	3MCP	136.67	164.00
R	2000	Corner post profile	8WCR	64.17	77.00
S	1000	Round bracing bar	N126CH	136.67	164.00
T	1500	Round bracing bar	N127CH	166.67	200.00
U	-	Round T- piece bracket	A04S0010	46.67	56.00
V	350	Angled stabilising bar	SP08SCU12320	95.83	115.00
W	400	Vertical ceiling bracing bar	CBB440	117.50	141.00

Note: 3m vertical ceiling post can be retro-fitted to glass thickness of 8mm. Corner profile post is suitable for L-shape corner situations only & recommend using a stabilising bar for all size panels with this configuration. Corner Profile must be used with two Wetroom Panels. Round bracing bar can be retrofitted to 8mm glass.

Additional Options Colour

Ref	Size	Product	Code	Colour Code	Price £ Exc. VAT	Price £ Inc. VAT
O	300	Swivel panel	8WSV30	add BGM / MB / BBR / BN or BBZ	243.33	292.00
Q	3000	Vertical ceiling post	3MCP	add BGM / MB / BBR / BN or BBZ	179.17	215.00
R	2000	Corner post profile	8WCR	add BGM / MB / BBR / BN or BBZ	106.67	128.00
S	1000	Round bracing bar	N126	add BGM / MB / BBR / BN or BBZ	179.17	215.00
T	1500	Round bracing bar	N127	add BGM / MB / BBR / BN or BBZ	209.17	251.00
U	-	Round T- piece bracket	A04S0010	add BGM / B / BBR / BN or BBZ	76.67	92.00
W	400	Vertical ceiling bracing bar	CBB440	add BGM / MB / BBR / BN or BBZ	136.67	164.00

Note: 3m vertical ceiling post can be retro-fitted to glass thickness of 8mm. Corner profile post is suitable for L-shape corner situations only & recommend using a stabilising bar for all size panels with this configuration. Corner Profile must be used with two Wetroom Panels.

Waste Caps

NEW!

Description	Code	Price £ Exc. VAT	Price £ Inc. VAT
White	DWASCAPWHT	20.83	25.00
Matt Black	DWASCAPMB	28.33	34.00
Brushed Gun Metal	DWASCAPBGM	28.33	34.00
Brushed Bronze	DWASCAPBBZ	28.33	34.00
Brushed Brass	DWASCAPBBR	28.33	34.00
Brushed Nickel	DWASCAPBN	28.33	34.00

DWAS caps are now available in Matt Black (MB) / Brushed Brass (BBR) / Brushed Bronze (BBZ) / Brushed Gun Metal (BGM) and Brushed Nickel (BN). Chrome comes as standard.

MERLYN *bath screens*

some unique features

HydraSEAL

Exclusive to MERLYN Bath Screens

HydraSeal Experience the enhanced quality of Merlyn bath screens, now featuring a superior 'Leak Free' design. The innovative upgrade integrates the bracket and pivot into a single piece, eliminating potential leak paths. This not only ensures a cleaner, sleeker appearance but also makes installation easier than ever. Enjoy the perfect blend of functionality and style with Merlyn's latest bath screens.



HydraSEAL A single piece of 'Leak Free' technology!

HydraSEAL is available with the following Bath Screens: **MB1 / MB2 / MB3A / MB3B / MB3C**

Discover the technology behind our Leakfree Bath Screen: a single-piece, detailed design ensuring a flawless, leak-free experience.

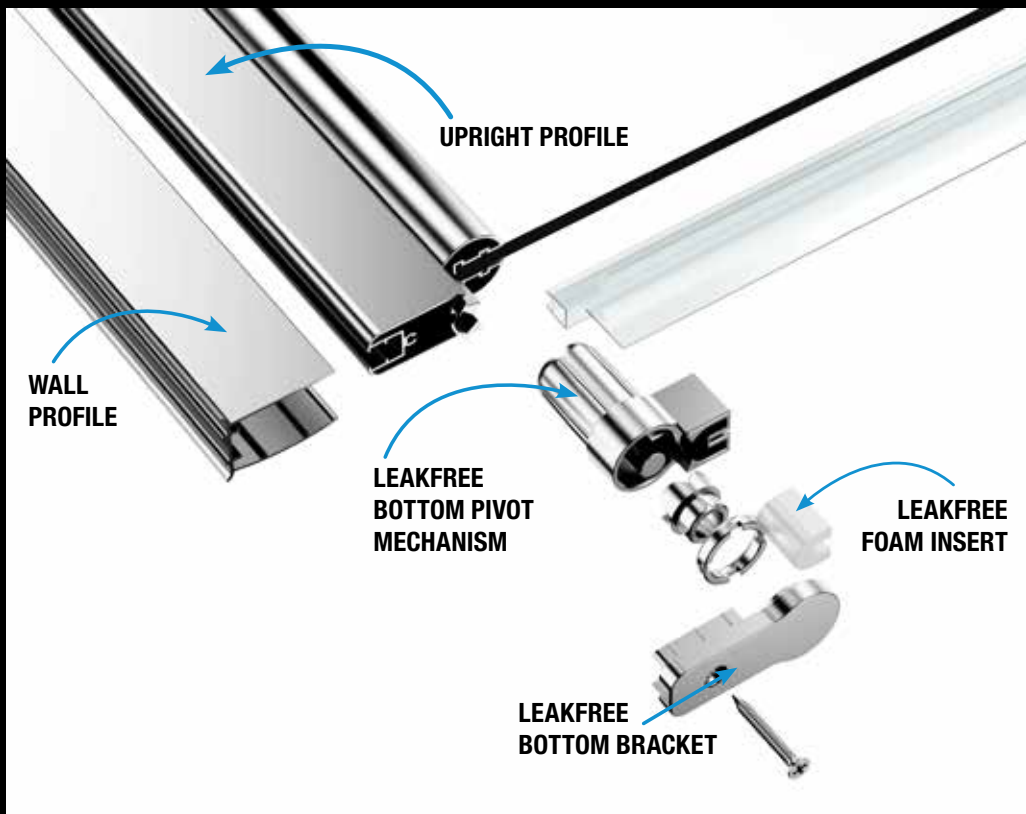

MB0
Bathscreen

SCAN FOR MORE INFORMATION

1500 MM
HEIGHT
THROUGH GLASS

6 MM
GLASS
THICKNESS

LIFETIME
GUARANTEE

Single Square Fixed Panel

Size	Code	Panel	Product Adjustment	Price £ Exc. VAT	Price £ Inc. VAT
800 x 1500	MB0	1	785-800	168.33	202.00

Features

- » Fixed frameless screen
- » 6mm toughened safety glass
- » Reversible
- » Lifetime guarantee

MB1
Bathscreen

SCAN FOR MORE INFORMATION

1500 MM
HEIGHT
THROUGH GLASS

6 MM
GLASS
THICKNESS

LIFETIME
GUARANTEE

HydraSEAL

Single Curved

Size	Code	Panel	Product Adjustment	Price £ Exc. VAT	Price £ Inc. VAT
800 x 1500	MB1	1	780-800	230.00	276.00

Features

- » Frameless curved screen
- » 6mm toughened safety glass
- » Reversible
- » Lifetime guarantee
- » Door swing - 90 degrees in and out

MB2
Bathscreen

SCAN FOR MORE INFORMATION

1500 MM
HEIGHT
THROUGH GLASS

6 MM
GLASS
THICKNESS

LIFETIME
GUARANTEE

MERSHIELD
STAYCLEAR

HydraSEAL

Single Square

Size	Code	Panel	Product Adjustment	Price £ Exc. VAT	Price £ Inc. VAT
800 x 1500	MB2	1	780-800	265.00	318.00

Features

- » Frameless screen
- » 6mm toughened safety glass
- » Mershield Stayclear™
- » Reversible
- » Lifetime guarantee
- » Door swing - 90 degrees in and out

MB2
Bathscreen

SCAN FOR MORE INFORMATION

1500 MM
HEIGHT
THROUGH GLASS

6 MM
GLASS
THICKNESS

LIFETIME
GUARANTEE

MERSHIELD
STAYCLEAR

HydraSEAL

Single Square With Towel Rail

Size	Code	Panel	Product Adjustment	Price £ Exc. VAT	Price £ Inc. VAT
800 x 1500	MB2T	1	780-800	347.50	417.00

Features

- » Frameless 6mm toughened safety glass
- » Mershield Stayclear™
- » Includes towel rail
- » HydraSeal sealant
- » Reversible
- » Lifetime guarantee
- » Door swing - 90 degrees in and out

MB3a
Bathscreen

SCAN FOR MORE INFORMATION

1500 MM
HEIGHT
6 MM
GLASS
THICKNESS
LIFETIME
GUARANTEE

HydraSEAL

MB3b
Bathscreen

SCAN FOR MORE INFORMATION

1500 MM
HEIGHT
6 MM
GLASS
THICKNESS
LIFETIME
GUARANTEE

HydraSEAL

MB3c
Bathscreen

SCAN FOR MORE INFORMATION

1500 MM
HEIGHT
6 MM
GLASS
THICKNESS
LIFETIME
GUARANTEE

HydraSEAL

MB4
Bathscreen

SCAN FOR MORE INFORMATION

1400 MM
HEIGHT
4 MM
GLASS
THICKNESS
LIFETIME
GUARANTEE
MERSHIELD
STAYCLEAR

MB13
Bathscreen

SCAN FOR MORE INFORMATION

1500 MM
HEIGHT
6 MM
GLASS
THICKNESS
LIFETIME
GUARANTEE
MERSHIELD
STAYCLEAR

2 Panel Folding Curved

Size	Code	Panel	Product Adjustment	Price £ Exc. VAT	Price £ Inc. VAT
900 x 1500	MB3A	2	880 - 900	379.17	455.00

Features

- » Frameless screen
- » 6mm toughened safety glass
- » Reversible
- » Lifetime guarantee
- » Door swing - 90 degrees in and out

2 Panel Square

Size	Code	Panel	Product Adjustment	Price £ Exc. VAT	Price £ Inc. VAT
900 x 1500	MB3B	2	880 - 900	379.17	455.00

Features

- » Frameless screen
- » 6mm toughened safety glass
- » Reversible
- » Lifetime guarantee
- » Door swing - 90 degrees in and out

2 Panel Curved

Size	Code	Panel	Product Adjustment	Price £ Exc. VAT	Price £ Inc. VAT
900 x 1500	MB3C	2	880 - 900	382.50	459.00

Features

- » Frameless 6mm toughened safety glass
- » HydraSeal sealant
- » Reversible
- » Lifetime guarantee
- » Door swing - 90 degrees in and out

4 Fold

Size	Code	Panel	Product Adjustment	Price £ Exc. VAT	Price £ Inc. VAT
850 x 1400	MB4	4	845 - 850	455.00	546.00

Features

- » 4mm toughened safety glass
- » Mershield Stayclear™
- » Reversible
- » Easy storage
- » Lifetime guarantee

2 Panel Folding

Size	Code	Panel	Product Adjustment	Price £ Exc. VAT	Price £ Inc. VAT
1100 x 1500	MB13	2	1080 - 1100	600.00	720.00

Features

- » Frameless 6mm toughened safety glass
- » Mershield Stayclear™
- » Reversible
- » Lifetime guarantee
- » Door Swing: 180 degree radius of screen swing inwards and outwards

MB14
Bathscreen

SCAN FOR MORE INFORMATION

1500 MM
HEIGHT
SCREEN RANGE

8 MM
GLASS
THICKNESS

LIFETIME
GUARANTEE

MERSHIELD
STAYCLEAR

ECO FRIENDLY
PACKAGING

EASY CLEAN
GLASS

Brushed Brass

MERLYN Fixed Square

Size	Code	Colour Code	Panel	Product Adjustment	Price £ Exc. VAT	Price £ Inc. VAT
800 x 1500	MB14	Chrome only code	1	785-800	266.67	320.00
800 x 1500	MB14	add MB / BBR or BBZ	1	785-800	273.33	328.00

Features

- » 8mm toughened glass
- » Anodised aluminium finish - more durable than powder coating
- » Reversible
- » 4 Colour finishes
- » Lifetime Guarantee
- » Minimalist frameless design

When ordering your bath screen please add the desired colour code to the end of the standard chrome code.

Example: MB14 is the standard chrome code add **MB** for Matt Black, **BBR** for Brushed Brass or **BBZ** for Brushed Bronze.

E.G. MB14MB = MB14 Matt Black.



MB14F
Bathscreen

SCAN FOR MORE INFORMATION

1500 MM
HEIGHT
SCREEN RANGE

8 MM
GLASS
THICKNESS

LIFETIME
GUARANTEE

MERSHIELD
STAYCLEAR

ECO FRIENDLY
PACKAGING

EASY CLEAN
GLASS

Brushed Bronze

MERLYN Fixed Framed - Colour only

Size	Code	Colour Code	Panel	Product Adjustment	Price £ Exc. VAT	Price £ Inc. VAT
800 x 1500	MB14F	add MB / BBR or BBZ	1	775-790	375.83	451.00

Not available in chrome

Features

- » 8mm toughened glass
- » Anodised aluminium finish - more durable than powder coating
- » Reversible
- » Fully framed design
- » Lifetime Guarantee
- » 3 Colour finishes

When ordering your bath screen please add the desired colour code to the end of the standard chrome code.

Example: MB14F is the standard chrome code add **MB** for Matt Black, **BBR** for Brushed Brass or **BBZ** for Brushed Bronze.

E.G. MB14MB = MB14F Matt Black.



The following trays will be discontinued once stock is gone (S177RTTO / S1776RTTO). To be replaced by 1700 x 700 and 1700 x 760 trays.



Touchstone Tray

Design details



Graduated adjustable leg and easy-fit tray panel kit.



Adjustable leg system.



90mm fast flow waste, includes hair trap and chrome cover.



*Quadrant tray is handed – please choose L for Left Hand and R for Right Hand when ordering.

Riser kit can adjust to 85mm.



TOUCHSTONE

Beautifully sculpted shower trays, angled and contoured to match enclosures and spaces, achieving the perfect combination of luxury, elegance and durability.

features

- » Lifetime Guarantee
- » 50mm high to achieve minimalist design
- » Available as low level or with tray
- » panel kits for easy installation
- » Compatible 90mm fast flow waste also available
- » More than 30 sizes available

Rectangular & Square Trays (Waste sold separately)

Size	Code	Tray Panel Kit	Price £ Exc. VAT	Price £ Inc. VAT
700 x 700	S70SQTO	Kit 4	117.50	141.00
760 x 760	S76SQTO	Kit 4	116.67	140.00
800 x 800	S80SQTO	Kit 4	136.67	164.00
900 x 900	S90SQTO	Kit 4	152.50	183.00
800 x 700	S870RTTO	Kit 4	177.50	213.00
800 x 760	S876RTTO	Kit 4	177.50	213.00
900 x 700	S970RTTO	Kit 4	195.00	234.00
900 x 760	S976RTTO	Kit 4	195.00	234.00
900 x 800	S980RTTO	Kit 4	195.00	234.00
1000 x 700	S107RTTO	Kit 4	201.67	242.00
1000 x 760	S1076RTTO	Kit 4	201.67	242.00
1000 x 800	S108RTTO	Kit 4	201.67	242.00
1000 x 900	S109RTTO	Kit 4	209.17	251.00
1100 x 760	S1176RTTO	Kit 4	210.00	252.00
1100 x 800	S118RTTO	Kit 4	209.17	251.00
1100 x 900	S119RTTO	Kit 4	219.17	263.00
1200 x 700	S127RTTO	Kit 4	209.17	251.00
1200 x 760	S1276RTTO	Kit 4	220.00	264.00
1200 x 800	S128RTTO	Kit 4	232.50	279.00
1200 x 900	S129RTTO	Kit 4	250.83	301.00
1300 x 800	S138RTTO	Kit 3	325.83	391.00
1300 x 900	S139RTTO	Kit 3	341.67	410.00
1400 x 700	S147RTTO	Kit 3	339.17	407.00
1400 x 760	S1476RTTO	Kit 3	336.67	404.00
1400 x 800	S148RTTO	Kit 3	336.67	404.00
1400 x 900	S149RTTO	Kit 3	354.17	425.00
1500 x 700	S157RTTO	Kit 3	379.17	455.00
1500 x 760	S1576RTTO	Kit 3	395.83	475.00
1500 x 800	S158RTTO	Kit 3	400.83	481.00
1500 x 900	S159RTTO	Kit 3	416.67	500.00
1600 x 700	S167RTTO	Kit 3	447.50	537.00
1600 x 760	S1676RTTO	Kit 3	447.50	537.00
1600 x 900	S169RTTO	Kit 3	464.17	557.00
1680 x 760	S1776RTTO	Kit 3	494.17	593.00
1700 x 700	S177RTTON	Kit 3	479.17	575.00
1700 x 760	S1776RTTON	Kit 3	494.17	593.00
1700 x 800*	S178RTTO	Kit 3	538.33	646.00
1700 x 900*	S179RTTO	Kit 3	580.00	696.00
1800 x 700	S187RTTO	-	620.83	745.00
1800 x 800*	S188RTTO	-	662.50	795.00
1800 x 900	S189RTTO	-	681.67	818.00

*Waste is centred long side on 1700x800 & 1700x900 & 1800x800 trays. See Page 23 for Tray Panel Kit Information.

Quadrant Tray (Waste sold separately)

Size	Code	Tray Panel Kit	Price £ Exc. VAT	Price £ Inc. VAT
800 x 800	S80QTO	Kit 2	144.17	173.00
900 x 900	S90QTO	Kit 2	161.67	194.00
1000 x 1000	S100QTO	Kit 2	186.67	224.00

Offset Quadrant Tray (Waste sold separately)

Size	Code	Tray Panel Kit	Price £ Exc. VAT	Price £ Inc. VAT
*900 x 760 LH	S976QLTO	Kit 1	196.67	236.00
*900 x 760 RH	S976QRTO	Kit 1	196.67	236.00
*1000 x 800 LH	S108QLTO	Kit 1	221.67	266.00
*1000 x 800 RH	S108QRTO	Kit 1	221.67	266.00
*1200 x 800 LH	S128QLTO	Kit 1	232.50	279.00
*1200 x 800 RH	S128QRTO	Kit 1	232.50	279.00
*1200 x 900 LH	S129QLTO	Kit 1	275.83	331.00
*1200 x 900 RH	S129QRTO	Kit 1	275.83	331.00

This product is handed – please choose L for Left Hand and R for Right Hand when ordering. White Waste Cap is for Touchstone trays only. Waste cap comes in chrome as standard. See page 23 for DWAS waste.

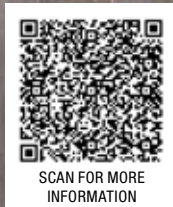

SCAN FOR MORE INFORMATION

Waste Caps

NEW!

Description	Code	Price £ Exc. VAT	Price £ Inc. VAT
White	DWASCAPWHT	20.83	25.00
Matt Black	DWASCAPMB	28.33	34.00
Brushed Gun Metal	DWASCAPBGM	28.33	34.00
Brushed Bronze	DWASCAPBBZ	28.33	34.00
Brushed Brass	DWASCAPBBR	28.33	34.00
Brushed Nickel	DWASCAPBN	28.33	34.00

DWAS caps are now available in Matt Black (MB) / Brushed Brass (BBR) / Brushed Bronze (BBZ) / Brushed Gun Metal (BGM) and Brushed Nickel (BN). Chrome comes as standard.

The following tray will be discontinued once stock is gone (S177RTASTO). To be replaced by 1700 x 700 tray.



Touchstone-SR Tray

Design details



Graduated adjustable leg and easy-fit tray panel kit.



Adjustable leg system.



90mm fast flow waste, includes hair trap and chrome cover.



*Quadrant tray is handed – please choose L for Left Hand and R for Right Hand when ordering.

Riser kit can adjust to 85mm.

TOUCHSTONE-SR

We have carried out all the testing to give you and your family the peace of mind of showering in a safe environment and the splendour of this natural stone effect.

features

- » Lifetime Guarantee
- » 50mm high to achieve minimalist design
- » Available as low level or with tray panel kits for easy installation
- » Slip-resistant is manufactured into the coating and won't wear
- » Compatible 90mm fast flow waste also available
- » More than 30 sizes available

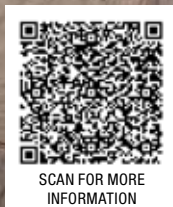
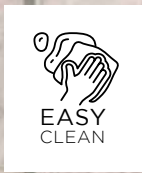

Rectangular & Square Trays (Waste sold separately)

Size	Code	Tray Panel Kit	Price £ Exc. VAT	Price £ Inc. VAT	
800 x 800	S80SQASTO	Kit 4	188.33	226.00	
900 x 900	S90SQASTO	Kit 4	213.33	256.00	
900 x 800	S980RTASTO	Kit 4	272.50	327.00	
1000 x 800	S108RTASTO	Kit 4	280.83	337.00	
1000 x 900	S109RTASTO	Kit 4	291.67	350.00	
1100 x 800	S118RTASTO	Kit 4	291.67	350.00	
1200 x 700	S127RTASTO	Kit 4	291.67	350.00	
1200 x 760	S1276RTASTO	Kit 4	306.67	368.00	
1200 x 800	S128RTASTO	Kit 4	324.17	389.00	
1200 x 900	S129RTASTO	Kit 4	348.33	418.00	
1400 x 700	S147RTASTO	Kit 3	466.67	560.00	
1400 x 800	S148RTASTO	Kit 3	466.67	560.00	
1400 x 900	S149RTASTO	Kit 3	491.67	590.00	
1500 x 760	S1576RTASTO	Kit 3	548.33	658.00	
1500 x 800	S158RTASTO	Kit 3	550.83	661.00	
1500 x 900	S159RTASTO	Kit 3	576.67	692.00	
1600 x 700	S167RTASTO	Kit 3	615.83	739.00	
1600 x 800	S168RTASTO	Kit 3	615.83	739.00	
1600 x 900	S169RTASTO	Kit 3	642.50	771.00	
1700 x 700	S177RTASTON	Kit 3	663.33	796.00	NEW!
*1700 x 800	S178RTASTO	Kit 3	744.17	893.00	
*1700 x 900	S179RTASTO	Kit 3	801.67	962.00	
1800 x 700	S187RTASTO	-	848.33	1018.00	NEW!
*1800 x 800	S188RTASTO	-	886.67	1064.00	NEW!
1800 x 900	S189RTASTO	-	887.50	1065.00	NEW!

*Waste is centred long side on 1700x800 & 1700x900 & 1800x800 trays.

Quadrant Tray (Waste sold separately)

Size	Code	Tray Panel Kit	Price £ Exc. VAT	Price £ Inc. VAT
800 x 800	S80QASTO	Kit 2	205.00	246.00
900 x 900	S90QASTO	Kit 2	226.67	272.00
*1000 x 800 LH	S108QLASTO	Kit 1	295.00	354.00
*1000 x 800 RH	S108QRASTO	Kit 1	295.00	354.00
*1200 x 800 LH	S128QLASTO	Kit 1	324.17	389.00
*1200 x 800 RH	S128QRASTO	Kit 1	324.17	389.00
*1200 x 900 LH	S129QLASTO	Kit 1	383.33	460.00
*1200 x 900 RH	S129QRASTO	Kit 1	383.33	460.00

This product is handed – please choose L for Left Hand and R for Right Hand when ordering.

Tray Panel Kit

Tray Panel Kit	Code	Price £ Exc. VAT	Price £ Inc. VAT
Kit 1	DRK1	145.83	175.00
Kit 2	DRK2	145.83	175.00
Kit 3	DRK3	144.17	173.00
Kit 4	DRK4	140.83	169.00

DWAS Waste (sold separately)

	Code	Price £ Exc. VAT	Price £ Inc. VAT
Complete Waste	DWAS	40.83	49.00

Waste Caps

NEW!

Description	Code	Price £ Exc. VAT	Price £ Inc. VAT
White	DWASCAPWHT	20.83	25.00
Matt Black	DWASCAPMB	28.33	34.00
Brushed Gun Metal	DWASCAPBGM	28.33	34.00
Brushed Bronze	DWASCAPBBZ	28.33	34.00
Brushed Brass	DWASCAPBBR	28.33	34.00
Brushed Nickel	DWASCAPBN	28.33	34.00

DWAS caps are now available in Matt Black (MB) / Brushed Brass (BBR) / Brushed Bronze (BBZ) / Brushed Gun Metal (BGM) and Brushed Nickel (BN). Chrome comes as standard.

Tray Waste Positions & Product Information

We have produced this product section to help you with your purchasing decision. For further information please contact your local stockist, details of which can be found at www.merlynshowering.com

Touchstone Trays

Shape	Size	Waste Position A, mm	Waste Position B, mm
Square	A	B	
	760	148	148
	800	148	148
	900	148	148

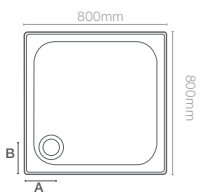

Rectangle	A	B
	800 x 700	148 148
	800 x 760	148 148
	900 x 700	148 148
	900 x 760	148 148
	900 x 800	148 148
	1000 x 700	148 148
	1000 x 760	148 148
	1000 x 800	148 148
	1000 x 900	148 148
	1100 x 760	148 148
	1100 x 800	148 148
	1100 x 900	148 148
	1200 x 700	148 148
	1200 x 760	148 148
	1200 x 800	148 148
	1200 x 900	148 148
	1300 x 800	148 148
	1300 x 900	148 148

Touchstone Trays - Continued

Shape	Size	Waste Position A, mm	Waste Position B, mm
Rectangle	A	B	
	1400 x 700	148	148
	1400 x 760	148	148
	1400 x 800	148	148
	1400 x 900	148	148
	1500 x 700	148	148
	1500 x 760	148	148
	1500 x 800	148	148
	1500 x 900	148	148
	1600 x 700	148	148
	1600 x 760	148	148
	1600 x 800	148	148
	1600 x 900	148	148
	1685 x 700	148	148
	1680 x 760	148	148
	1600 x 900	148	148
	1685 x 700	148	148
	1700 x 800	130	850
	1700 x 900	130	850
	1800 x 760	130	900
	1800 x 800	130	900
	1800 x 900	130	900

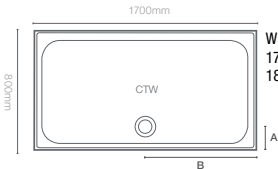

Waste is centred for 1700 x 800 / 1700 x 900 / 1800 x 700 / 1800 x 800 & 1800 x 900 trays

Touchstone Trays - Continued

Shape	Size	Waste Position A, mm	Waste Position B, mm
Quad	A	B	
	800	250	130
	900	350	130

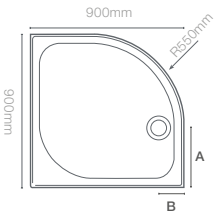

Offset Quad	A	B
	1000 x 800	350 130
	1200 x 800	450 130
	1200 x 900	450 130

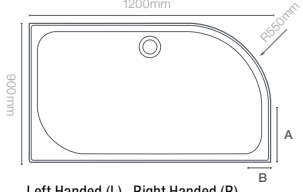

Left Handed (L) Right Handed (R)
Product is handed. Please choose L for Left or R for Right when ordering

Product Information

Product information

All products are manufactured in accordance with EN14428 and utilise toughened safety glass to EN 12150.
All shower trays are manufactured in accordance with EN14527.
All doors feature adjustable wall profiles to compensate for out-of-true walls and have micro adjustment features for fine tuning to obtain a perfect fit and operating action.
All enclosures, wetrooms and panels are Power Shower approved – will retain water under normal showering conditions.
Water retention is maintained in all products under normal showering conditions.
A selection of MERLYN enclosures are frameless in design. Spray/mist may escape therefore we would recommend use of these enclosures with tiled floors.
Opened cartons can not be returned. Returns carry a £40 box charge or £60 per unit where the sale is less than 30 days old. Returns over 30 days old will not be accepted.
All products are supplied complete with full installation instructions and the necessary fixings.
Check with your dealer for accurate matching of material samples. Product descriptions do not imply the use of precious or valuable materials.

Our policy of reviewing product design and development on a regular basis means MERLYN reserve the right to change product specifications and prices without notice.
Only shower enclosures, panels, Truestone shower trays and bath screens are covered by the Lifetime Guarantee. Please contact the MERLYN sales team for more details.
Glass shattering and parts subject to wear are not covered by the Lifetime Guarantee.
For full details on all product ranges please contact MERLYN Showering on 0808 1011429 or log onto www.merlynshowering.com.
Trays shown in this catalogue are for illustrative purposes only.

Images are for illustration purposes only.

The colours and finishes shown in the catalogue are as accurate as possible within the limits of the printing process. The positioning of all showering heads in the brochure is for illustrative purposes only.
All descriptions, specifications and particulars contained in this brochure are intended merely to represent a general idea of the products described herein and none of these form part of any contract to give rise to any independent or collateral liability upon the company.

Cleaning

- » It is important to clean your MERLYN shower door and tray after every use. Wipe down all the glass and metal parts with a soft cloth.
- » Do not allow lime scale to build up in hard water areas.
- » Ensure that any residual water on the glass is removed after every use.
- » Clean the glass regularly using soapy water.
- » Do not use abrasive products on any surfaces.
- » Install the enclosure in a well ventilated area.

Information and maintenance

Always read the instructions on the packaging, chrome is vulnerable to acid attack and some strong household cleaners including strong disinfectants, denture cleaners, hair dyes, wine making chemicals and photographic chemicals may contain acid. These materials may have a varying effect on the surface from black spots/streaks (which cannot be removed) to pitting the surface. Contact with these materials should be avoided.

Important shower tray information

It is up to the designer or installer to ensure that the tray and enclosure combination is arranged in such a way that water retention meets the customers needs.

- » The waste has the capacity to carry away 27L/Min. High powered systems may exceed this. Please check with the manufacturer.
- » Please ensure that the shower head is not positioned directly over the waste as this may restrict water flow rate.
- » Please ensure that the colour and size of shower tray are as per your order before installation.
- » You must inspect the product thoroughly before installation. Fitting the product is acceptance of quality.
- » The trays are handmade from natural material. Please allow for height variances due to manufacturing tolerances.
- » For open ended shower screens please consult your installer.
- » MERLYN shower trays are manufactured in accordance with BS EN 14527, which includes testing for thermal shock using water temperatures of 12°C and 75°C. MERLYN recommends that water temperature does not exceed 60°C during use. Exposure to water temperatures above 75°C may cause thermal shock and result in permanent damage to the tray. Any damage caused by water temperatures exceeding these limits is not covered under warranty.
- » Shower trays must be fitted as per the fitting instruction. Deviation from the pre installation checks or fitting installation will void the guarantee.
- » When wet, the surface of the majority of shower trays will show an increase in the potential for slipping. This is

particularly the case when soap, shampoo, bath oil etc. are used. It is important that designers, installers and users are aware of this.

Important

Although shower door and enclosure sizes are related to tray sizes it is important to note that most shower trays are tiled down to the rim, often over an 'up-stand'. The finished installation space may be less than the nominal tray size. MERLYN shower units are made to suit this remaining space.

Tray Finish min-max

The Tray Finish applies when fitting a door and a tray. These are the minimum and maximum dimensions that a shower door or enclosure will fit using standard wall profiles.

Tray finish

To find the correct Tray Finish dimension:

In a recess: Measure from the finished, tiled wall to the opposite finished, tiled wall.

In a corner: Measure from the finished, tiled wall to the edge of the tray.

Note: If the wall/walls are leaning in, this will further reduce your Tray Finish.

Adjustment

This is the min and max adjustment of the actual enclosure. These are the adjustment dimensions of the actual door excluding the tray. Therefore, these are the dimensions to follow when installing a enclosure in a wetroom application without a tray.

The guide below may be helpful in taking measurements to determine the shower door or enclosure size required. Dimensions given in this publication are in millimetres, are approximate and may vary with adjustment. They are subject to change without notice.

Please note that when a tray is fitted it is essential that the tray is level before any doors or enclosures are fitted.

Recess Location

Take the measurements after the tray is installed and the walls are tiled.

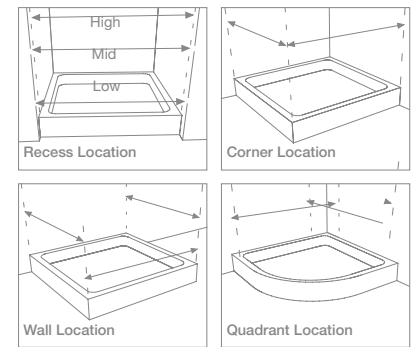

Bath Screens

- » MERLYN Bath Screens are not designed to fit on baths with stepped fronts, roll top rims or integral soap dishes.
- » Fitting of screen on baths which have raised head rests or shapes is not recommended.
- » There must be no items causing obstruction with the seal and bath, as any of the above may cause leaks.
- » When choosing your Bath Screen, please ensure that if your bath has bath handles, they do not interfere with the bath rim area where your screen will be placed.
- » When choosing an in-swing or folding Bath Screen, please ensure your swing area is not interfering with any brassware or internal shower features. Similarly, when choosing an out-swing, please ensure the out-swing area is free from any obstructions.
- » It is recommended the shower head position is situated on the same wall to which the Bath Screen is fixed and in the centre of the shower area.

UKCA, CE & EN Information

The UKCA (UK Conformity Assessment) mark on MERLYN enclosures is the new standard marking for products on the market in Great Britain (England, Wales and Scotland). It is a declaration that the product complies with GB designated standards.

The CE markings on MERLYN enclosures is a declaration that the product complies with the essential requirements of the relevant European health, safety and environmental protection legislation.

EU and GB legislation requires manufacturers to display either the UKCA mark for Great Britain and a CE mark for the EU and Northern Ireland on their product or packaging. It is an offence to place a product on the relevant market without a UKCA for Great Britain or CE marking for the EU market.

The manufacturer is legally responsible for ensuring that the product conforms to the requirements of both directives.

The European Commission thus refers to the CE marking as a "Passport" which allows products to be freely circulated within the EU single market. The UKCA marking allows products to move freely within Great Britain.

Often consumers will consider the UKCA and CE markings on a product as an indication of conformance to laid down minimum standards and therefore, a minimum level of safety which other products may lack. Both markings are often seen by consumers as a "Symbol of Safety."

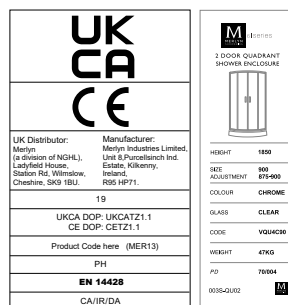

MERLYN invests heavily in its product development and as such guarantees that its glass fully complies with regulations and is manufactured in accordance with BS EN 14428. The rigorous testing of the glass ensures that the endurance, stability and water retention criteria meet high industry standards.

New GB, EU and NI label

ISO Certification

MERLYN has implemented an Integrated Management System comprising of Quality Management, Environmental Management and Occupational Health and Safety Management. An Integrated Management System ensures the seamless integration of several different standards into a common system that meets the requirements of each of these standards. These certifications are proof of MERLYN's credibility but also to instil confidence in our potential consumers that MERLYN will keep its promises.



Brochure Recycling

Please be aware our cover is non recyclable. Remove cover before recycling the internal pages.

MERLYN™

Unit 8, Purcellsinch Industrial Estate, Dublin Road,
Kilkenny, Ireland, R95 HP71.

Telephone: 0808 1011 429
Whatsapp: + 353 860 100 002

Email:
Sales: sales@merlyn.ie
Technical: technical@merlyn.ie
www.merlynshowering.com



MBOX SHOWER ENCLOSURES

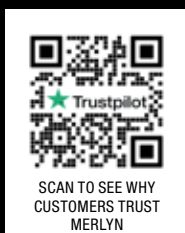

SCAN TO SEE WHY
CUSTOMERS TRUST
MERLYN

