

# KUDOS

SHOWERING SOLUTIONS



SHOWROOM COLLECTION

RONAL Bathrooms UK



# KUDOS

SHOWERING SOLUTIONS



## SHOWROOM COLLECTION

RONAL Bathrooms UK.



pinnacle8 brushed brass sliding corner enclosure.



SHOWROOM COLLECTION

# KUDOS

SHOWERING SOLUTIONS

## Design and functionality in harmony

The perfect combination of sophisticated minimalism and modern elegance. The Showroom Collection brochure showcases our most luxurious product ranges.

Whether you're looking for understated elegance or want to make a statement, we have something that will suit every bathroom.

The Kudos Showroom Collection is available only to purchase from the network of Kudos Showroom Collection Retailers.

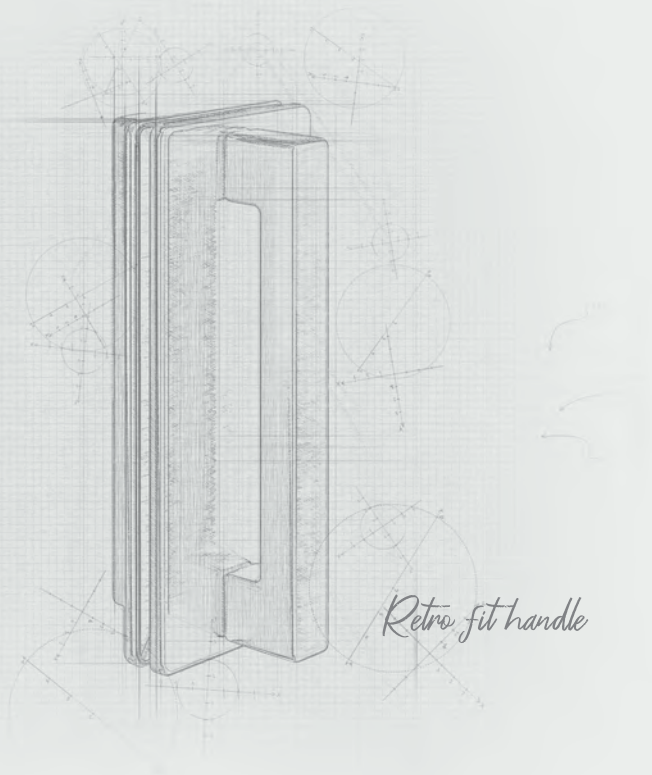



1200mm corner straight sliding door

SHOWROOM COLLECTION

# siona

collection

---

## Minimalism with a traditional aesthetic

The siona 8mm range, is semi-frameless and includes pivot and straight sliding door options.

This stunning range is available in chrome, matt black and brushed brass finishes as standard, selected products\* in the range are also available in gun metal, brushed copper and brushed nickel. The siona range combines understated minimalism with a traditional aesthetic, giving you the flexibility to create a bathroom space that will stand the test of time.

All of the products in the siona range are 2000mm high, feature 8mm toughened safety glass throughout and are covered by the Kudos Lifetime Guarantee giving you complete peace of mind.

*\*Applies to siona walk-in enclosures only*

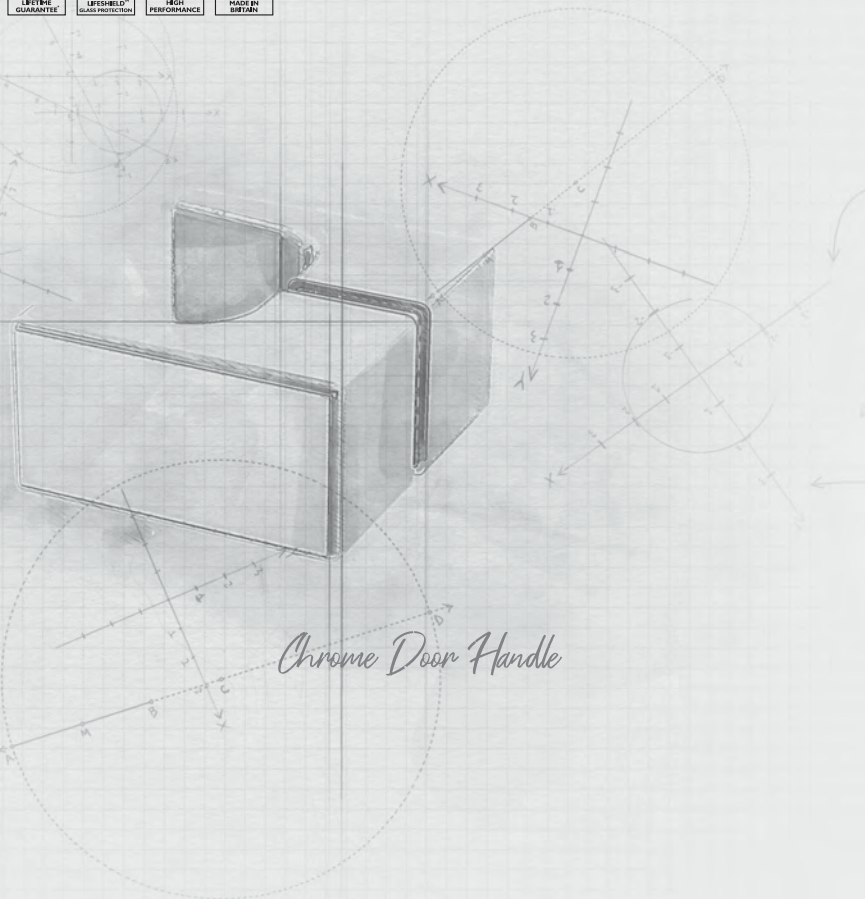

**SHOWROOM** COLLECTION

# siona

pivot corner doors

---

The semi-frameless siona pivot door features a barrel pivot mechanism and crystal clear seals throughout and includes corner and recess door options.

Combining the benefits of a fully framed enclosure with the aesthetic of frameless enclosures, the siona pivot door is perfect for medium to large bathrooms.

Chrome left handed, pivot corner enclosure on a connect2 tray.



## Features

- + 2000mm high
- + 8mm toughened safety glass
- + Crystal clear seals
- + Barrel pivot mechanism
- + Concealed fittings throughout
- + Lifeshield protection for easy cleaning
- + Available in chrome, matt black and brushed brass
- + Lifetime Guarantee
- + Made In Britain

## Layout

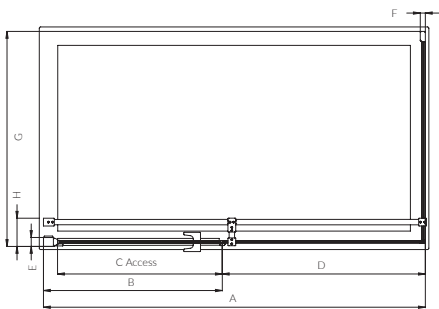

Pivot corner doors can be fitted to open either to the left or right by rotating the enclosure 180°



Support bar

## Codes & Dimensions

Door Size	*Product Code	Adjustments (mm)	Dimensions (mm)					
		A	B	C	D	E	F	H
800mm	SNPCP80	775-795	635-655	585	137	32	18	102
900mm	SNPCP90	875-895	635-655	585	237	32	18	102
1000mm	SNPCP100	975-995	635-655	585	337	32	18	102
1200mm	SNPCP120	1175-1195	635-655	585	537	32	18	102

**Door Height:** 2000 mm excluding tray (2025mm Inc. Support Bar)

\*When ordering matt black please add **MBK** to product codes and for brushed brass add **BRG**

## Side Panels

Panel Size	Product Code	Adjustments (mm)
		G
760mm	SNPC76	735-755
800mm	SNPC80	775-795
900mm	SNPC90	875-895



Matt black left handed, pivot corner enclosure on a connect2 tray.

SHOWROOM COLLECTION

# siona

pivot recess doors

---

The semi-frameless siona pivot door features a barrel pivot mechanism and crystal clear seals throughout and includes corner and recess door options.

Combining the benefits of a fully framed enclosure with the aesthetic of frameless enclosures, the siona pivot door is perfect for medium to large bathrooms.

Matt black recess pivot door enclosure



## Features

- + 2000mm high
- + 8mm toughened safety glass
- + Crystal clear seals
- + Barrel pivot mechanism
- + Concealed fittings throughout
- + Lifeshield protection for easy cleaning
- + Available in chrome, matt black and brushed brass
- + Lifetime Guarantee
- + Made In Britain

## Layout

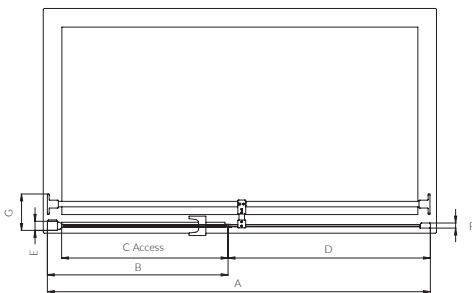

Pivot recess doors can be fitted to open either to the left or right by rotating the door 180°



Chrome door handle

## Codes & Dimensions

Door Size	*Product Code	Adjustments (mm)	Dimensions (mm)					
		A	B	C	D	E	F	G
800mm	SNPR80	765-805	635-655	585	137	32	18	130
900mm	SNPR90	865-905	635-655	585	257	32	18	130
1000mm	SNPR100	965-1005	635-655	585	357	32	18	130
1200mm	SNPR120	1165-1205	635-655	585	557	32	18	130
1400mm	SNPR140	1365-1405	635-655	585	757	32	18	130

**Door Height:** 2000 mm excluding tray (2025mm Inc. Support Bar)

\*When ordering matt black please add **MBK** to product codes and for brushed brass add **BRG**



Chrome recess pivot door enclosure

## SHOWROOM COLLECTION

# siona

sliding corner doors

---

The siona sliding door can be used to create corner or recess enclosures up to 1500mm wide, this stunning enclosure features a double roller for a smooth sliding action.

The siona sliding door can be installed to open either to the left or right and when installed with a Kudos connect2 tray, is the perfect solution for a medium to large bathroom space.

Chrome corner sliding door enclosure



**Features**

- + 2000mm high
- + 8mm toughened safety glass
- + Crystal clear seals
- + Double roller mechanism
- + Concealed fittings throughout
- + Suitable for corner, recess and 3 sided installations
- + Lifeshield protection for easy cleaning
- + Available in chrome, matt black and brushed brass
- + Lifetime Guarantee
- + Made In Britain

**Layout**

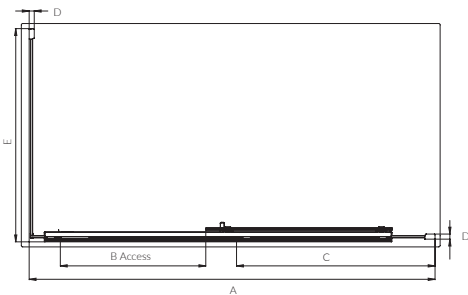

Sliding corner doors can be fitted to open either to the left or right by rotating the door 180°



Sliding door mechanism

**Codes & Dimensions**

Door Size	*Product Code	Adjustments (mm)	Dimensions (mm)			
		A	B	C	D	
1200mm	SNS120	1155-1175	430	513-533	18	
1400mm	SNS140	1355-1375	530	613-633	18	
1500mm	SNS150	1455-1475	530	713-733	18	

**Door Height:** 2000mm excluding tray (2025mm Inc. Support Bar)

\*When ordering matt black please add **MBK** to product codes and for brushed brass add **BRG**

**Side Panels**

Panel Size	Product Code	Adjustments (mm)
		E
760mm	SNSC76	725-745
800mm	SNSC80	765-785
900mm	SNSC90	865-885



Matt black corner sliding door enclosure

**SHOWROOM** COLLECTION

# siona

sliding recess doors

---

The siona sliding door can be used to create corner, recess or 3 sided enclosures up to 1500mm wide, this stunning enclosure features a double roller for a smooth sliding action.

The siona sliding door can be installed to open either to the left or right and, when installed with a Kudos connect2 tray, is the perfect solution for a medium to large bathroom space.

Matt black recess sliding door enclosure



**Features**

- + 2000mm high
- + 8mm toughened safety glass
- + Crystal clear seals
- + Double roller mechanism
- + Concealed fittings throughout
- + Suitable for corner, recess and 3 sided installations
- + Lifeshield protection for easy cleaning
- + Available in chrome, matt black and brushed brass
- + Lifetime Guarantee
- + Made In Britain

**Layout**

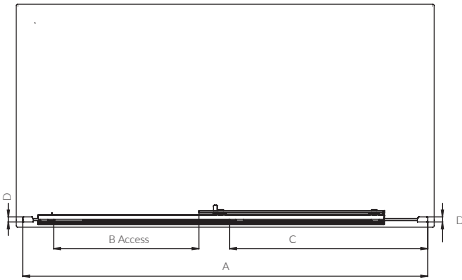

Sliding recess doors can be fitted to open either to the left or right by rotating the door 180°



Chrome door handle

**Codes & Dimensions**

Door Size	*Product Code	Adjustments (mm)	Dimensions (mm)		
		A	B	C	D
1200mm	SNS120	1155-1175	430	513-533	18
1400mm	SNS140	1355-1375	530	613-633	18
1500mm	SNS150	1455-1475	530	713-733	18

**Door Height:** 2000mm excluding tray (2025mm Inc. Support Bar)

\*When ordering matt black please add **MBK** to product codes and for brushed brass add **BRG**



Chrome recess sliding door enclosure

## SHOWROOM COLLECTION

siona  
walk-ins

Chrome corner walk in enclosure

Whether you're creating a minimalist spa-style bathroom or are looking to future proof your space with a low level, easy access, enclosure the Siona walk-in range represents the perfect solution.

Competitively priced and easy to install, this range features 8 panel sizes from 700-1400mm and is now 6 available in colour finishes.

Suitable for installation either on aqua4ma or a Kudos shower tray such as connect2, the siona walk-in range offers flexibility and gives you the opportunity to create the configuration that is perfect for your bathroom space.



**Features**

- + 2000mm high
- + 8mm toughened safety glass
- + 8 panel sizes
- + 2 deflector options
- + Available in 6 colour finishes: Chrome, matt black, brushed brass, brushed copper, brushed gun metal and brushed nickel
- + Can be used to create corner and recess configurations
- + LifeShield protection for easy cleaning
- + Lifetime Guarantee

**Deflector Panels**

Style	Product Code**	Deflector Length (mm)	Dimensions (mm)		
			A	B	C
Foldaway Deflector (0-180°)	SNFAD42	378	416	18	
Hinged Deflector (90-270°)	SNHIND42	378	407	18	

**Foldaway Deflector**

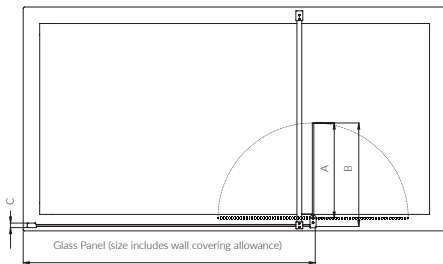

**Hinged Deflector**

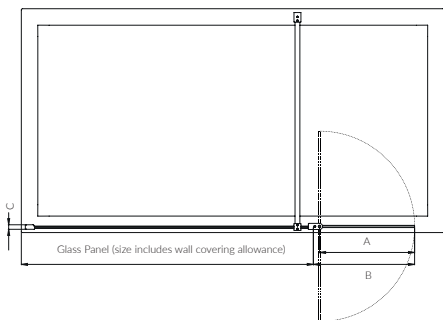

**Codes & Dimensions**

Panel Sizes*	Product Code 8mm Glass
700mm Glass Panel	SNWPI70
760mm Glass Panel	SNWPI76
800mm Glass Panel	SNWPI80
900mm Glass Panel	SNWPI90
1000mm Glass Panel	SNWPI100
1100mm Glass Panel	SNWPI110
1200mm Glass Panel	SNWPI120
1400mm Glass Panel	SNWPI140
Glass to Glass Corner Seal	SNWPCS

\*Sizes shown are nominal. All panels are undersized by 45mm to allow for tiling when fitting to shower trays. When choosing your panel size we recommend allowing access of approx. 500mm.

**Note: Pack includes glass panel, wallpost, support bar and T piece.**

**Please note** that whilst deflector panels will contain a significant amount of overspray, they are not intended to be watertight so some water may leave the showering area (particularly with smaller configurations)

Accessories	Product Code**
Glass to Ceiling Stabilising Pack (600mm rail)	SNWPGC60
Angled Fixing Bracket (300mm)	SNWPGW30

\*\*When ordering please add **MBK** (matt black), **BRG** (brushed brass), **BRN** (brushed nickel), **BGM** (brushed gun metal) and **BRC** (brushed copper) to the product codes

**Available Colour Finishes ††**



†† Colour Finish options may vary according to selected range.



Brushed copper corner walk in enclosure



1000mm x 1000mm quadrant enclosure.

SHOWROOM COLLECTION

# pinnacle8

collection

---

## The difference is in the detail

The pinnacle8 range of enclosures represents new heights in shower enclosure design, with all products now available in three colour finishes, combining our iconic design with timeless elegance.

Featuring hinged, sliding, quadrant, centre fold and level access options, the pinnacle8 collection is characterised by a minimalist finger pull and easy fit wall posts with concealed fixings throughout. Manufactured in the beautiful Lake District, the pinnacle8 range is 2000mm high and is backed by the Kudos Lifetime Guarantee against material or manufacturing defects for your complete peace of mind.



*Rise & fall hinge*

SHOWROOM COLLECTION

# pinnacle8

hinged corner doors

---

The pinnacle8 hinged door is available in chrome, matt black or brushed brass and in sizes ranging from 760mm to 1500mm.

Featuring stylish rise and fall hinges, minimalist design with crystal clear seals, pinnacle8 will enhance any bathroom design.

Matt black hinged corner, left handed, on a slate effect connect2 tray.



**Features**

- + 8mm toughened safety glass
- + 2000mm high
- + Concealed fixings
- + Slimline profile with 20mm wall adjustment
- + Lifeshield™ Glass Protection
- + Crystal clear glass to glass seals
- + Die cast rise and fall hinges
- + Frameless side panels
- + Available in chrome, matt black and brushed brass
- + Lifetime Guarantee
- + Made in Britain

**Layout**

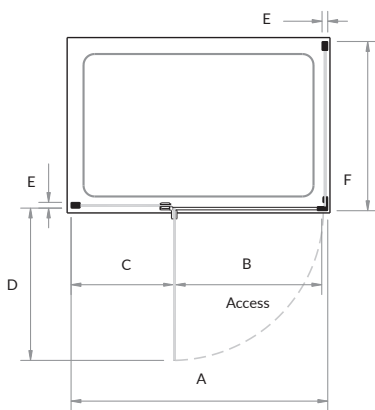

Hinged corner doors are supplied left hand or right hand



Brushed brass rise and fall hinge

**Codes & Dimensions §**

Door Size	***Product Code	Dimensions (mm)					
		A	B	C	D	E	F
760mm	P8HC76	730-750	530	168-188	555	26	-
800mm	P8HC80	770-790	570	168-188	595	26	-
900mm	P8HC90	870-890	670	168-188	695	26	-
1000mm	P8HC100	970-990	670	268-288	695	26	-
1100mm	P8HC110	1070-1190	570	468-488	595	26	-
1200mm	P8HC120	1170-1190	670	468-488	695	26	-
1300mm	P8HC130	1270-1290	570	668-688	595	26	-
1400mm	P8HC140	1370-1390	670	668-688	695	26	-
1500mm	P8HC150	1470-1490	670	768-788	695	26	-

**Side Panels**

700mm	P8HC2SP70	-	-	-	-	26	670-690
760mm	P8HC2SP76	-	-	-	-	26	730-750
800mm	P8HC2SP80	-	-	-	-	26	770-790
900mm	P8HC2SP90	-	-	-	-	26	870-890
1000mm	P8HC2SP100	-	-	-	-	26	970-990
1200mm	P8HC2SP120	-	-	-	-	26	1170-1190

\*\*\*Please add **L** or **R** to the product code to indicate left or right handed door.

When ordering matt black please add **MBK** to product codes and for brushed brass add **BRG**

§ **N.B** Hinged Doors for Recess and Corner are not interchangeable

**Optional Items**

Product	Product Code
*Angled Stabilising Bracket for Doors (1000 & 1100mm)	P8SB22
*Angled Stabilising Bracket for Doors 1200mm+	P8SB32
**Retro Fit Handle	P8RH
† 10mm Extension Post	P8SOS

\* An optional angled stabilising bracket is available for larger doors if additional stability is required.

\*\*An optional handle is available if required.

Both angled bracket and handle can be retro fitted and only need to be purchased if preferred.

† All doors and side panels can be extended in 10mm increments with an extension post (to a maximum of 20mm/ 2 posts per fixed panel side only)

SHOWROOM COLLECTION

# pinnacle8

hinged recess doors

---

The pinnacle8 hinged door is available in chrome, matt black and brushed brass in sizes ranging from 760mm to 1500mm.

Featuring stylish rise and fall hinges, minimalist design with crystal clear seals, pinnacle8 will enhance any bathroom design.

Chrome recess right hand hinged door on a connect2 tray.



**Features**

- + 8mm toughened safety glass
- + 2000mm high
- + Concealed fixings
- + Slimline profile with 20mm wall adjustment
- + Lifeshield™ Glass Protection
- + Crystal clear glass to glass seals
- + Die cast rise and fall hinges
- + Available in chrome, matt black and brushed brass
- + Lifetime Guarantee
- + Made in Britain

**Layout**

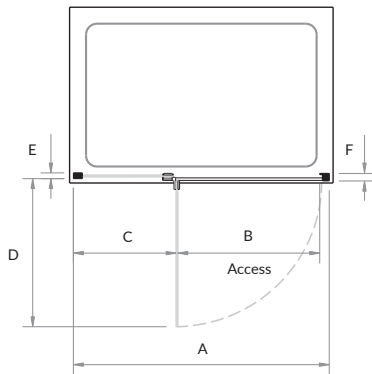

Hinged recess doors are supplied left hand or right hand



Retro fit handle

**Codes & Dimensions §**

Door Size	***Product Code	Dimensions (mm)					
		A	B	C	D	E	F
760mm	P8HR76	725-765	505	168-188	534	26	34
800mm	P8HR80	765-805	545	168-188	574	26	34
900mm	P8HR90	865-905	645	168-188	674	26	34
1000mm	P8HR100	965-1005	545	268-288	674	26	34
1100mm	P8HR110	1065-1105	545	468-488	574	26	34
1200mm	P8HR120	1165-1205	645	468-488	674	26	34
1300mm	P8HR130	1265-1305	545	668-688	574	26	34
1400mm	P8HR140	1365-1405	645	668-688	674	26	34
1500mm	P8HR150	1465-1505	645	768-788	674	26	34

\*\*\*Please add **L or R** to the product code to indicate left or right handed door.

When ordering matt black please add **MBK** to product codes and for brushed brass add **BRG**

§ **N.B** Hinged Doors for Recess and Corner are not interchangeable

**Optional Items**

Product	Product Code
*Angled Stabilising Bracket for Doors (1000 & 1100mm)	P8SB22
*Angled Stabilising Bracket for Doors 1200mm+	P8SB32
**Retro Fit Handle	P8RH
† 10mm Extension Post	P8SOS

\* An optional angled stabilising bracket is available for larger doors if additional stability is required.

\*\*An optional handle is available if required.

Both angled bracket and handle can be retro fitted and only need to be purchased if preferred.

† All doors and side panels can be extended in 10mm increments with an extension post (to a maximum of 20mm/ 2 posts per fixed panel side only)

SHOWROOM COLLECTION

# pinnacle8

level access hinged corner doors

---

The pinnacle8 level access hinged door is available in sizes ranging from 800mm to 1200mm with side panels from 700mm to 1200mm. Stylish rise and fall hinges, minimalist frameless design with crystal clear seals, pinnacle8 will enhance any bathroom design.

Level access right hand chrome hinged corner enclosure



**Features**

- + 8mm toughened safety glass
- + 2000mm high
- + Level access
- + Slimline profile with 20mm wall adjustment
- + Lifeshield™ Glass Protection
- + Crystal clear glass to glass seals
- + Die cast rise and fall hinges
- + Frameless side panels
- + Optional retro fit handle
- + Available in chrome, matt black and brushed brass
- + Lifetime Guarantee
- + Made in Britain

**Layout**

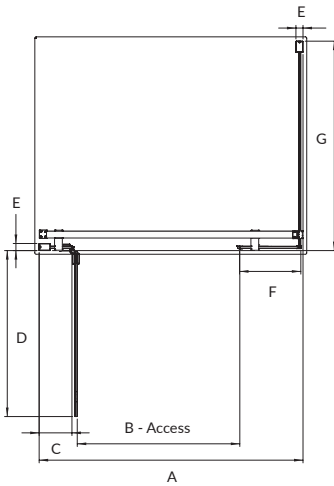

Hinged corner doors are supplied left hand or right hand



Stabilising Bar

**Codes & Dimensions**

Door Size	***Product Code	Dimensions (mm)						
		A	B	C	D	E	F	G
800mm	P8FH80L	770-790	500	120-140	509	26	125	
800mm	P8FH80R	770-790	500	120-140	509	26	125	
900mm	P8FH90L	870-890	600	120-140	609	26	125	
900mm	P8FH90R	870-890	600	120-140	609	26	125	
1000mm	P8FH100L	970-990	600	120-140	609	26	225	
1000mm	P8FH100R	970-990	600	120-140	609	26	225	
1100mm	P8FH110L	1070-1100	600	120-140	609	26	325	
1100mm	P8FH110R	1070-1100	600	120-140	609	26	325	
1200mm	P8FH120L	1170-1190	600	120-140	609	26	425	
1200mm	P8FH120R	1170-1190	600	120-140	609	26	425	

**Side Panels**

700 mm	P8FHSP70	-	-	-	-	26	-	670-690
760 mm	P8FHSP76	-	-	-	-	26	-	730-750
800 mm	P8FHSP80	-	-	-	-	26	-	770-790
900 mm	P8FHSP90	-	-	-	-	26	-	870-890
1000 mm	P8FHSP100	-	-	-	-	26	-	970-990
1200 mm	P8FHSP120	-	-	-	-	26	-	1170-1190

\*\*\* When ordering matt black add **MBK** and brushed brass please add **BRG** to the product codes

**Note:** Doesn't apply to side panels.

**Optional Items**

Product	***Product Code
**Retro Fit Handle	P8RH
† 10mm Extension Post	P8SOS

\*\*An optional handle is available if required.

The handle can be retro fitted and only needs to be purchased if preferred.

† All doors and side panels can be extended in 10mm increments with an extension post (to a maximum of 20mm/ 2 posts per fixed panel side only)

\*\*\* When ordering matt black add **MBK** and brushed brass please add **BRG** to the product codes

SHOWROOM COLLECTION

## pinnacle8

level access hinged recess doors

The pinnacle8 level access hinged door is available in sizes ranging from 800mm to 1200mm. Stylish rise and fall hinges, minimalist frameless design with crystal clear seals, pinnacle8 will enhance any bathroom design.

Level access left hand brushed brass hinged recess enclosure



**Features**

- + 8mm toughened safety glass
- + 2000mm high
- + Level access
- + Slimline profile with 20mm wall adjustment
- + Lifeshield™ Glass Protection
- + Crystal clear glass to glass seals
- + Die cast rise and fall hinges
- + Frameless side panels
- + Optional retro fit handle
- + Available in chrome, matt black and brushed brass
- + Lifetime Guarantee
- + Made in Britain

**Layout**

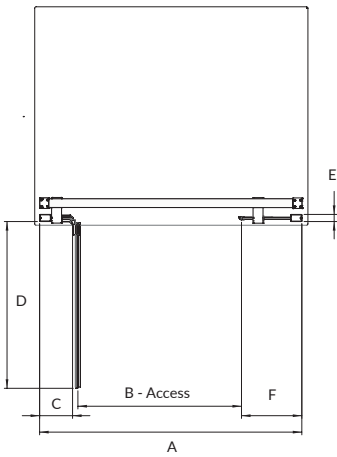

Hinged recess doors are supplied left hand or right hand



Die cast rise and fall hinge

**Codes & Dimensions**

Door Size	***Product Code	Dimensions (mm)						
		A	B	C	D	E	F	G
800mm	P8FH80L	760-800	500	120-140	509	26	125	
800mm	P8FH80R	760-800	500	120-140	509	26	125	
900mm	P8FH90L	860-900	600	120-140	609	26	125	
900mm	P8FH90R	860-900	600	120-140	609	26	125	
1000mm	P8FH100L	960-1000	600	120-140	609	26	225	
1000mm	P8FH100R	960-1000	600	120-140	609	26	225	
1100mm	P8FH110L	1060-1100	600	120-140	609	26	325	
1100mm	P8FH110R	1060-1100	600	120-140	609	26	325	
1200mm	P8FH120L	1160-1200	600	120-140	609	26	425	
1200mm	P8FH120R	1160-1200	600	120-140	609	26	425	

\*\*\* When ordering matt black add **MBK** and brushed brass please add **BRG** to the product codes

**Optional Items**

Product	***Product Code
**Retro Fit Handle	P8RH
† 10mm Extension Post	P8SOS

\*\*An optional handle is available if required.

The handle can be retro fitted and only needs to be purchased if preferred.

† All doors and side panels can be extended in 10mm increments with an extension post (to a maximum of 20mm/ 2 posts per fixed panel side only)

SHOWROOM COLLECTION

# pinnacle8

straight sliding corner doors

---

Available in chrome, matt black and brushed brass the pinnacle8 sliding corner door is available in sizes ranging from 1000mm - 1800mm. Perfect for the medium to large showering space. Semi-frameless with crystal clear seals these minimalist doors give an illusion of endless space.

1200mm corner straight sliding door



**Features**

- + 8mm toughened safety glass
- + 2000mm high
- + Concealed fixings
- + Slimline profile with 20mm wall adjustment
- + Lifeshield™ Glass Protection
- + Crystal clear glass to glass seals
- + Twin Rollers with stainless steel bearings
- + Available in chrome, matt black and brushed brass
- + Lifetime Guarantee
- + Made in Britain

**Layout**

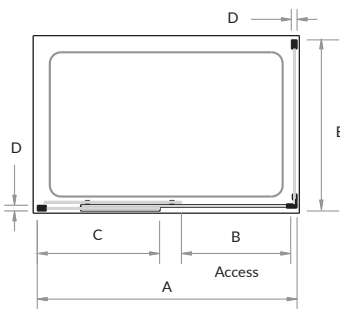

Straight sliding recess doors can be fitted to open either to the left or right by rotating the enclosure 180°

In a corner situation the door always closes to the side panel.



Minimalist finger pull

**Codes & Dimensions §**

Door Size	***Product Code	Dimensions (mm)				
		A	B	C	D	E
1000mm	P8SC100	970-990	400	452-472	26	-
1100mm	P8SC110	1070-1090	400	552-572	26	-
1200mm	P8SC120	1170-1190	500	552-572	26	-
1400mm	P8SC140	1370-1390	600	652-672	26	-
1500mm	P8SC150	1470-1490	600	752-772	26	-
1600mm	P8SC160	1570-1590	600	852-872	26	-
1700mm	P8SC170	1670-1690	600	952-972	26	-
1800mm	P8SC180	1770-1790	600	1052-1072	26	-

**Side Panels**

700mm	P8SC2SP70	-	-	-	26	670-690
760mm	P8SC2SP76	-	-	-	26	730-750
800mm	P8SC2SP80	-	-	-	26	770-790
900mm	P8SC2SP90	-	-	-	26	870-890
1000mm	P8SC2SP100	-	-	-	26	970-990
1200mm	P8SC2SP120	-	-	-	26	1170-1190

\*\*\* When ordering matt black add **MBK** and brushed brass please add **BRG** to the product codes

**Optional Items**

Product	Product Code
*Angled Stabilising Bracket for Doors (1000 & 1100mm)	P8SB22
*Angled Stabilising Bracket for Doors 1200mm+	P8SB32
**Retro Fit Handle	P8RH
† 10mm Extension Post	P8SOS

\* An optional angled stabilising bracket is available for larger doors if additional stability is required.

\*\*An optional handle is available if required.

Both angled bracket and handle can be retro fitted and only need to be purchased if preferred.

† All doors and side panels can be extended in 10mm increments with an extension post (to a maximum of 20mm/ 2 posts per fixed panel side only)

SHOWROOM COLLECTION

# pinnacle8

straight sliding recess doors

---

Available in chrome, matt black and brushed brass finishes, the pinnacle8 sliding recess door is available in sizes ranging from 1000mm - 1800mm, perfect for the medium to large showering space. Featuring crystal clear seals, these minimalist doors give an illusion of endless space.

1200mm recess straight sliding door



**Features**

- + 8mm toughened safety glass
- + 2000mm high
- + Concealed fixings
- + Slimline profile with 20mm wall adjustment
- + Lifeshield™ Glass Protection
- + Crystal clear glass to glass seals
- + Twin Rollers with stainless steel bearings
- + Available in chrome, matt black and brushed brass
- + Lifetime Guarantee
- + Made in Britain

**Layout**

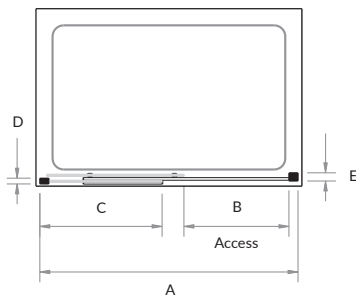

Straight sliding corner doors can be fitted to open either to the left or right by rotating the enclosure 180°



Door twin rollers

**Codes & Dimensions §**

Door Size	***Product Code	Dimensions (mm)				
		A	B	C	D	E
1000mm	P8SR100	965-1005	375-395	452-472	26	37
1100mm	P8SR110	1065-1105	375-395	552-572	26	37
1200mm	P8SR120	1165-1205	475-495	552-572	26	37
1400mm	P8SR140	1365-1405	575-595	652-672	26	37
1500mm	P8SR150	1465-1505	575-595	752-772	26	37
1600mm	P8SR160	1565-1605	575-595	852-872	26	37
1700mm	P8SR170	1665-1705	575-595	952-972	26	37
1800mm	P8SR180	1765-1805	575-595	1052-1072	26	37

\*\*\* When ordering matt black add **MBK** and brushed brass please add **BRG** to the product codes

§ **N.B** Sliding doors for Recess and Corner are not interchangeable

**Optional Items**

Product	Product Code
*Angled Stabilising Bracket for Doors (1000 & 1100mm)	P8SB22
*Angled Stabilising Bracket for Doors 1200mm+	P8SB32
**Retro Fit Handle	P8RH
† 10mm Extension Post	P8SOS

\* An optional angled stabilising bracket is available for larger doors if additional stability is required.

\*\*An optional handle is available if required.

Both angled bracket and handle can be retro fitted and only need to be purchased if preferred.

† All doors and side panels can be extended in 10mm increments with an extension post (to a maximum of 20mm/ 2 posts per fixed panel side only)

SHOWROOM COLLECTION

# pinnacle8

level access straight sliding corner doors

---

Featuring chrome, matt black and brushed brass finishes, the pinnacle8 level access sliding door can be used to create corner, recess and 3 sided enclosures. This level access door is available in sizes ranging from 1200mm - 1500mm, perfect for the medium to large showering space.

Chrome 1200mm right handed corner sliding door



**Features**

- + 8mm toughened safety glass
- + 2000mm high
- + Concealed fixings
- + Level access
- + Slimline profile with 20mm wall adjustment
- + Lifeshield™ Glass Protection
- + Crystal clear glass to glass seals
- + Twin Rollers with stainless steel bearings
- + Can be used to create 3 sided enclosures
- + Available in chrome, matt black and brushed brass
- + Lifetime Guarantee
- + Made in Britain

**Layout**

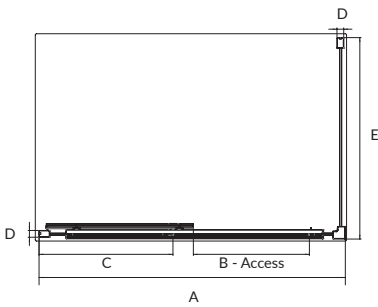

Level access sliding doors are supplied left or right handed



Crystal clear glass to glass corner seals

**Codes & Dimensions**

Door Size	***Product Code	Dimensions (mm)				
		A	B	C	D	E
1200mm	P8FS120	1180-1200	450	515	26	-
1300mm	P8FS130	1280-1300	450	615	26	-
1400mm	P8FS140	1380-1400	550	615	26	-
1500mm	P8FS150	1480-1500	550	715	26	-

Side Panels						
700mm	P8FSP70	-	-	-	26	670-690
760mm	P8FSP76	-	-	-	26	730-750
800mm	P8FSP80	-	-	-	26	770-790
900mm	P8FSP90	-	-	-	26	870-890
1000mm	P8FSP100	-	-	-	26	970-990
1200mm	P8FSP120	-	-	-	26	1170-1190

\*\*\*Please add **L or R** to the product code to indicate left or right handed door.  
 \*\*\* When ordering matt black add **MBK** and brushed brass please add **BRG** to the product codes

**Optional Items**

Product	***Product Code
**Retro Fit Handle	P8RH
*Angled Stabilising Bracket for Doors (Optional)	P8SB32
† 10mm Extension Post	P8SOS

\* Angled stabilising bracket is required for additional stability.  
 \*\*An optional handle is available if required.  
 Both angled bracket and handle can be retro fitted and only need to be purchased if preferred.  
 † All doors and side panels can be extended in 10mm increments with an extension post (to a maximum of 20mm/ 2 posts per fixed panel side only)  
 \*\*\* When ordering matt black add **MBK** and brushed brass please add **BRG** to the product codes

SHOWROOM COLLECTION

# pinnacle8

level access straight sliding recess doors

---

Featuring chrome, matt black or brushed brass finishes the pinnacle8 level access sliding door is available in sizes ranging from 1200mm - 1500mm, perfect for the medium to large showering space.

Brushed brass right hand 1200mm recess sliding door



**Features**

- + 8mm toughened safety glass
- + 2000mm high
- + Concealed fixings
- + Level access
- + Slimline profile with 20mm wall adjustment
- + Lifeshield™ Glass Protection
- + Crystal clear glass to glass seals
- + Twin Rollers with stainless steel bearings
- + Available in chrome, matt black and brushed brass
- + Lifetime Guarantee
- + Made in Britain

**Layout**

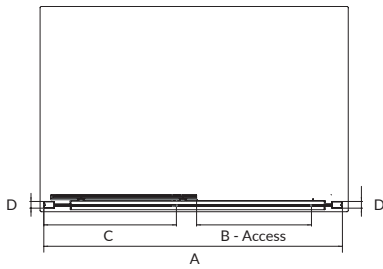

Level access sliding doors are supplied left or right handed



Brushed brass retro fit handle

**Codes & Dimensions**

Door Size	***Product Code	Dimensions (mm)			
		A	B	C	D
1200mm	P8FS120	1165-1205	450	515	26
1300mm	P8FS130	1265-1305	450	615	26
1400mm	P8FS140	1365-1405	550	615	26
1500mm	P8FS150	1465-1505	550	715	26

\*\*\*Please add **L** or **R** to the product code to indicate left or right handed door.  
When ordering matt black add **MBK** and brushed brass please add **BRG** to the product codes

**Optional Items**

Product	***Product Code
**Retro Fit Handle	P8RH
*Angled Stabilising Bracket for Doors (Optional)	P8SB32
† 10mm Extension Post	P8SOS

\* Angled stabilising bracket is required for additional stability.

\*\*An optional handle is available if required.

Both angled bracket and handle can be retro fitted and only need to be purchased if preferred.

† All doors and side panels can be extended in 10mm increments with an extension post (to a maximum of 20mm/ 2 posts per fixed panel side only)

\*\*\* When ordering matt black add **MBK** and brushed brass please add **BRG** to the product codes

SHOWROOM COLLECTION

# pinnacle8

## Level Access Pentangle Enclosure

---

The pinnacle8 level access pentangle and off-set pentangle offer a stylish alternative to the more traditional quadrant and off-set quadrant enclosures.

The hinged door and level access combined make this the perfect enclosure for multi-generational households.

Matt black 900 x 900mm pinnacle8 pentangle enclosure.



**Features & Benefits**

- + 8mm toughened safety glass
- + 2000mm high
- + Available in chrome, matt black and brushed brass finishes
- + Features stylish die cast rise and fall hinges
- + Concealed fixings throughout
- + Available in 4 sizes
- + Slimline profile with 20mm adjustment
- + Crystal clear glass to glass seals
- + Lifeshield glass protection
- + Lifetime Guarantee
- + Made in Britain

**Layout**

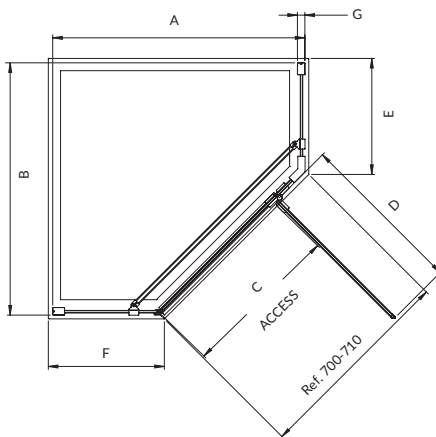

Chrome stabilising bar

**Codes & Dimensions**

Door Size	*Product Code	Adjustments (mm)		Dimensions (mm)				
		A	B	C	D	E	F	G
900 x 900mm	P8FP90 L/R	872-885	872-885	550	575	400	400	26
1000 x 1000mm (LH)	P8FP100L	972-985	972-985	550	575	500	500	26
1000 x 1000mm (RH)	P8FP100R	972-985	972-985	550	575	500	500	26
1200 x 900mm (LH)	P8FP12090L	1172-1185	872-885	550	575	400	700	26
1200 x 900mm (RH)	P8FP12090R	1172-1185	872-885	550	575	400	700	26
1400 x 900mm(LH)	P8FP14090L	1372-1385	872-885	550	575	400	900	26
1400 x 900mm (RH)	P8FP14090R	1372-1385	872-885	550	575	400	900	26

**Door Height:** 2000 mm excluding tray

\*When ordering matt black add **MBK** and brushed brass please add **BRG** to the product codes

**Optional Items**

Product	***Product Code
**Retro Fit Handle	P8RH
† 10mm Extension Post	P8SOS

\*\*An optional handle is available if required.

† All doors and side panels can be extended in 10mm increments with an extension post (to a maximum of 20mm/ 2 posts per fixed panel side only)

\*\*\* When ordering matt black add **MBK** and brushed brass please add **BRG** to the product codes



Brushed brass 1200 x 900mm pinnacle8 pentangle enclosure.

SHOWROOM COLLECTION

# pinnacle8

quadrant doors

---

Surround yourself with a panoramic seamless expanse of glass.

The semi-frameless pinnacle8 Quadrant and Offset Quadrant features uninterrupted glass from wall to wall with its crystal clear seals and unique finger pull.

1200mm x 900mm right hand offset quadrant enclosure



**Features**

- + 8mm toughened safety glass
- + 2000mm high
- + Concealed fixings
- + Slimline profile with 20mm wall adjustment
- + Lifeshield™ Glass Protection
- + Crystal clear glass to glass seals
- + Twin Rollers with stainless steel bearings and dynamic adjustment
- + Semi-frameless panels
- + Die cast bottom guides
- + Available in chrome, matt black and brushed brass
- + Lifetime Guarantee
- + Made in Britain

**Offset Quad Layout**

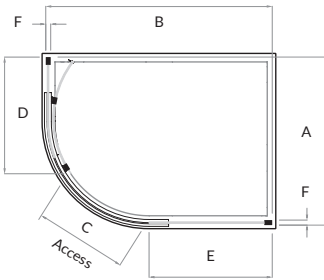

**Quad Layout**

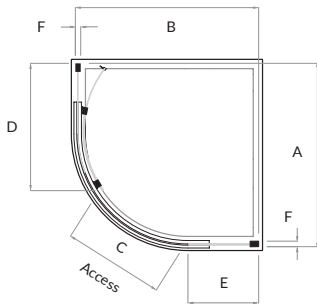

Quadrant doors can be fitted either to open to the left or right



Scan the QR code to view the quadrant handing diagrams

**Codes & Dimensions**

Door Size	***Product Code	Adjustments (mm)		Dimensions (mm)			
		A	B	C	D	E	F
900 x 900mm	P8Q90	865-885	865-885	470	600-620	335-355	26
1000 x 1000mm	P8Q100	965-985	965-985	470	700-720	435-455	26
900 x 800mm	P8Q9080	865-885	765-785	470	600-620	235-255	26
1000 x 800mm	P8Q1080	965-985	765-785	470	700-720	235-255	26
1000 x 900mm	P8Q1090	965-985	865-885	470	600-620	435-455	26
1200 x 800mm	P8Q1280	765-785	1165-1185	470	900-920	235-255	26
1200 x 900mm	P8Q129	865-885	1165-1185	470	600-620	635-655	26

\*\*\* When ordering matt black add **MBK** and brushed brass please add **BRG** to the product codes

**Optional Items**

Product	Product Code
*Angled Stabilising Bracket for Doors (1000 & 1100mm)	P8SB22
*Angled Stabilising Bracket for Doors 1200mm+	P8SB32
**Retro Fit Handle	P8RH
† 10mm Extension Post	P8SOS

\* An optional angled stabilising bracket is available for larger doors if additional stability is required.

\*\*An optional handle is available if required.

Both angled bracket and handle can be retro fitted and only need to be purchased if preferred.

† All doors and side panels can be extended in 10mm increments with an extension post (to a maximum of 20mm/ 2 posts per fixed panel side only)

**Shower Tray Handing & Door Opening Direction Guide**

Tray Sizes	Tray Handing		Opening Directions		Unhanded
	RH	LH	RH	LH	
900 x 900mm	-	-	-	-	✓
1000 x 1000mm	-	-	-	-	✓
900 x 800mm	-	✓	-	✓	-
900 x 800mm	✓	-	✓	-	-
1000 x 800mm	-	✓	-	✓	-
1000 x 800mm	✓	-	✓	-	-
1000 x 900mm	-	✓	✓	-	-
1000 x 900mm	✓	-	-	✓	-
1200 x 800mm	-	✓	-	✓	-
1200 x 800mm	✓	-	✓	-	-
1200 x 900mm	-	✓	✓	-	-
1200 x 900mm	✓	-	-	✓	-

SHOWROOM COLLECTION

# pinnacle8

level access quadrant doors

---

The pinnacle8 level access hinged quadrant and offset quadrant doors are simply stunning and will enhance any bathroom. Featuring stylish rise and fall hinges, these enclosures offer the perfect solution to those looking to future proof their bathroom space.

Level access quad on an connect2 shower tray.



**Features**

- + 8mm toughened safety glass
- + 2000mm high
- + Concealed fixings
- + Level access
- + Slimline profile with 20mm wall adjustment
- + Lifeshield™ Glass Protection
- + Crystal clear glass to glass seals
- + Die cast rise and fall hinges
- + Available in chrome, matt black and brushed brass
- + Lifetime Guarantee
- + Made in Britain

**Layout**

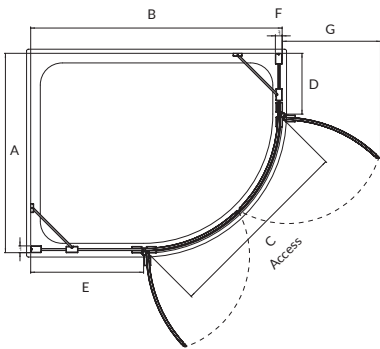

Matt black level access quad hinged doors open.

**Codes & Dimensions §**

Door Size	***Product Code	Adjustments (mm)		Dimensions (mm)				
		A	B	C	D	E	F	G
900 x 900mm	P8FHQ90	865-885	865-885	730	333	333	26	375
1000 x 1000mm	P8FHQ100	965-985	965-985	730	433	433	26	375
900 x 800mm (LH)	P8FHQ9080L	865-885	765-785	730	233	233	26	375
900 x 800mm (RH)	P8FHQ9080R	765-785	865-885	730	233	333	26	375
1000 x 800mm (LH)	P8FHQ1080L	965-985	765-785	730	333	233	26	375
1000 x 800mm (RH)	P8FHQ1080R	765-785	965-985	730	433	233	26	375
1000 x 900mm (LH)	P8FHQ1090L	965-985	865-885	730	233	433	26	375
1000 x 900mm (RH)	P8FHQ1090R	865-885	965-985	730	333	433	26	375
1200 x 800mm (LH)	P8FHQ1280L	1165-1185	765-785	730	633	233	26	375
1200 x 800mm (RH)	P8FHQ1280R	765-785	1165-1185	730	233	633	26	375
1200 x 900mm (LH)	P8FHQ1290L	1165-1185	865-885	730	633	333	26	375
1200 x 900mm (RH)	P8FHQ1290R	865-885	1165-1185	730	333	633	26	375

\*\*\* When ordering matt black add **MBK** and brushed brass please add **BRG** to the product codes

**Optional Items**

Product	***Product Code
**Retro Fit Handle	P8RH
† 10mm Extension Post	P8SOS

\*\*An optional handle is available if required.

† All doors and side panels can be extended in 10mm increments with an extension post (to a maximum of 20mm/ 2 posts per fixed panel side only)

\*\*\* When ordering matt black add **MBK** and brushed brass please add **BRG** to the product codes



Brushed brass left hand level access offset quad.

SHOWROOM COLLECTION

pinnacle**8**

centre folding doors

The space saving centre-folding door, available in sizes ranging from 800mm to 1000mm, is just perfect for the small to medium showering space. With a hidden door mechanism, concealed magnets and crystal clear seals you have an uninterrupted glass door with a positive closing action.

Corner centre folding enclosure



**Features**

- + 8mm toughened safety glass
- + 2000mm high
- + Concealed fixings
- + Slimline profile with 20mm wall adjustment
- + Lifeshield™ Glass Protection
- + Crystal clear glass to glass seals
- + Twin Rollers with stainless steel bearings
- + Crystal clear corner seals
- + Lifetime Guarantee
- + Made in Britain

**Layout**

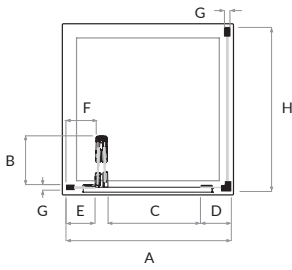

All doors suitable for corner or recess fixing



Concealed folding mechanism.

**Codes & Dimensions**

Door Size	Product Code	Adjustments (mm)		Dimensions (mm)					
		*RECESS	*CORNER	B	C	D	E	F	G
		A	A						
800mm	P8CF80	765-805	770-790	230	440	145	140	140	26
900mm	P8CF90	865-905	870-890	255	490	170	175	160	26
1000mm	P8CF100	965-1005	970-990	305	590	170	175	160	26

\*Recess Measurement (Door only). \*Corner Measurement (Door + 1 Panel).

**Side Panels**

Door Size	Product Code	Product Code	
		G	H
800mm	P8CF2SP80	26	770-790
900mm	P8CF2SP90	26	870-890
1000mm	P8CF2SP100	26	970-990
1200mm	P8CF2SP120	26	1170-1190

**Optional Items**

Product	Product Code
**Retro Fit Handle	P8RHCF
† 10mm Extension Post	P8SOS

\*\*An optional handle is available if required.

† All doors and side panels can be extended in 10mm increments with an extension post (to a maximum of 20mm/ 2 posts per fixed panel side only)



1 x 800mm panel, 1 x 700mm panel, 1 x front panel fixing kit and wall, 1 x R/H fold away deflector panel and a glass to glass corner seal

SHOWROOM COLLECTION

ultimate<sup>10</sup>

## Bath screens

Based on the Kudos ultimate walk-in shower enclosure system, ultimate fixed bath screens offer a simple yet elegant solution to over-bath showering. Available in 4 panel sizes in stunning 10mm toughened safety glass with Lifeshield™ coating and a choice of fixings, you can create combinations to suit virtually all situations. Available in a number of colour finishes.

A retro-fit Foldaway deflector panel allows for smaller front panels to be fitted to give maximum access to the bath whilst ensuring that when showering the spray is contained with the bathing area.

**Features**

- + Lifetime Guarantee
- + 10mm Toughened safety glass with Lifeshield™ protection
- + Adjustment for out of true walls
- + Available in five colour finishes



*Foldaway Deflector Panel*

## SHOWROOM COLLECTION

ultimate<sup>10</sup>

## Over-bath panels

## Foldaway Deflector Panels

The ultimate over-bath foldaway deflector panel when in use helps keep water inside the bath and when not in use folds neatly behind the front panel leaving access to the bath.



## Colour Finishes

Kudos ultimate fittings are available in chrome/ silver, matt black and brushed brass, in addition Kudos ultimate fittings are available in chrome, matt black brushed brass and brushed nickel. Polished gold is to special order.

## Standard Colour Finishes



## Special Order Colour Finishes\*



\*Special order items, please allow 8 weeks

## Glass Panels

*Description	Product Code
700mm x 1600mm (10mm Glass Panel)	10BSWP700
750mm x 1600mm (10mm Glass Panel)	10BSWP750
800mm x 1600mm (10mm Glass Panel)	10BSWP800
900mm x 1600mm (10mm Glass Panel)	10BSWP900

\*Sizes shown are nominal.

All panels are undersized by 45mm to allow for tiling

## Fixings &amp; Deflector Panels

Description	Silver/Chrome Product Code	Matt Black Product Code	Brushed Brass Product Code	Brushed Nickel Product Code	Polished Gold Product Code
Wall Post	10BSBSWPK	10BSBSWPKMBK	10BSBSWPK BRG	10BSBSWPK BRN	10BSBSWPKPG
Front Panel Fixing Kit	10WPFPFK	10WPFPFKMBK	10WPFPFKBRG	10WPFPFKB RN	10WPFPFKPG
Side Panel Fixing Kit	10WPSPFK	10WPSPFKMBK	10WPSPFKBRG	10WPSPFKB RN	10WPSPFKPG
300mm Angled Fixing Kit	10WPGW30	10WPGW30MBK	10WPGW30BRG	10WPGW30BRN	10WPGW30PG
Glass to Ceiling Fixing Kit	10WPGC	10WPGCMBK	10WPGCBRG	10WPGCB RN	10WPGCPG
Glass to Glass Corner Seal	10BSWPCS	-	-	-	-
Foldaway Hinged Deflector Kit (Left Hand)*	10BSWPFADPLH	10BSWPFADPLHMBK	10BSWPFADPLHBRG	10BSWPFADPLHBRN	10BSWPFADPLHPG
Foldaway Hinged Deflector Kit (Right Hand)*	10BSWPFADPRH	10BSWPFADPRHMBK	10BSWPFADPRHBRG	10BSWPFADPRHBRN	10BSWPFADPRHPG

\* Deflectors are handed by which side the hinges are located.

## Configurations

Illustrations show some of the configurations possible with the Kudos ultimate over-bath shower panel system. Each option shows the components required, to which a foldaway deflector kit can be added.

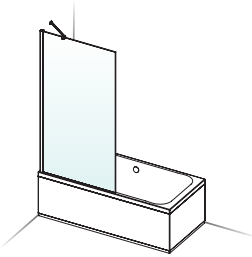

### Corner

- 1 x Glass Panel (Front)
- 1 x Glass Panel (End)
- 2 x Wall Post
- 1 x Front Panel Fixing Kit\*
- 1 x Side Panel Fixing Kit\*

*\*Standard, Ceiling or Angled*

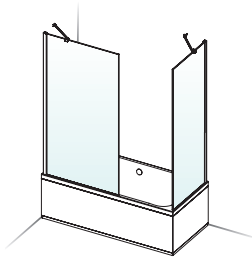

### Single Panel

- 1 x Glass Panel
- 1 x Wall Post
- 1 x Front Panel Fixing Kit\*

*\*Standard, Ceiling or Angled*

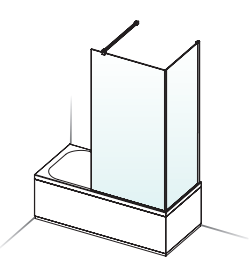

### Corner (glass to glass)

- 1 x Glass Panel (Front)
- 1 x Glass Panel (End)
- 1 x Wall Post
- 1 x Front Panel Fixing Kit\*
- 1 x Corner Seal

*\*Standard, or Ceiling*

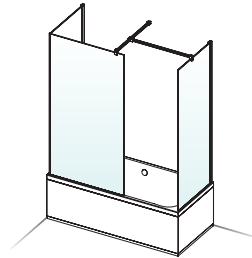

### Three Sided

- 1 x Glass Panel (Front)
- 2 x Glass Panels (End)
- 2 x Wall Posts
- 1 x Front Panel Fixing Kit\*
- 1 x Side Panel Fixing Kit\*
- 1 x Corner Seal

*\*Standard, or Ceiling*





Slate effect white ultimate tray

SHOWROOM COLLECTION

# ultimate

## shower tray collection

---

### The ultimate shower tray

Combining innovation and design, this stunning, light weight, super slim shower tray is available from stock in 2 colour finishes (slate effect white and slate effect grey), is slip and stain resistant and contains an \*antimicrobial additive to inhibit the growth of microbes.

At just 27mm high this slate effect tray is available in 19 standard sizes up to 2000mm x 900mm. Additional waste positions, colour and size options (up to 2000mm x 1000mm) are available via our Bespoke ordering service, the ultimate shower tray is a stylish alternative to a traditional shower tray or even a wet room floor.

*\*applies to slate effect finishes only*

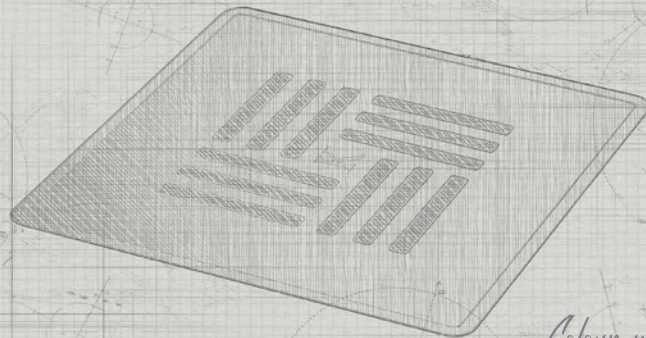

*Colour matched waste*

**SHOWROOM** COLLECTION

# ultimate

shower trays

---

Luxurious and stylish, the ultimate shower tray will make a statement in any bathroom.

Available in two stunning slate effect finishes, this ultra slim tray is both slip and stain resistant and contains an anti-microbial additive for easy cleaning.

Additional colour finishes, waste positions and sizes are available to order via our bespoke service.

Slate effect dark grey ultimate tray with matt black ultimate walk-in



**Features**

- + 27mm deep
- + Available in 19 standard sizes (up to 2000 x 900mm)
- + Slip and stain resistant
- + Trimmable
- + Up to 60% lighter than traditional shower trays
- + Available in two colour finishes as standard
- + Lifetime Guarantee
- + Additional colour finishes, waste positions and sizes available on request (max. 2000 x 1000mm)



White slate effect tray



Dark grey slate effect tray

**Standard Waste Options**



White slate with chrome waste

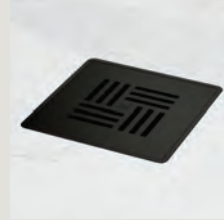

White slate with black waste



White slate with matching waste



Dark grey with chrome waste



Dark grey with black waste



Dark grey with matching waste

**Standard Waste Product Codes**

Product	Product Code
Chrome Waste (with chrome grate)	WRWALS
Black Waste (with matt black grate)	WRWALMBK
Dark Grey Waste (with dark grey grate)	WRWALS LGR
White Waste (with white grate)	WRWALWH

**Bespoke Waste Options**



Stone with matching waste



Mid grey with matching waste

All waste colour options can be used in bespoke designs.

**Bespoke Waste Product Codes**

Product	Product Code
Stone Waste (with stone grate)	WRWALSTO
Mid Grey (with mid grey grate)	WRWALMGR

## SHOWROOM COLLECTION

# ultimate

## shower trays

Should you need a size, colour or even waste position that isn't featured as part of our stocked range, we offer a bespoke service that will enable you to create the ultimate shower tray that meets your requirements.

### Product Sizes & Codes

Tray Size	White Slate Effect Product Code	Dark Grey Slate Effect Product Code
1200 x 800mm	ULT12080SWE	ULT12080SDGE
1300 x 800mm	ULT13080SWE	ULT13080SDGE
1400 x 800mm	ULT14080SWE	ULT14080SDGE
1500 x 800mm	ULT15080SWE	ULT15080SDGE
1600 x 800mm	ULT16080SWE	ULT16080SDGE
1700 x 700mm	ULT17070SWE	ULT17070SDGE
1700 x 800mm	ULT17080SWE	ULT17080SDGE
1800 x 800mm	ULT18080SWE	ULT18080SDGE
1900 x 800mm	ULT19080SWE	ULT19080SDGE
2000 x 800mm	ULT20080SWE	ULT20080SDGE
1200 x 900mm	ULT12090SWE	ULT12090SDGE
1300 x 900mm	ULT13090SWE	ULT13090SDGE
1400 x 900mm	ULT14090SWE	ULT14090SDGE
1500 x 900mm	ULT15090SWE	ULT15090SDGE
1600 x 900mm	ULT16090SWE	ULT16090SDGE
1700 x 900mm	ULT17090SWE	ULT17090SDGE
1800 x 900mm	ULT18090SWE	ULT18090SDGE
1900 x 900mm	ULT19090SWE	ULT19090SDGE
2000 x 900mm	ULT20090SWE	ULT20090SDGE

For any other size or waste position there's a simple **3 step process...**

**Step 1:** Contact your Kudos Retailer outlining your specific requirements (including colour, waste position and dimensions).

**Step 2:** Your Kudos Retailer will receive a quote and estimated delivery window (from receipt of the confirmed order).

**Step 3:** Once your shower tray is ready we will arrange for delivery to your Kudos Retailer.

### Standard Finishes



White Slate Effect

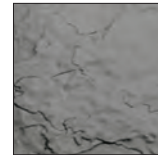

Dark Grey Slate Effect

### Bespoke Finishes



Mid Grey Slate Effect

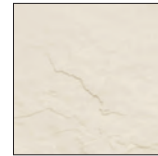

Stone Slate Effect



White (Slip Resistant)



Grey (Slip Resistant)



Slate effect white ultimate tray



SHOWROOM COLLECTION

# bespoke

showering solutions

---

Established for over 25 years, Kudos Showers is recognised in the industry for the quality, design and workmanship associated with their extensive product range.

From showers to bathscreens, enclosures to wet-room systems, everything is designed in-house by a team of people with keen attention to detail – ensuring that every Kudos product is built to the same exacting standards.

Kudos Showers also recognise that sometimes products from their core ranges don't meet the customer's requirements – that could be because they're working with an unusual sized space, or have a very specific 'look' in mind. On these occasions, the Bespoke by Kudos range and service really comes into its own.

The 'Bespoke by Kudos' team will work with you to create the shower enclosure that best meets your needs.

Our bespoke design team  
can produce showering solutions  
that are tailor-made to  
your requirements.



*Retro fit handle*

## SHOWROOM COLLECTION

# Why choose 'Bespoke By Kudos' for your tailormade solution

Quite simply put, Kudos offer the best in market Bespoke solution, we will work with you from measuring\* the space you have available to design specification and quote, right the way through to installation\*\*, all the while ensuring that your specific needs are at the forefront of what we do.

Every Bespoke enclosure is manufactured and hand-finished by our in-house team, ensuring that each enclosure is given the same level of care and attention.

We offer a 'measure only\*' or 'measure and install\*\*' service, designed to give you additional peace of mind. One of our Support Team will visit and measure the space that has been allocated for your enclosure and, if you wish, will also install the enclosure for you once it's ready.

\* This is a separate chargeable service.

\*\* Installation only available where a Kudos representative has measured the enclosure.

## Glass Colour Options †



Satin Frosted



Bronze Tint



Smoke Grey

† Despite every effort to provide accurate images of each product's colour and design, actual colours and design may vary slightly.

Coloured glass options cannot be used to create quadrant enclosures

## Available Colour Finishes ††



Chrome



Matt Black



Brushed Brass



Brushed Nickel



Polished Gold



Brushed Gun Metal



Brushed Copper



White

†† Colour Finish options may vary according to selected range.

## How to order...

Ordering from our Bespoke team couldn't be simpler, just 5 steps to your perfect showering solution:

- 1 Contact your Kudos Retailer who will send us a rough drawing of what you're trying to achieve and/ or the space that you have available. We will confirm if we are able to accommodate your request and will provide you with a guide price.
- 2 If you wish to proceed you will need to provide the following an accurate drawing of the space that is available, alternatively this is the point at which you can opt to use our measuring service.
- 3 Once final measurements have been received we will provide a detailed drawing, final price and an estimated delivery date.
- 4 Once you sign the drawings off a deposit will be required before we move to step 5
- 5 Once your product is ready we will arrange for delivery and (if you have opted for the measure and fit service) arrange a date for our Support Team colleague to install your enclosure.



**RONAL Bathrooms UK Ltd**

Elmsfield Park, Holme  
Cumbria LA6 1RJ  
United Kingdom

Telephone: +44 (0)1539 564040

Email: [sales@kudosshowers.co.uk](mailto:sales@kudosshowers.co.uk)

---

[www.kudosshowers.co.uk](http://www.kudosshowers.co.uk)