

# FITTED FURNITURE

RETAIL PRICES

*IN £ INCLUDING VAT  
MAY 2025*

**Ab**  
ambiance bain



# RETAIL PRICES IN £ INCLUDING VAT

<b>WC UNITS</b>	PAGE <b>002</b>
<b>BIDET UNITS</b>	PAGE <b>004</b>
<b>BASIN UNITS</b>	PAGE <b>005</b>
<b>BASE UNITS</b>	PAGE <b>008</b>
<b>HI-LINE UNITS</b>	PAGE <b>012</b>
<b>50CM DEEP UNITS</b>	PAGE <b>016</b>
<b>60CM DEEP UNITS</b>	PAGE <b>017</b>
<b>TALL UNITS</b>	PAGE <b>018</b>
<b>HI-LINE TALL UNITS</b>	PAGE <b>019</b>
<b>WALL UNITS</b>	PAGE <b>020</b>
<b>PANORAMIC MIRRORS &amp; WALL SHELVING PANELS</b>	PAGE <b>022</b>
<b>LIGHT PELMETS</b>	PAGE <b>023</b>
<b>SMO™ WORKTOPS</b>	PAGE <b>024</b>
<b>SOLID SURFACE WORKTOPS</b>	PAGE <b>028</b>
<b>BATH PANELS</b>	PAGE <b>029</b>
<b>MIRRORS &amp; LIGHTS</b>	PAGE <b>030</b>
<b>SPARE FASCIAS</b>	PAGE <b>032</b>
<b>ANCILLARY ITEMS</b>	PAGE <b>036</b>
<b>TECHNICAL INFORMATION</b>	PAGE <b>038</b>
<b>HANDLES &amp; FINISHES</b>	PAGE <b>040</b>

**SMO™**

PRICES QUOTED ARE RRP INCLUDING VAT.

FOR THE PURPOSE OF CONTINUAL IMPROVEMENT, AMBIANCE BAIN RESERVES THE RIGHT TO MODIFY THE CHARACTERISTICS OF OUR PRODUCTS AT ANY TIME WITHOUT PRIOR NOTICE.  
COLOURS AND IMAGES ARE WITHIN THE CONSTRAINTS OF THE PRINTING PROCESS AND SHOULD NOT BE RELIED UPON FOR MATCHING PURPOSES.  
E&OE



TO VIEW OUR TERMS  
AND CONDITIONS  
VISIT OUR WEBSITE  
[WWW.AMBIANCEBAIN.CO.UK](http://WWW.AMBIANCEBAIN.CO.UK)

**AMBIANCE BAIN SALES : 01925 852675**  
**SALES@AMBIANCEBAIN.COM**

# FITTED FURNITURE

The fitted furniture range from Ambiance Bain is the most comprehensive on the market, featuring a wide collection of units and sizes allowing you to create unique bathrooms. Please take care to order the correct units for your client as all units are made to order and once confirmed no order may be changed, cancelled or amended in any way, under any circumstances.

All fitted units are priced including the necessary handles, plinth and worktop (without upstand).

Units are priced in three groups, by door style, as listed below.

All colours within each group are the same price

## MODULAR FURNITURE

Pricing for our Modular, Komplements and Shower Spaces ranges can be found within their own relevant retail brochures.

### MELAMINE DOOR STYLE



**NATIVE**  
Price Group 0  
Square edged

### FOIL DOOR STYLE



**KARLA**  
Price Group 1  
Square edged



**PROVENCE**  
Price Group 2  
Country Shaker Style

### LAMINATE DOOR STYLE



**LAGOON**  
Price Group 1  
Square edged

**Unit Dimensions shown are for the carcass size and do not include the fascia.**

# WC UNITS

## ALL PRICES INCLUDE

- HANDLES
- LAMINATE/FOIL WORKTOP WITHOUT UPSTAND
- PLINTH AND LEGS (WHEN REQUESTED)

### WC UNIT

including ■ **GEBERIT** cistern

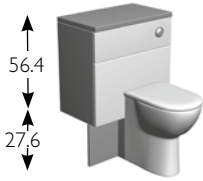

\* 40cm with ■ **Macdee** cistern.

❗ Not suitable for comfort height WC pans

Depth (cm)	Code	Width (cm)	Price Group 0	Price Group 1	Price Group 2
33	<b>WC3340*</b>	40	£923	£963	£1 079
	<b>WC3350</b>	50	£986	£1 051	£1 179
	<b>WC3360</b>	60	£1 016	£1 055	£1 191
	<b>WC3370</b>	70	£1 109	£1 160	£1 218
	<b>WC3380</b>	80	£1 160	£1 214	£1 295
20	<b>WC2040*</b>	40	£923	£963	£1 079
	<b>WC2050</b>	50	£986	£1 051	£1 179
	<b>WC2060</b>	60	£1 016	£1 055	£1 191
	<b>WC2070</b>	70	£1 109	£1 160	£1 218
	<b>WC2080</b>	80	£1 160	£1 214	£1 295

### FLOOR MOUNTED WC UNIT

including ■ **GEBERIT** cistern and colour matched side(s) where applicable.



\* 40cm with ■ **Macdee** cistern.

❗ Not suitable for comfort height WC pans

Depth (cm)	Code	Width (cm)	Price Group 0	Price Group 1	Price Group 2
33	<b>WCFL3340*</b>	40	£923	£963	£1 079
	<b>WCFL3350</b>	50	£986	£1 051	£1 179
	<b>WCFL3360</b>	60	£1 016	£1 055	£1 191
	<b>WCFL3370</b>	70	£1 109	£1 160	£1 218
	<b>WCFL3380</b>	80	£1 160	£1 214	£1 295
20	<b>WCFL2040*</b>	40	£923	£963	£1 079
	<b>WCFL2050</b>	50	£986	£1 051	£1 179
	<b>WCFL2060</b>	60	£1 016	£1 055	£1 191
	<b>WCFL2070</b>	70	£1 109	£1 160	£1 218
	<b>WCFL2080</b>	80	£1 160	£1 214	£1 295

### WALL HUNG WC UNIT

including ■ **GEBERIT** fixing frame and cistern and colour matched side(s) where applicable.



Depth (cm)	Code	Width (cm)	Price Group 0	Price Group 1	Price Group 2
33	<b>WCWH3350</b>	50	£1 400	£1 469	£1 586
	<b>WCWH3360</b>	60	£1 400	£1 469	£1 586
	<b>WCWH3370</b>	70	£1 435	£1 497	£1 602
	<b>WCWH3380</b>	80	£1 469	£1 551	£1 690
20	<b>WCWH2050</b>	50	£1 400	£1 469	£1 586
	<b>WCWH2060</b>	60	£1 400	£1 469	£1 586
	<b>WCWH2070</b>	70	£1 435	£1 497	£1 602
	<b>WCWH2080</b>	80	£1 469	£1 551	£1 690

### FULL FASCIA WC UNIT

for use with flush plate cistern types. No cistern or wall frame supplied.

❗ Colour matched side(s) where applicable.

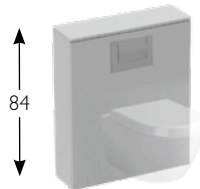

33	<b>FFWCFL3360</b>	60	£714	£765	£900
	<b>FFWCFL3370</b>	70	£796	£865	£916
	<b>FFWCFL3380</b>	80	£848	£918	£954
20	<b>FFWCFL2060</b>	60	£714	£765	£900
	<b>FFWCFL2070</b>	70	£796	£865	£916
	<b>FFWCFL2080</b>	80	£848	£918	£954

#### UPSTAND ON WORKTOP

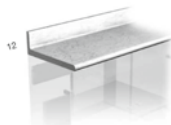

##### FACREM

£19 per 10cm  
N/A around a corner

#### CUT BACK IN DEPTH OF WORKTOP

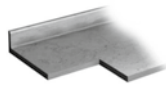

##### DECPROF

Whole worktop will be square edged  
£195

#### WORKTOP JOINT



##### JOINT

Factory prepared butt & scribe  
£130

#### STRAIGHT FILLER

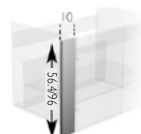

##### EFILL56/96D

Includes extra laminate worktop and plinth  
£89 / £99

#### STRAIGHT TALL FILLER



##### EFILL201D

Includes extra plinth  
£119

#### CORNER FILLER



##### EFILL56A

Includes extra laminate worktop and plinth  
£199

#### COLOUR-MATCHED SIDE



To visible side of unit  
£99 per side  
£199 for tall unit



# TALL WC UNITS

## ALL PRICES INCLUDE

- HANDLES
- LAMINATE/FOIL WORKTOP WITHOUT UPSTAND
- PLINTH AND LEGS (WHEN REQUESTED)

### TALL WC UNIT

including ■ **GEBERIT** cistern

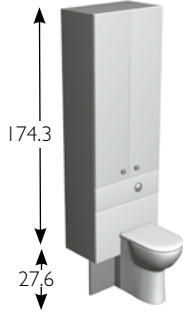

Depth (cm)	Code	Width (cm)	Price Group 0	Price Group 1	Price Group 2
33	<b>AWC3360</b>	60	£1 690	£1 799	£1 962
	<b>AWC3370</b>	70	£1 718	£1 841	£2 004
	<b>AWC3380</b>	80	£1 788	£1 911	£2 097
20	<b>AWC2060</b>	60	£1 690	£1 799	£1 962
	<b>AWC2070</b>	70	£1 718	£1 841	£2 004
	<b>AWC2080</b>	80	£1 788	£1 911	£2 097

❗ Not suitable for comfort height WC pans

### FLOOR MOUNTED TALL WC UNIT

including ■ **GEBERIT** cistern



Depth (cm)	Code	Width (cm)	Price Group 0	Price Group 1	Price Group 2
33	<b>AWCFL3360</b>	60	£1 690	£1 799	£1 962
	<b>AWCFL3370</b>	70	£1 718	£1 841	£2 004
	<b>AWCFL3380</b>	80	£1 788	£1 911	£2 097
20	<b>AWCFL2060</b>	60	£1 690	£1 799	£1 962
	<b>AWCFL2070</b>	70	£1 718	£1 841	£2 004
	<b>AWCFL2080</b>	80	£1 788	£1 911	£2 097

❗ Not suitable for comfort height WC pans

### WALL HUNG TALL WC UNIT

including ■ **GEBERIT** fixing frame and cistern



Depth (cm)	Code	Width (cm)	Price Group 0	Price Group 1	Price Group 2
33	<b>AWCWH3360</b>	60	£1 962	£2 027	£2 194
	<b>AWCWH3370</b>	70	£1 985	£2 055	£2 217
	<b>AWCWH3380</b>	80	£2 015	£2 097	£2 252
20	<b>AWCWH2060</b>	60	£1 962	£2 027	£2 194
	<b>AWCWH2070</b>	70	£1 985	£2 055	£2 217
	<b>AWCWH2080</b>	80	£2 015	£2 097	£2 252

### FULL FASCIA TALL WC UNIT

for use with flush plate cistern types.  
No cistern or wall frame.

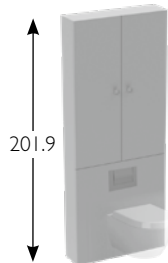

33	<b>AFFWCFL3360</b>	60	£1 388	£1 501	£1 660
	<b>AFFWCFL3370</b>	70	£1 416	£1 543	£1 703
	<b>AFFWCFL3380</b>	80	£1 484	£1 611	£1 792
20	<b>AFFWCFL2060</b>	60	£1 388	£1 501	£1 660
	<b>AFFWCFL2070</b>	70	£1 416	£1 543	£1 703
	<b>AFFWCFL2080</b>	80	£1 484	£1 611	£1 792

#### PLAIN END PANEL

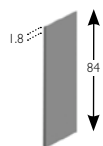

**CLAD22/3584**

Includes extra laminate worktop (20 deep shown) £ 249  
£ 129

#### PLAIN TALL END PANEL

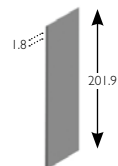

**CLAD22/35201**

(20 deep shown) £ 249  
£ 129

#### PROVENCE END PANEL

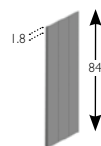

**EPANELPROV20/33**

Includes extra laminate worktop (20 deep shown) £ 285  
£ 145

#### PROVENCE TALL END PANEL

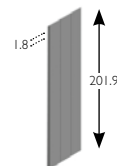

**EPANELPROVA20/33**

(20 deep shown) £ 285

#### CURVED END PANEL

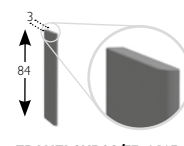

**EPANELCUR20/33** £ 145

Includes extra laminate worktop with 14/19mm overhang and rounded end. Add **ZDECCUR** at £ 195 when used with SMO™ worktop

#### CURVED TALL END PANEL

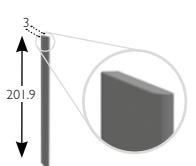

**EPANELACUR20/33** £ 285

# BIDET UNITS

## ALL PRICES INCLUDE

- HANDLES
- LAMINATE/FOIL WORKTOP WITHOUT UPSTAND
- PLINTH AND LEGS (WHEN REQUESTED)

### BIDET UNIT

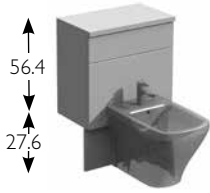

Depth (cm)	Code	Width (cm)	Price Group 0	Price Group 1	Price Group 2
33	<b>BBI3350</b>	50	£696	£742	£882
	<b>BBI3360</b>	60	£714	£765	£900
	<b>BBI3370</b>	70	£796	£865	£916
20	<b>BBI2050</b>	50	£696	£742	£882
	<b>BBI2060</b>	60	£714	£765	£900
	<b>BBI2070</b>	70	£796	£865	£916

### FLOOR MOUNTED BIDET UNIT

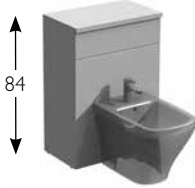

Also suitable for use with **■ GEBERIT** wall hung bidet frame (NOT INCLUDED)  
Includes colour matched side(s) where applicable.

Depth (cm)	Code	Width (cm)	Price Group 0	Price Group 1	Price Group 2
33	<b>BBIFL3350</b>	50	£696	£742	£882
	<b>BBIFL3360</b>	60	£714	£765	£900
	<b>BBIFL3370</b>	70	£796	£865	£916
20	<b>BBIFL2050</b>	50	£696	£742	£882
	<b>BBIFL2060</b>	60	£714	£765	£900
	<b>BBIFL2070</b>	70	£796	£865	£916

### TALL BIDET UNIT

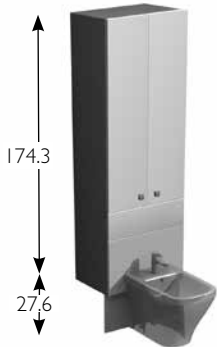

Depth (cm)	Code	Width (cm)	Price Group 0	Price Group 1	Price Group 2
33	<b>ABBI3360</b>	60	£1 388	£1 501	£1 660
	<b>ABBI3370</b>	70	£1 416	£1 543	£1 703
	<b>ABBI3380</b>	80	£1 484	£1 611	£1 792
20	<b>ABBI2060</b>	60	£1 388	£1 501	£1 660
	<b>ABBI2070</b>	70	£1 416	£1 543	£1 703
	<b>ABBI2080</b>	80	£1 484	£1 611	£1 792

### FLOOR MOUNTED TALL BIDET UNIT



Depth (cm)	Code	Width (cm)	Price Group 0	Price Group 1	Price Group 2
33	<b>ABBIFL3360</b>	60	£1 388	£1 501	£1 660
	<b>ABBIFL3370</b>	70	£1 416	£1 543	£1 703
	<b>ABBIFL3380</b>	80	£1 484	£1 611	£1 792
20	<b>ABBIFL2060</b>	60	£1 388	£1 501	£1 660
	<b>ABBIFL2070</b>	70	£1 416	£1 543	£1 703
	<b>ABBIFL2080</b>	80	£1 484	£1 611	£1 792

#### UPSTAND ON WORKTOP



**FACREM**  
£19 per 10cm  
N/A around a corner

#### CUT BACK IN DEPTH OF WORKTOP



**DECPROF**  
Whole worktop will be square edged  
£ 195

#### WORKTOP JOINT



**JOINT**  
Factory prepared butt & scribe  
£ 130

#### STRAIGHT FILLER



**EFILL56/96D**  
Includes extra laminate worktop and plinth  
£89 / £99

#### STRAIGHT TALL FILLER

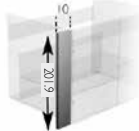

**EFILL201D**  
Includes extra plinth  
£ 119

#### CORNER FILLER



**EFILL56A**  
Includes extra laminate worktop and plinth  
£ 199

#### COLOUR-MATCHED SIDE



To visible side of unit  
£ 99 per side  
£ 199 for tall unit

# BASIN UNITS

56.4 CM HIGH UNITS / 27.6 CM HIGH PLINTH

## ALL PRICES INCLUDE

- HANDLES
- LAMINATE/FOIL WORKTOP WITHOUT UPSTAND
- PLINTH AND LEGS (WHEN REQUESTED)

🔧 We recommend the use of a super-slim self sealing trap with every basin unit

### BASIN UNIT



Depth (cm)	Code	Width (cm)	Price Group 0	Price Group 1	Price Group 2
33	<b>BU3350</b>	50	£737	£812	£870
	<b>BU3360</b>	60	£737	£812	£870
	<b>BU3370</b>	70	£819	£882	£889
	<b>BU3380</b>	80	£882	£940	£951

### REDUCED DEPTH BASIN UNIT



Depth (cm)	Code	Width (cm)	Price Group 0	Price Group 1	Price Group 2
20	<b>BU2050</b>	50	£737	£812	£870
	<b>BU2060</b>	60	£737	£812	£870
	<b>BU2070</b>	70	£819	£882	£889
	<b>BU2080</b>	80	£882	£940	£951

🔧 BU2050 not possible with SMO™ worktop

### SLIM BASIN UNIT

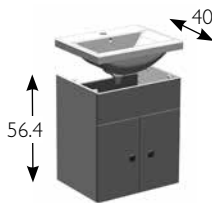

	Depth (cm)	Code	Width (cm)	Price Group 0	Price Group 1	Price Group 2
<b>BASIN</b>	40	<b>VAMBSL50</b>	51	£155	£155	£155
	40	<b>VAMBSL60</b>	61	£165	£165	£165
<b>UNIT</b>	37	<b>BU3750</b>	50	£649	£703	£754
	37	<b>BU3760</b>	60	£649	£703	£754

🔧 Only for use with Ceramic Slim Basin

### BASIN DRAWER UNIT

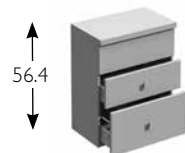

Depth (cm)	Code	Width (cm)	Price Group 0	Price Group 1	Price Group 2
33	<b>BUT3360</b>	60	£963	£1 033	£1 051
	<b>BUT3370</b>	70	£1 033	£1 114	£1 126
	<b>BUT3380</b>	80	£1 102	£1 191	£1 230

🔧 No moulding on Provence drawer fascias

### SUPER-SLIM TRAP



Code	Price
<b>SSTRAP</b>	£43

Individually ordered wastes, handles and ancillary items will incur a £10 P & P charge.

#### PLAIN END PANEL

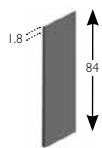

**CLAD22/3584**  
Includes extra laminate worktop (20 deep shown) £ 249  
£ 129

#### PLAIN TALL END PANEL

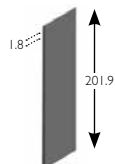

**CLAD22/35201**  
(20 deep shown)

#### PROVENCE END PANEL

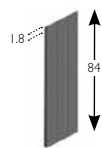

**EPANELPROV20/33**  
Includes extra laminate worktop (20 deep shown) £ 285  
£ 145

#### PROVENCE TALL END PANEL

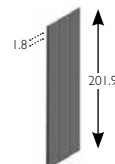

**EPANELPROVA20/33**  
(20 deep shown)

#### CURVED END PANEL

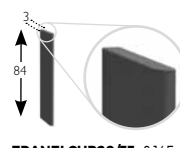

**EPANELCUR20/33** £ 145  
Includes extra laminate worktop with 14/19mm overhang and rounded end.  
Add **ZDECCUR** at £ 195 when used with SMO™ worktop

#### CURVED TALL END PANEL

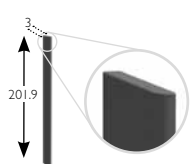

**EPANELACUR20/33**  
£ 285

# BASIN UNITS

56.4 CM HIGH UNITS / 27.6 CM HIGH PLINTH

## ALL PRICES INCLUDE

- HANDLES
- LAMINATE/FOIL WORKTOP WITHOUT UPSTAND
- PLINTH AND LEGS (WHEN REQUESTED)

❗ We recommend the use of a super-slim self sealing trap with every basin unit

### 60 OFFSET BASIN UNIT (RH shown)

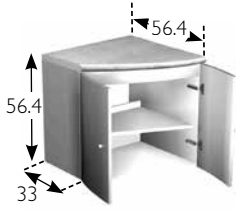

	Depth (cm)	Code	Width (cm)	Price Group 0	Price Group 1	Price Group 2
RH	33/56	DBA60R	60	N/A	£1 799	£1 888
LH	56/33	DBA60L	60	N/A	£1 799	£1 888

❗ Always square edged worktop. Laminate doors will have laminate horizontal edges with hand finished visible joint line. N/A with all handles due to shaped fronts. When using laminate or solid surface worktops check the size of the ceramic basin that you are using. Hinges and soft close mechanisms will operate differently on curved doors due to opposing closing angles

### REDUCED DEPTH 60 OFFSET BASIN UNIT (LH shown)

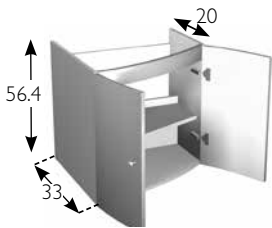

	Depth (cm)	Code	Width (cm)	Price Group 0	Price Group 1	Price Group 2
RH	20/33	DBA2060R	60	N/A	£1 453	£1 518
LH	33/20	DBA2060L	60	N/A	£1 453	£1 518

❗ N/A with laminate or solid surface worktops. Laminate doors will have laminate horizontal edges with hand finished visible joint line. N/A with all handles due to shaped fronts. Hinges and soft close mechanisms will operate differently on curved doors due to opposing closing angles

### 90 OFFSET BASIN UNIT (RH shown)



	Depth (cm)	Code	Width (cm)	Price Group 0	Price Group 1	Price Group 2
RH	33/56	ISE090R	90	N/A	£2 010	£2 116
LH	56/33	ISE090L	90	N/A	£2 010	£2 116

❗ Always square-edged worktop. Laminate doors will have laminate horizontal edges with hand finished visible joint line. N/A with all handles due to shaped fronts. When using laminate or solid surface worktops check the size of the ceramic basin that you are using. Hinges and soft close mechanisms will operate differently on curved doors due to opposing closing angles

### REDUCED DEPTH 90 OFFSET BASIN UNIT (LH shown)

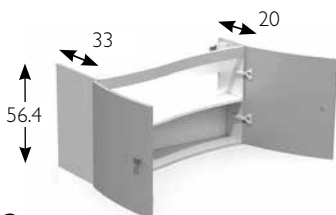

	Depth (cm)	Code	Width (cm)	Price Group 0	Price Group 1	Price Group 2
RH	20/33	ISE02090R	90	N/A	£1 799	£1 888
LH	33/20	ISE02090L	90	N/A	£1 799	£1 888

❗ N/A with laminate or solid surface top. Laminate doors will have laminate horizontal edges with hand finished visible joint line. N/A with all handles due to shaped fronts. Hinges and soft close mechanisms will operate differently on curved doors due to opposing closing angles

#### COLOUR-MATCHED SIDE



To visible side of unit  
£ 99 per side  
£ 199 for tall unit

#### UPSTAND ON WORKTOP

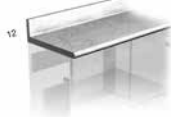

**FACREM**  
£ 19 per 10cm  
N/A around a corner

#### CUT BACK IN DEPTH OF WORKTOP

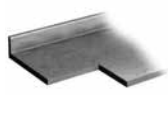

**DECPROF**  
Whole worktop will be square edged  
£ 195

#### WORKTOP JOINT



**JOINT**  
Factory prepared butt & scribe for laminate worktops  
£ 130

#### STRAIGHT FILLER

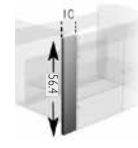

**EFILL56D**  
Includes extra laminate worktop and plinth  
£ 89

#### PLAIN END PANEL

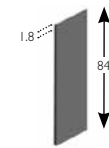

**CLAD22/3584**  
Includes extra laminate worktop (20 deep shown)  
£ 129



# BASIN UNITS

56.4 CM HIGH UNITS / 27.6 CM HIGH PLINTH

## ALL PRICES INCLUDE

- HANDLES
- LAMINATE/FOIL WORKTOP WITHOUT UPSTAND
- PLINTH AND LEGS (WHEN REQUESTED)

🔧 We recommend the use of a super-slim self sealing trap with every basin unit

### ROUNDED FRONT BASIN UNIT

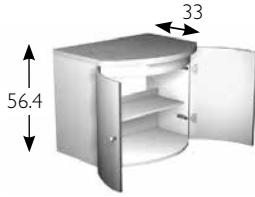

Depth (cm)	Code	Width (cm)	Price Group 0	Price Group 1	Price Group 2
33/51	<b>BA70</b>	70	N/A	£1 869	£1 962

🔧 Always square-edged worktop. Laminate doors will have laminate horizontal edges with hand finished visible joint line. N/A with all handles due to shaped fronts. When using laminate or solid surface worktops check the size of the ceramic basin that you are using.

### REDUCED DEPTH ROUNDED FRONT BASIN UNIT

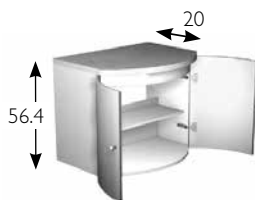

Depth (cm)	Code	Width (cm)	Price Group 0	Price Group 1	Price Group 2
20/38.3	<b>BA2055</b>	55	N/A	£1 314	£1 368
20/41.5	<b>BA2070</b>	70	N/A	£1 500	£1 565

🔧 Always square-edged worktop. Laminate doors will have laminate horizontal edges with hand finished visible joint line. N/A with all handles due to shaped fronts. When using laminate or solid surface worktops check the size of the ceramic basin that you are using.

### SUPER-SLIM TRAP



Code	Price
<b>SSTRAP</b>	£43

Individually ordered wastes, handles and ancillary items will incur a £10 P & P charge.

#### STRAIGHT FILLER

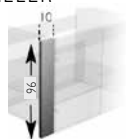

**EFILL96D**  
Includes extra laminate worktop and plinth  
£ 99

#### CORNER FILLER



**EFILL56A**  
Includes extra laminate worktop and plinth  
£ 199

#### CURVED END PANEL

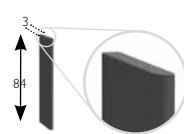

**EPANELCUR20/33** £ 145  
Includes extra laminate worktop with 14/19mm overhang and rounded end. Add **ZDECCUR** at £ 195 when used with SMO™ or solid surface worktops

#### PROVENCE END PANEL

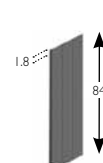

**EPANELPROV20/33/60**  
Includes extra laminate worktop (20 deep shown)  
£ 145



SMO™ WORKTOPS  
see page 24-27

BATH PANELS  
see page 29

MIRRORS  
see page 30-31

ANCILLARY ITEMS  
see page 36-37

# BASE UNITS

56.4 CM HIGH UNITS / 27.6 CM HIGH PLINTH

## ALL PRICES INCLUDE

- HANDLES
- LAMINATE/FOIL WORKTOP WITHOUT UPSTAND
- PLINTH AND LEGS (WHEN REQUESTED)

### 1 DOOR LEFT HAND



❗ 20cm wide door not possible with Provence moulding

Depth (cm)	Code	Width (cm)	Price Group 0	Price Group 1	Price Group 2
33	<b>B3320L</b>	20	£517	£556	£598
	<b>B3325L</b>	25	£517	£556	£598
	<b>B3330L</b>	30	£517	£556	£598
	<b>B3335L</b>	35	£556	£598	£645
	<b>B3340L</b>	40	£598	£626	£680
20	<b>B2020L</b>	20	£517	£556	£598
	<b>B2025L</b>	25	£517	£556	£598
	<b>B2030L</b>	30	£517	£556	£598
	<b>B2035L</b>	35	£556	£598	£645
	<b>B2040L</b>	40	£598	£626	£680

### 1 DOOR RIGHT HAND



❗ 20cm wide door not possible with Provence moulding

Depth (cm)	Code	Width (cm)	Price Group 0	Price Group 1	Price Group 2
33	<b>B3320R</b>	20	£517	£556	£598
	<b>B3325R</b>	25	£517	£556	£598
	<b>B3330R</b>	30	£517	£556	£598
	<b>B3335R</b>	35	£556	£598	£645
	<b>B3340R</b>	40	£598	£626	£680
20	<b>B2020R</b>	20	£517	£556	£598
	<b>B2025R</b>	25	£517	£556	£598
	<b>B2030R</b>	30	£517	£556	£598
	<b>B2035R</b>	35	£556	£598	£645
	<b>B2040R</b>	40	£598	£626	£680

### BASE UNIT 2 DOORS



❗ 40cm wide door not possible with Provence moulding

Depth (cm)	Code	Width (cm)	Price Group 0	Price Group 1	Price Group 2
33	<b>B3340</b>	40	£619	£662	£726
	<b>B3360</b>	60	£619	£662	£726
	<b>B3370</b>	70	£719	£762	£826
	<b>B3380</b>	80	£819	£862	£926
20	<b>B2040</b>	40	£619	£662	£726
	<b>B2060</b>	60	£619	£662	£726
	<b>B2070</b>	70	£719	£762	£826
	<b>B2080</b>	80	£819	£862	£926

### SLIDING DRAWER

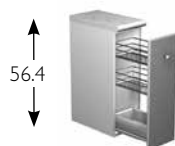

Depth (cm)	Code	Width (cm)	Price Group 0	Price Group 1	Price Group 2
33	<b>BC3320*</b>	20	£726	£777	£847

❗ Supplied with 2 inside metal basket trays.  
Provence moulding not possible on this unit

#### COLOUR-MATCHED SIDE



To visible side of unit  
£ 99 per side  
£ 199 for tall unit

#### UPSTAND ON WORKTOP



**FACREM**  
£ 19 per 10cm  
N/A around a corner

#### CUT BACK IN DEPTH OF WORKTOP

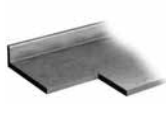

**DECPROF**  
Whole worktop will be square edged  
£ 195

#### WORKTOP JOINT



**JOINT**  
Factory prepared butt & scribe for laminate worktop  
£ 130

#### STRAIGHT FILLER



**EFILL56/96D**  
Includes extra laminate worktop and plinth  
£89 / £99

# BASE UNITS

56.4 CM HIGH UNITS / 27.6 CM HIGH PLINTH

## ALL PRICES INCLUDE

- HANDLES
- LAMINATE/FOIL WORKTOP WITHOUT UPSTAND
- PLINTH AND LEGS (WHEN REQUESTED)

### 1 DOOR, 1 DRAWER

(RH shown)



❗ No moulding on Provence drawer fascias

	Depth (cm)	Code	Width (cm)	Price Group 0	Price Group 1	Price Group 2
LH	33	BPT3330L	30	£819	£900	£940
		BPT3335L	35	£882	£940	£1 005
		BPT3340L	40	£923	£982	£1 051
RH	33	BPT3330R	30	£819	£900	£940
		BPT3335R	35	£882	£940	£1 005
		BPT3340R	40	£923	£982	£1 051

### 3 DRAWERS



❗ No moulding on Provence drawer fascias

	Depth (cm)	Code	Width (cm)	Price Group 0	Price Group 1	Price Group 2
	33	BT3315	15	£865	£912	£1 005
		BT3330	30	£865	£912	£1 005
		BT3335	35	£940	£982	£1 086
		BT3340	40	£963	£1 016	£1 126

### TOILET ROLL UNIT



CARCASE COLOURS

COLOURMATCHED INSIDE

	Depth (cm)	Code	Width (cm)	Price Group 0	Price Group 1	Price Group 2
CARCASE COLOURS	33	BTR3315	15	£568	£598	£626
	20	BTR2015	15	£568	£598	£626
COLOURMATCHED INSIDE	33	BTR3315C	15	£568	£777	£835
	20	BTR2015C	15	£568	£777	£835

❗ No handle with unit.

❗ Lift up door.

❗ No moulding on Provence door style

### TOILET ROLL DOOR UNIT

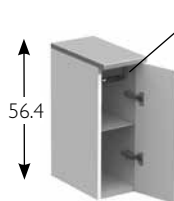

Toilet roll suspended from under worktop

❗ No moulding on Provence door style

	Depth (cm)	Code	Width (cm)	Price Group 0	Price Group 1	Price Group 2
LH	33	BTR3320L	20	£580	£610	£638
	20	BTR2020L	20	£580	£610	£638
RH	33	BTR3320R	20	£580	£610	£638
	20	BTR2020R	20	£580	£610	£638

#### CORNER FILLER



#### EFILL56A

Includes extra laminate worktop and plinth  
£ 199

#### CURVED END PANEL

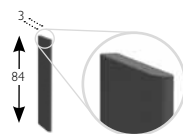

#### EPANELCUR20/33 £ 145

Includes extra laminate worktop with 14/19mm overhang and rounded end. Add **ZDECCUR** at £ 195 when used with SMO™ or solid surface worktops

#### PROVENCE END PANEL

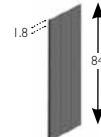

#### EPANELPROV20/33/60

Includes extra laminate worktop (20 deep shown)  
£ 145



SMO™ WORKTOPS  
see page 24-27

BATH PANELS  
see page 29

MIRRORS  
see page 30-31

ANCILLARY ITEMS  
see page 36-37

# BASE UNITS

56.4 CM HIGH UNITS / 27.6 CM HIGH PLINTH

## ALL PRICES INCLUDE

- HANDLES
- LAMINATE/FOIL WORKTOP WITHOUT UPSTAND
- PLINTH AND LEGS (WHEN REQUESTED)

### STRAIGHT CORNER UNIT

(RH shown)



	Depth (cm)	Code	Width (cm)	Price Group 0	Price Group 1	Price Group 2
LH	33	<b>BAB3350L</b>	50	£870	£940	£963
	33	<b>BAB3355L</b>	55	£940	£1 005	£1 033
	33	<b>BAB3360L</b>	60	£1 016	£1 102	£1 126
	20	<b>BAB2050L</b>	50	£870	£940	£963
	20	<b>BAB2055L</b>	55	£940	£1 005	£1 033
	20	<b>BAB2060L</b>	60	£1 016	£1 102	£1 126
RH	33	<b>BAB3350R</b>	50	£870	£940	£963
	33	<b>BAB3355R</b>	55	£940	£1 005	£1 033
	33	<b>BAB3360R</b>	60	£1 016	£1 102	£1 126
	20	<b>BAB2050R</b>	50	£870	£940	£963
	20	<b>BAB2055R</b>	55	£940	£1 005	£1 033
	20	<b>BAB2060R</b>	60	£1 016	£1 102	£1 126

1 Supplied with loose base 10cm filler. See page 38 for spacing requirement

### OPEN SHELF UNIT



Depth (cm)	Width (cm)	Carcase colours		Colourmatch inside (laminate and foil colours)	
		Code	Price	Code	Price
33	15	<b>BN3315</b>	£416	<b>BN3315C</b>	£614
	30	<b>BN3330</b>	£427	<b>BN3330C</b>	£614
	35	<b>BN3335</b>	£450	<b>BN3335C</b>	£614
	40	<b>BN3340</b>	£454	<b>BN3340C</b>	£682
20	15	<b>BN2015</b>	£416	<b>BN2015C</b>	£614
	30	<b>BN2030</b>	£427	<b>BN2030C</b>	£614
	35	<b>BN2035</b>	£450	<b>BN2035C</b>	£614
	40	<b>BN2040</b>	£454	<b>BN2040C</b>	£682

1 All open shelf units are supplied unassembled to allow for cutting down on site when necessary

#### COLOUR-MATCHED SIDE



To visible side of unit  
£ 99 per side  
£ 199 for tall unit

#### UPSTAND ON WORKTOP



**FACREM**  
£ 19 per 10cm  
N/A around a corner

#### CUT BACK IN DEPTH OF WORKTOP



**DECPROF**  
Whole worktop will be square edged  
£ 195

#### WORKTOP JOINT



**JOINT**  
Factory prepared butt & scribe for laminate worktops  
£ 130

#### STRAIGHT FILLER

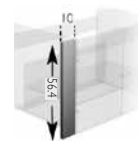

**EFILL56D**  
Includes extra laminate worktop and plinth  
£ 89

#### PLAIN END PANEL

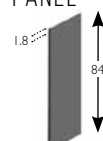

**CLAD22/3584**  
Includes extra laminate worktop (20 deep shown)  
£ 129

# CUT BACK BASE UNITS

56.4 CM HIGH UNITS / 27.6 CM HIGH PLINTH

## ALL PRICES INCLUDE

- HANDLES
- LAMINATE/FOIL WORKTOP WITHOUT UPSTAND
- PLINTH AND LEGS (WHEN REQUESTED)

### 1 DOOR ANGLED CUT BACK UNIT (LH shown)

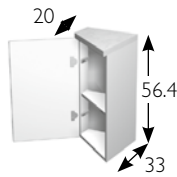

	Depth (cm)	Code	Width (cm)	Price Group 0	Price Group 1	Price Group 2
LH	20/33	<b>BPC3330L</b>	30	£765	£819	£847
RH	33/20	<b>BPC3330R</b>	30	£765	£819	£847

- ⓘ Restricted soft close action due to shape
- ⓘ Add **ZDECPS** at £195 when used with SMO™, Laminate/Foil or Solid surface worktops

### 1 DOOR ROUNDED CUT BACK UNIT (LH shown)

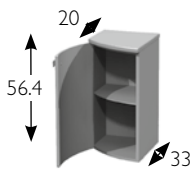

	Depth (cm)	Code	Width (cm)	Price Group 0	Price Group 1	Price Group 2
LH	20/33	<b>BRC3330L</b>	30	N/A	£923	£970
RH	33/20	<b>BRC3330R</b>	30	N/A	£923	£970

- ⓘ N/A with all handles due to shaped front
- ⓘ Add **ZDECRC** at £195 when used with SMO™, Laminate/Foil or Solid surface worktops
- ⓘ Hinges and soft close mechanisms will operate differently on curved doors due to closing angles

### 1 DOOR ROUNDED END UNIT (RH shown)

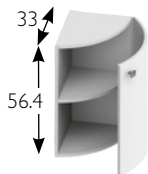

	Depth (cm)	Code	Width (cm)	Price Group 0	Price Group 1	Price Group 2
LH	0/33	<b>BA3330L</b>	30	N/A	£1 009	£1 056
RH	33/0	<b>BA3330R</b>	30	N/A	£1 009	£1 056
LH	0/20	<b>BA2030L</b>	30	N/A	£1 009	£1 056
RH	20/0	<b>BA2030R</b>	30	N/A	£1 009	£1 056

- ⓘ Add **ZDECBAT** at £195 when used with SMO™, Laminate/Foil or Solid surface worktops
- ⓘ N/A with all handles due to shaped front
- ⓘ please allow up to 25mm for worktop overhang
- ⓘ Hinges and soft close mechanisms will operate differently on curved doors due to closing angles
- ⓘ Includes rounded end plinth

#### PROVENCE END PANEL

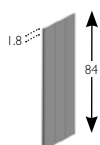

**EPANELPROV20/33**  
Includes extra laminate worktop (20 deep shown)  
£ 145

#### STRAIGHT FILLER

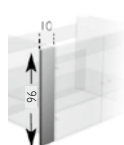

**EFILL96D**  
Includes extra laminate worktop and plinth  
£ 99

#### CORNER FILLER



**EFILL56A**  
Includes extra laminate worktop and plinth  
£ 199



SMO™ WORKTOPS  
see page 24-27

BATH PANELS  
see page 29

MIRRORS  
see page 30-31

ANCILLARY ITEMS  
see page 36-37



# HI-LINE WC UNITS

69.2 CM HIGH UNITS / 14.8 CM HIGH PLINTH

## HI-LINE WC UNIT

including ■ **GEBERIT** cistern

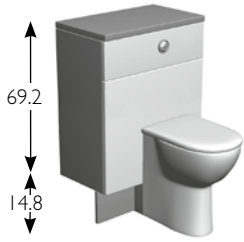

\* 40cm with ■ **Macdee** cistern and central button

❗ Not suitable for comfort height WC pans

### ALL PRICES INCLUDE

- HANDLES
- LAMINATE/FOIL WORKTOP WITHOUT UPSTAND
- PLINTH AND LEGS (WHEN REQUESTED)

Depth (cm)	Code	Width (cm)	Price Group 0	Price Group 1	Price Group 2
33	<b>WCHL3340*</b>	40	£923	£963	£1 079
	<b>WCHL3350</b>	50	£986	£1 051	£1 179
	<b>WCHL3360</b>	60	£1 016	£1 055	£1 191
	<b>WCHL3370</b>	70	£1 109	£1 160	£1 218
	<b>WCHL3380</b>	80	£1 160	£1 214	£1 295
20	<b>WCHL2040*</b>	40	£923	£963	£1 079
	<b>WCHL2050</b>	50	£986	£1 051	£1 179
	<b>WCHL2060</b>	60	£1 016	£1 055	£1 191
	<b>WCHL2070</b>	70	£1 109	£1 160	£1 218
	<b>WCHL2080</b>	80	£1 160	£1 214	£1 295

FOR WALL HUNG AND FLOOR MOUNTED WC UNITS SEE PAGE 2

## HI-LINE TOILET ROLL UNIT

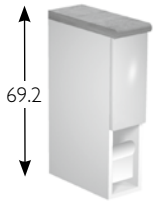

	Depth (cm)	Code	Width (cm)	Price Group 0	Price Group 1	Price Group 2
Carcase colours	33	<b>BTRHL3315</b>	15	£568	£598	£626
	20	<b>BTRHL2015</b>	15	£568	£598	£626
Colourmatched inside	33	<b>BTRHL3315C</b>	15	£568	£777	£835
	20	<b>BTRHL2015C</b>	15	£568	£777	£835

❗ No handle on unit

❗ No moulding on Provence door style

❗ Lift up door

## HI-LINE TOILET ROLL DOOR UNIT

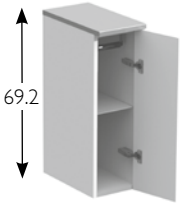

	Depth (cm)	Code	Width (cm)	Price Group 0	Price Group 1	Price Group 2
LH	33	<b>BTRHL3320L</b>	20	£580	£610	£638
	20	<b>BTRHL2020L</b>	20	£580	£610	£638
RH	33	<b>BTRHL3320R</b>	20	£580	£610	£638
	20	<b>BTRHL2020R</b>	20	£580	£610	£638

## HI-LINE BIDET UNIT

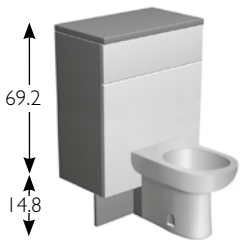

Depth (cm)	Code	Width (cm)	Price Group 0	Price Group 1	Price Group 2
33	<b>BBIHL3350</b>	50	£696	£742	£882
	<b>BBIHL3360</b>	60	£714	£765	£900
	<b>BBIHL3370</b>	70	£796	£865	£916
20	<b>BBIHL2050</b>	50	£696	£742	£882
	<b>BBIHL2060</b>	60	£714	£765	£900
	<b>BBIHL2070</b>	70	£796	£865	£916

FOR WALL HUNG AND FLOOR MOUNTED BIDET UNITS SEE PAGE 4

### COLOURMATCHED SIDE



To visible side of unit  
£ 99 per side  
£ 199 for tall unit

### UPSTAND ON WORKTOP

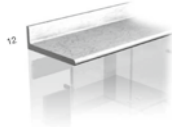

**FACREM**  
£ 19 per 10cm  
N/A around a corner

### CUT BACK IN DEPTH OF WORKTOP

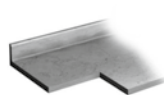

**DECPROF**  
Whole worktop will be square edged  
£ 195

### WORKTOP JOINT

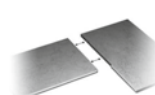

**JOINT**  
Factory prepared butt & scribe for laminate worktops.  
£ 130

### PLAIN END PANEL

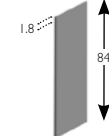

**CLAD22/3584**  
Includes extra laminate worktop (20 deep shown)  
£ 129

# HI-LINE BASIN UNITS

69.2 CM HIGH UNITS / 14.8 CM HIGH PLINTH

## ALL PRICES INCLUDE

- HANDLES
- LAMINATE/FOIL WORKTOP
- PLINTH AND LEGS (WHEN REQUESTED)

🔧 We recommend the use of a super-slim self sealing trap with every basin unit

## HI-LINE BASIN UNIT

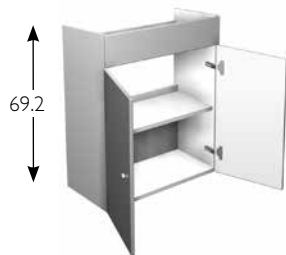

Depth (cm)	Code	Width (cm)	Price Group 0	Price Group 1	Price Group 2
33	<b>BUHL3350</b>	50	£737	£812	£870
	<b>BUHL3360</b>	60	£737	£812	£870
	<b>BUHL3370</b>	70	£819	£882	£889
	<b>BUHL3380</b>	80	£882	£940	£951
20	<b>BUHL2050</b>	50	£737	£812	£870
	<b>BUHL2060</b>	60	£737	£812	£870
	<b>BUHL2070</b>	70	£819	£882	£889
	<b>BUHL2080</b>	80	£882	£940	£951

🔧 BUHL2050 Not possible with SMO™ Worktop

## HI-LINE BASIN DRAWER UNIT



Depth (cm)	Code	Width (cm)	Price Group 0	Price Group 1	Price Group 2
33	<b>BUTHL3360</b>	60	£963	£1 033	£1 051
	<b>BUTHL3370</b>	70	£1 033	£1 114	£1 126
	<b>BUTHL3380</b>	80	£1 102	£1 191	£1 230

🔧 No moulding on Provence drawer fascias

## SLIM BASIN UNIT

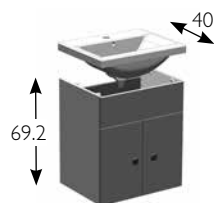

	Depth (cm)	Code	Width (cm)	Price Group 0	Price Group 1	Price Group 2
<b>BASIN</b>	40	<b>VAMBSL50</b>	51	£155	£155	£155
	40	<b>VAMBSL60</b>	61	£165	£165	£165
<b>UNIT</b>	37	<b>BUHL3750</b>	50	£649	£703	£754
	37	<b>BUHL3760</b>	60	£649	£703	£754

🔧 Only for use with Ceramic Slim Basin

## SUPER-SLIM TRAP



Code	Price
<b>SSTRAP</b>	£43

Individually ordered wastes, handles and ancillary items will incur a £10 P & P charge.

## HI-LINE CORNER FILLER



**EFILL69A**  
Includes extra laminate worktop and plinth  
£ 225

## STRAIGHT FILLER

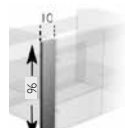

**EFILL69D**  
Includes extra laminate worktop and plinth  
£ 99

## PROVENCE END PANEL

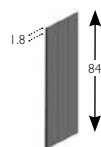

**EPANELPROV20/33/60**  
Includes extra laminate worktop (20 deep shown)  
£ 145



**SMO™ WORKTOPS**  
see page **24-27**

**BATH PANELS**  
see page **29**

**MIRRORS**  
see page **30-31**

**ANCILLARY ITEMS**  
see page **36-37**

# HI-LINE UNITS

69.2 CM HIGH UNITS / 14.8 CM HIGH PLINTH

## ALL PRICES INCLUDE

- HANDLES
- LAMINATE/FOIL WORKTOP
- PLINTH AND LEGS (WHEN REQUESTED)

### HI-LINE BASE UNIT 2 DOORS

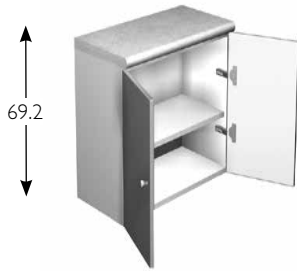

! 40cm wide door not possible with Provence moulding

Depth (cm)	Code	Width (cm)	Price Group 0	Price Group 1	Price Group 2
33	<b>BHL3340</b>	40	£819	£912	£951
	<b>BHL3360</b>	60	£819	£912	£951
	<b>BHL3370</b>	70	£912	£982	£1 033
	<b>BHL3380</b>	80	£982	£1 074	£1 121
20	<b>BHL2040</b>	40	£819	£912	£951
	<b>BHL2060</b>	60	£819	£912	£951
	<b>BHL2070</b>	70	£912	£982	£1 033
	<b>BHL2080</b>	80	£982	£1 074	£1 121

### HI-LINE 1 DOOR LEFT HAND



! 20cm wide door not possible with Provence moulding

Depth (cm)	Code	Width (cm)	Price Group 0	Price Group 1	Price Group 2
33	<b>BHL3320L</b>	20	£517	£556	£598
	<b>BHL3325L</b>	25	£517	£556	£598
	<b>BHL3330L</b>	30	£517	£556	£598
	<b>BHL3335L</b>	35	£556	£598	£645
	<b>BHL3340L</b>	40	£598	£626	£680
20	<b>BHL2020L</b>	20	£517	£556	£598
	<b>BHL2025L</b>	25	£517	£556	£598
	<b>BHL2030L</b>	30	£517	£556	£598
	<b>BHL2035L</b>	35	£556	£598	£645
	<b>BHL2040L</b>	40	£598	£626	£680

### HI-LINE 1 DOOR RIGHT HAND

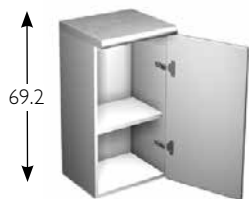

! 20cm wide door not possible with Provence moulding

Depth (cm)	Code	Width (cm)	Price Group 0	Price Group 1	Price Group 2
33	<b>BHL3320R</b>	20	£517	£556	£598
	<b>BHL3325R</b>	25	£517	£556	£598
	<b>BHL3330R</b>	30	£517	£556	£598
	<b>BHL3335R</b>	35	£556	£598	£645
	<b>BHL3340R</b>	40	£598	£626	£680
20	<b>BHL2020R</b>	20	£517	£556	£598
	<b>BHL2025R</b>	25	£517	£556	£598
	<b>BHL2030R</b>	30	£517	£556	£598
	<b>BHL2035R</b>	35	£556	£598	£645
	<b>BHL2040R</b>	40	£598	£626	£680

#### COLOUR-MATCHED SIDE



To visible side of unit  
£ 99 per side  
£ 199 for tall unit

#### UPSTAND ON WORKTOP



**FACREM**  
£ 19 per 10cm  
N/A around a corner

#### CUT BACK IN DEPTH OF WORKTOP



**DECPROF**  
Whole worktop will be square edged  
£ 195

#### WORKTOP JOINT



**JOINT**  
Factory prepared butt & scribe for laminate worktops  
£ 130

#### STRAIGHT FILLER



**EFILL96D**  
Includes extra laminate worktop and plinth  
£ 99

#### PLAIN END PANEL

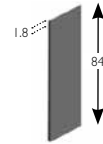

**CLAD22/3584**  
Includes extra laminate worktop (20 deep shown)  
£ 129

# HI-LINE UNITS

69.2 CM HIGH UNITS / 14.8 CM HIGH PLINTH

## ALL PRICES INCLUDE

- HANDLES
- LAMINATE/FOIL WORKTOP
- PLINTH AND LEGS (WHEN REQUESTED)

### HI-LINE 1 DOOR, 1 DRAWER

(RH shown)



LH

RH

Depth (cm)	Code	Width (cm)	Price Group 0	Price Group 1	Price Group 2
33	<b>BPTHL3330L</b>	30	£819	£900	£940
	<b>BPTHL3335L</b>	35	£882	£940	£1 005
	<b>BPTHL3340L</b>	40	£923	£982	£1 051
33	<b>BPTHL3330R</b>	30	£819	£900	£940
	<b>BPTHL3335R</b>	35	£882	£940	£1 005
	<b>BPTHL3340R</b>	40	£923	£982	£1 051

❗ No moulding on Provence drawer fascia

### HI-LINE 4 DRAWER UNIT

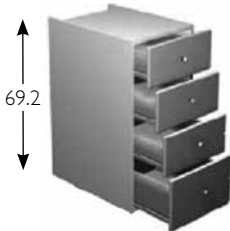

Depth (cm)	Code	Width (cm)	Price Group 0	Price Group 1	Price Group 2
33	<b>BTHL3330</b>	30	£865	£912	£1 005
	<b>BTHL3335</b>	35	£940	£982	£1 086
	<b>BTHL3340</b>	40	£963	£1 016	£1 126

❗ No moulding on Provence drawer fascias

### HI-LINE 1 DOOR ANGLED CUT BACK UNIT (LH shown)

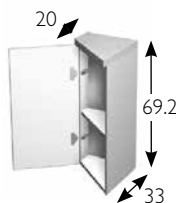

LH

RH

Depth (cm)	Code	Width (cm)	Price Group 0	Price Group 1	Price Group 2
20/33	<b>BPCHL3330L</b>	30	£765	£819	£847
33/20	<b>BPCHL3330R</b>	30	£765	£819	£847

❗ Restricted soft close action due to shape

❗ Add **ZDECPS** at £195 when used with SMO™, Laminate/Foil or Solid surface worktops

#### HI-LINE CORNER FILLER



##### EFILL69A

Includes extra laminate worktop and plinth  
£ 225

#### CURVED END PANEL

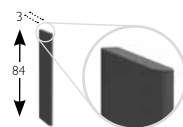

##### EPANELCUR20/33 £145

Includes extra laminate worktop with 14/19mm overhang and rounded end.  
Add **ZDECUR** at £ 195 when used with SMO™ worktop

#### PROVENCE END PANEL

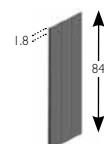

##### EPANELPROV20/33/60

Includes extra laminate worktop (20 deep shown)  
£ 145



SMO™ WORKTOPS  
see page 24-27

BATH PANELS  
see page 29

MIRRORS  
see page 30-31

ANCILLARY ITEMS  
see page 36-37

# 50CM DEEP UNITS

## 56.4 CM HIGH UNITS

### BASIN UNIT WITH 2 FULL HEIGHT DOORS



Depth (cm)	Code	Width (cm)	Price Group 0	Price Group 1	Price Group 2
47.5	<b>BV564760</b>	60	£1 051	£1 144	£1 172
	<b>BV564770</b>	70	£1 144	£1 214	£1 253
	<b>BV564780</b>	80	£1 202	£1 295	£1 323
	<b>BV564790</b>	90	£1 284	£1 381	£1 411

① For inset countertop basin

#### ALL PRICES INCLUDE

- HANDLES
- LAMINATE/FOIL WORKTOP WITHOUT UPSTAND
- PLINTH AND LEGS (WHEN REQUESTED)

### BASIN UNIT WITH 2 DRAWERS



Depth (cm)	Code	Width (cm)	Price Group 0	Price Group 1	Price Group 2
47.5	<b>BVC564760</b>	60	£1 160	£1 230	£1 284
	<b>BVC564770</b>	70	£1 242	£1 323	£1 381
	<b>BVC564780</b>	80	£1 318	£1 411	£1 462
	<b>BVC564790</b>	90	£1 393	£1 497	£1 551

① For Sit-on bowl or SMO™ top with square or Dolce bowl. Super slim self sealing waste/trap SSTRAP always required. Not suitable for Inset ceramic bowl due to top drawer.

### 1 DOOR UNIT (RH shown)



	Depth (cm)	Code	Width (cm)	Price Group 0	Price Group 1	Price Group 2
LH	47.5	<b>B564730L</b>	30	£742	£796	£807
	47.5	<b>B564735L</b>	35	£777	£835	£865
	47.5	<b>B564740L</b>	40	£819	£882	£912
RH	47.5	<b>B564730R</b>	30	£742	£796	£807
	47.5	<b>B564735R</b>	35	£777	£835	£865
	47.5	<b>B564740R</b>	40	£819	£882	£912

### 2 DRAWER UNIT

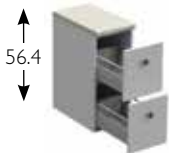

Depth (cm)	Code	Width (cm)	Price Group 0	Price Group 1	Price Group 2
47.5	<b>BT564730</b>	30	£993	£1 044	£1 149
	<b>BT564735</b>	35	£1 079	£1 126	£1 249
	<b>BT564740</b>	40	£1 109	£1 167	£1 300

**A LARGER SELECTION OF 50CM & 60CM DEEP BASE AND 60CM DEEP TALL UNITS ARE AVAILABLE FROM OUR FRENCH RANGE.**

**CONTACT OUR SALES OFFICE FOR MORE INFORMATION:  
01925 852675**

#### CUT BACK IN DEPTH OF WORKTOP



**DECPROF**  
Whole worktop will be square edged  
£195

#### STRAIGHT FILLER

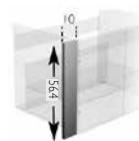

**EFILL56D**  
Includes extra laminate worktop and plinth  
£89

#### PLAIN END PANEL

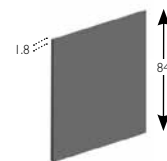

**CLAD4984**  
Includes extra laminate worktop (49.5 deep shown)  
£145



# 60CM DEEP UNITS

56.4 CM HIGH UNITS / 27.6 CM HIGH PLINTH

## ALL PRICES INCLUDE

- HANDLES
- LAMINATE/FOIL WORKTOP WITHOUT UPSTAND
- PLINTH AND LEGS (WHEN REQUESTED)

### BASIN UNIT WITH 2 FULL HEIGHT DOORS



Depth (cm)	Code	Width (cm)	Price Group 0	Price Group 1	Price Group 2
56.4	<b>BFD5660</b>	60	£1 051	£1 144	£1 172
	<b>BFD5670</b>	70	£1 144	£1 214	£1 253
	<b>BFD5680</b>	80	£1 202	£1 295	£1 323
	<b>BFD5690</b>	90	£1 284	£1 381	£1 411
	<b>BFD56100</b>	100	£1 335	£1 458	£1 486

❗ For inset countertop basin, laminate or SMO™ top

### BASIN UNIT WITH 2 DRAWERS



Depth (cm)	Code	Width (cm)	Price Group 0	Price Group 1	Price Group 2
56.4	<b>BVC565660</b>	60	£1 160	£1 230	£1 284
	<b>BVC565670</b>	70	£1 242	£1 323	£1 381
	<b>BVC565690</b>	90	£1 393	£1 497	£1 551

❗ For Sit-on bowl or SMO™ top. Super slim self sealing waste/trap SSTRAP always required. Not suitable for Inset ceramic bowl due to top drawer. Use SMO™ Dolce or square style.

### 1 DOOR UNIT (RH shown)



	Depth (cm)	Code	Width (cm)	Price Group 0	Price Group 1	Price Group 2
LH	56.4	<b>B5630L</b>	30	£742	£796	£807
		<b>B5635L</b>	35	£777	£835	£865
		<b>B5640L</b>	40	£819	£882	£912
RH	56.4	<b>B5630R</b>	30	£742	£796	£807
		<b>B5635R</b>	35	£777	£835	£865
		<b>B5640R</b>	40	£819	£882	£912

### 3 DRAWER UNIT

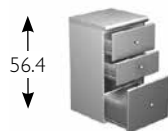

Depth (cm)	Code	Width (cm)	Price Group 0	Price Group 1	Price Group 2
56.4	<b>BT5630</b>	30	£951	£1 005	£1 102
	<b>BT5635</b>	35	£1 033	£1 079	£1 195
	<b>BT5640</b>	40	£1 063	£1 121	£1 242

❗ No moulding on Provence drawer fascias

#### UPSTAND ON WORKTOP



**FACREM**  
£ 19 per 10cm  
N/A around a corner

#### WORKTOP JOINT



**JOINT**  
Factory prepared butt & scribe for laminate worktops  
£ 130

#### CORNER FILLER



**EFILL56A**  
Includes extra laminate worktop and plinth  
£ 199

#### PLAIN END PANEL

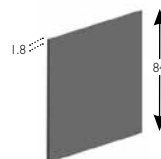

**CLAD5884**  
Includes extra laminate worktop (58.4 deep shown)  
£ 145

#### PROVENCE END PANEL

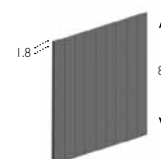

**EPANELPROV60**  
Includes extra laminate worktop  
£ 145

# TALL UNITS

174.3 CM HIGH UNITS / 27.6 CM HIGH PLINTH

## ALL PRICES INCLUDE

- HANDLES
- PLINTH AND LEGS (WHEN REQUESTED)

### 2 DOORS LEFT HAND

(short door top, tall door at bottom)

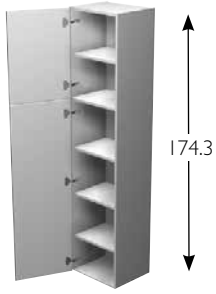

Depth (cm)	Code	Width (cm)	Price Group 0	Price Group 1	Price Group 2
33	<b>A3330L</b>	30	£738	£765	£819
	<b>A3335L</b>	35	£777	£819	£870
	<b>A3340L</b>	40	£835	£865	£923
20	<b>A2030L</b>	30	£738	£765	£819
	<b>A2035L</b>	35	£777	£819	£870
	<b>A2040L</b>	40	£835	£865	£923

### 2 DOORS RIGHT HAND

(short door top, tall door at bottom)

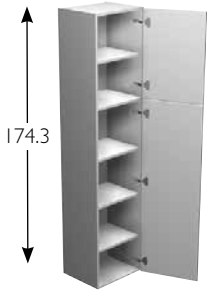

Depth (cm)	Code	Width (cm)	Price Group 0	Price Group 1	Price Group 2
33	<b>A3330R</b>	30	£738	£765	£819
	<b>A3335R</b>	35	£777	£819	£870
	<b>A3340R</b>	40	£835	£865	£923
20	<b>A2030R</b>	30	£738	£765	£819
	<b>A2035R</b>	35	£777	£819	£870
	<b>A2040R</b>	40	£835	£865	£923

### 2 DOORS, 1 DRAWER

(RH shown)



	Depth (cm)	Code	Width (cm)	Price Group 0	Price Group 1	Price Group 2
<b>LH</b>	33	<b>AT3330L</b>	30	£982	£1 021	£1 102
		<b>AT3335L</b>	35	£1 016	£1 074	£1 144
		<b>AT3340L</b>	40	£1 086	£1 126	£1 202
<b>RH</b>	33	<b>AT3330R</b>	30	£982	£1 021	£1 102
		<b>AT3335R</b>	35	£1 016	£1 074	£1 144
		<b>AT3340R</b>	40	£1 086	£1 126	£1 202

❗ No moulding on Provence drawer fascia



SMO™ WORKTOPS  
see page 24-27

BATH PANELS  
see page 29

MIRRORS  
see page 30-31

ANCILLARY ITEMS  
see page 36-37

COLOURMATCHED  
SIDE



To visible side of unit  
£ 199 for tall unit

STRAIGHT  
TALL FILLER

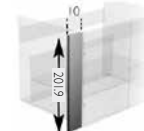

**EFILL201D**  
Includes extra plinth  
£ 119

# HI-LINE TALL UNITS

187 CM HIGH UNITS / 14.8 CM HIGH PLINTH

**ALL PRICES INCLUDE**

- HANDLES
- PLINTH AND LEGS (WHEN REQUESTED)

## HI-LINE 2 DOORS LEFT HAND

(short door top, tall door at bottom)

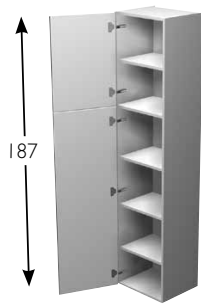

Depth (cm)	Code	Width (cm)	Price Group 0	Price Group 1	Price Group 2
33	<b>AHL3330L</b>	30	£738	£765	£819
	<b>AHL3335L</b>	35	£777	£819	£870
	<b>AHL3340L</b>	40	£835	£865	£923
20	<b>AHL2030L</b>	30	£738	£765	£819
	<b>AHL2035L</b>	35	£777	£819	£870
	<b>AHL2040L</b>	40	£835	£865	£923

## HI-LINE 2 DOORS RIGHT HAND

(short door top, tall door at bottom)

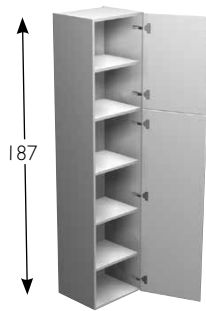

Depth (cm)	Code	Width (cm)	Price Group 0	Price Group 1	Price Group 2
33	<b>AHL3330R</b>	30	£738	£765	£819
	<b>AHL3335R</b>	35	£777	£819	£870
	<b>AHL3340R</b>	40	£835	£865	£923
20	<b>AHL2030R</b>	30	£738	£765	£819
	<b>AHL2035R</b>	35	£777	£819	£870
	<b>AHL2040R</b>	40	£835	£865	£923

## HI-LINE 2 DOORS 1 DRAWER

(RH shown)

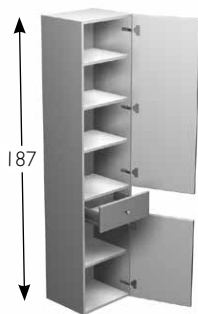

	Depth (cm)	Code	Width (cm)	Price Group 0	Price Group 1	Price Group 2
<b>LH</b>	33	<b>ATHL3330L</b>	30	£982	£1 021	£1 102
		<b>ATHL3335L</b>	35	£1 016	£1 074	£1 144
		<b>ATHL3340L</b>	40	£1 086	£1 126	£1 202
<b>RH</b>	33	<b>ATHL3330R</b>	30	£982	£1 021	£1 102
		<b>ATHL3335R</b>	35	£1 016	£1 074	£1 144
		<b>ATHL3340R</b>	40	£1 086	£1 126	£1 202

❶ No moulding on Provence drawer fascia

### CURVED TALL END PANEL

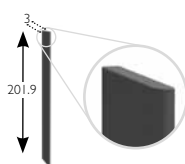

**EPANELACUR20/33**  
£ 285

### PROVENCE TALL END PANEL

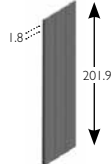

**EPANELPROVA20/33**  
(20 deep shown)  
£ 285

### PLAIN TALL END PANEL

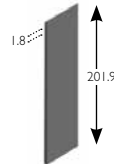

**CLAD22/35201**  
(20 deep shown)  
£ 249



**SMO™ WORKTOPS**  
see page **24-27**

**BATH PANELS**  
see page **29**

**MIRRORS**  
see page **30-31**

**ANCILLARY ITEMS**  
see page **36-37**

## SHORT WALL UNITS

### 1 DOOR

(RH shown)



	Depth (cm)	Code	Width (cm)	Price Group 0	Price Group 1	Price Group 2
LH	18	H5620L	20	£463	£494	£517
		H5630L	30	£463	£494	£517
		H5635L	35	£470	£494	£545
		H5640L	40	£487	£529	£563
RH	18	H5620R	20	£463	£494	£517
		H5630R	30	£463	£494	£517
		H5635R	35	£470	£494	£545
		H5640R	40	£487	£529	£563

### 2 DOORS



	Depth (cm)	Code	Width (cm)	Price Group 0	Price Group 1	Price Group 2
	18	H5660	60	£610	£645	£680
		H5670	70	£610	£656	£696
		H5680	80	£638	£680	£714

Individually ordered wastes, handles and ancillary items will incur a £10 P & P charge.



SMO™ WORKTOPS  
see page 24-27

BATH PANELS  
see page 29

MIRRORS  
see page 30-31

ANCILLARY ITEMS  
see page 36-37

#### STRAIGHT WALL FILLER

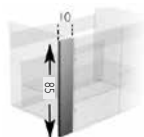

**EFILL85D**  
£ 95

#### PROVENCE WALL END PANEL

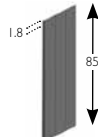

**EPANELHPROV18**  
£ 125

#### COLOURMATCHED SIDE



To visible side of unit  
£ 99 per side

## TALL WALL UNITS

### 1 DOOR

(RH shown)



	Depth (cm)	Code	Width (cm)	Price Group 0	Price Group 1	Price Group 2
LH	18	H8520L	20	£487	£517	£556
		H8530L	30	£487	£517	£556
		H8535L	35	£494	£533	£568
		H8540L	40	£505	£556	£580
RH	18	H8520R	20	£487	£517	£556
		H8530R	30	£487	£517	£556
		H8535R	35	£494	£533	£568
		H8540R	40	£505	£556	£580

### 2 DOORS



	Depth (cm)	Code	Width (cm)	Price Group 0	Price Group 1	Price Group 2
18	18	H8560	60	£645	£696	£726
		H8570	70	£649	£699	£738
		H8580	80	£680	£726	£777

Individually ordered wastes, handles and ancillary items will incur a £10 P & P charge.

<p><b>STRAIGHT WALL FILLER</b></p> <p><b>EFILL85D</b> £ 95</p>	<p><b>PROVENCE WALL END PANEL</b></p> <p><b>EPANELPROV18</b> £ 125</p>	<p><b>COLOURMATCHED SIDE</b></p> <p>To visible side of unit £ 99 per side</p>
--	--	---



# PANORAMIC MIRRORS

## TALL MIRROR ON FULL UPSTAND

Includes mirror fixing rails

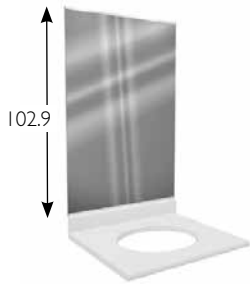

- ❗ FIXEMIDECO clips required when used without light pelmet
- ❗ For special size, take price of superior dimension +15%

Code	Width (cm)	Price
MID50	50	£261
MID60	60	£289
MID70	70	£319
MID80	80	£371
MID90	90	£424
MID100	100	£494
MID110	110	£505
MID120	120	£556
MID130	130	£598
MID140	140	£645
MID150	150	£696
MID160	160	£738

## TALL MIRROR ON MINI UPSTAND

Includes mirror fixing rails

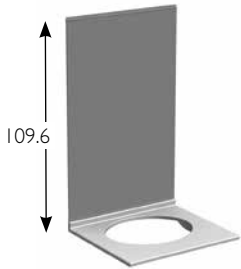

- ❗ FIXEMIDECO clips required when used without light pelmet
- ❗ For special size, take price of superior dimension +15%

Code	Width (cm)	Price
MIV50	50	£261
MIV60	60	£289
MIV70	70	£319
MIV80	80	£371
MIV90	90	£424
MIV100	100	£494
MIV110	110	£505
MIV120	120	£556
MIV130	130	£598
MIV140	140	£645
MIV150	150	£696
MIV160	160	£738

# WALL SHELVING PANELS

## MODEL A

Mirrored back panel.  
Glass shelves. Includes mirror fixing rails

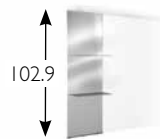

To be placed by MID mirror. 2 shelves centred on total height.

Code	Width (cm)	Price
PANELMA30	30	£324
PANELMA35	35	£324
PANELMA40	40	£324

- ❗ FIXEMIDECO clips required when used without light pelmet

## MODEL C

Mirrored back panel.  
Glass shelves. Includes mirror fixing rails



To be placed between upstand and underneath short wall unit.  
1 shelf centred on total height.

Code	Width (cm)	Price
PANELMC30	30	£324
PANELMC35	35	£324
PANELMC40	40	£324

- ❗ FIXEMIDECO clips required when used without light pelmet

## MODEL G

Mirrored back panel.  
Glass shelf Includes mirror fixing rails

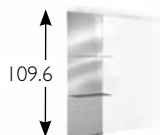

To be placed by MIV mirror. 2 shelves centred on total height.

Code	Width (cm)	Price
PANELMG30	30	£324
PANELMG35	35	£324
PANELMG40	40	£324

- ❗ FIXEMIDECO clips required when used without light pelmet

# LIGHT PELMETS

## LIGHTING PELMETS

Includes Chrome LED spotlights  
(4000k - IP44 Rated)



❗ Laminate colours have bullnose profile, foil colours have square edged profile.

❗ For special size, take the price of superior dimension and + 15%.

❗ Maximum length for foil colours is 200cm.

Code	Width (cm)	Spotlights	Price
LP1750	50	2	£459
LP1760	60	2	£470
LP1770	70	2	£487
LP1780	80	3	£517
LP1790	90	3	£598
LP1795	95	3	£610
LP17100	100	3	£614
LP17105	105	3	£626
LP17110	110	4	£645
LP17115	115	4	£673
LP17120	120	4	£707
LP17125	125	4	£726
LP17130	130	4	£726
LP17135	135	4	£738
LP17140	140	4	£749
LP17145	145	4	£777
LP17150	150	5	£870
LP17155	155	5	£889
LP17160	160	5	£900
LP17165	165	5	£923
LP17170	170	5	£951
LP17175	175	5	£963
LP17180	180	5	£1 016
LP17185	185	5	£1 051
LP17190	190	5	£1 102
LP17195	195	5	£1 144
LP17200	200	6	£1 074
LP17210	210	6	£1 253
LP17220	220	6	£1 284
LP17230	230	6	£1 311
LP17240	240	7	£1 381
LP17250	250	7	£1 400

Individually ordered wastes, handles and ancillary items will incur a £10 P & P charge.

### EXTRA LENGTH MIRROR FIXING RAIL



**MRAIL**  
Per linear metre  
£ 28

### MIRROR FILLER



❗ Not suitable for use with MIV mirror

**MFILL102D**  
H1029 x W100mm  
To fill gap between mirror and wall. Colour to match front with 1 square edge, 1 rounded edge.  
£ 285

### SPARE LIGHT PELMET BRACKET



**LPBRACK**  
Spare Pelmet fixing bracket  
£ 10

### ANTIMIST HEATED MIRROR PAD

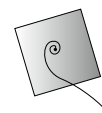

**ANTIMIST**  
H40 x W35cm  
to be connected to mains  
£ 130

### MIRROR CLIPS



**FIXEMIDECO**  
Mirror fixing spring clips (box of 4) for fixing mirror without MRAIL  
£ 27

**WE DO NOT RECOMMEND  
THE USE OF SMO™ BASINS  
AND WORKTOPS WITH WATER  
TEMPERATURE OVER 60°C.**

# SMO™

## WORKTOPS

## SHELVES

## WINDOW SILLS

SMO™ is a cast material made from natural calcium carbonate and polyester. It is coloured using organic powder pigments and baked to 80° Celcius to ensure stability. It is coated with a sanitary gel coat during its manufacture and can be cut or drilled using normal woodworking tools and a jigsaw with fine tooth sharp blade.

SMO™ is a hand moulded material that will have slight imperfections in size, flatness, dimples and some shade variations. This is all part of the tolerances of this modern moulded material and cannot be exchanged or refunded under the guarantee policy.

All SMO™ basins will be supplied with one tap hole and in Gloss White unless otherwise specified.

## SMO™ WORKTOP WITH 1 BASIN

Extra price to upgrade worktop from laminated without upstand to SMO™.  
For SMO™ worktop without units, add £30 per 10cm on top of upgrade price.

All basin designs are at the same price.  
For intermediary length, take price of the superior dimension

For bowl design and worktop shape take code from the following 2 pages.

❶ Always check maximum length/distances and bowl position according to mould limitations shown on each drawing.

❷ Double bowl only possible with full depth 50 or 60 deep inset worktops.  
Minimum 70cm between centre of basins.

**EXTRA BASIN + £482**

❸ All SMO basins are supplied with one tap hole unless specified without.





Length (cm)	Upgrade price without upstand	Upgrade price with upstand
50	£762	£865
60	£762	£865
70	£830	£940
80	£905	£1 016
90	£962	£1 102
100	£1 053	£1 202
110	£1 134	£1 265
120	£1 195	£1 365
130	£1 270	£1 439
140	£1 339	£1 532
150	£1 411	£1 620
160	£1 500	£1 690
170	£1 570	£1 771
180	£1 640	£1 864
190	£1 702	£1 939
200	£1 775	£2 015
210	£1 862	£2 097
220	£1 935	£2 194
230	£1 992	£2 271
240	£2 071	£2 345
250	£2 151	£2 422

## SMO™ WORKTOP WITHOUT MOULDED BASIN

Also used for shelves and window sills etc.

	Code	Depth (cm)	Price per 10cm
<b>With upstand (Specify mini or standard upstand)</b>	ZTABR230	23.5	£80
	ZTABR360	36.5	£99
	ZTABR50	50	£99
	ZTABR60	60	£99
<b>Without upstand</b>	ZTAB230	23.5	£64
	ZTAB360	36.5	£76
	ZTAB50	50	£92
	ZTAB60	60	£92

Individually ordered wastes, handles and ancillary items will incur a £10 P & P charge.

<p><b>SMO™ REPAIR KIT</b></p>  <p><b>KITSMOC</b> includes polishing kit £ 99</p>	<p><b>SMO™ POLISHING KIT</b></p>  <p><b>KITSMOP</b> £ 79</p>	<p><b>SPARE OVERFLOWS</b></p>  <p><b>KITOVER/KITROPOLEINNO</b> External overflow complete with chrome / black ring £ 35</p>	<p><b>SMO™ JOINT</b></p>  <p><b>ENJTPBLC</b> White overflow ring £ 35</p> <p><b>ENJTPO</b> Gold overflow ring £ 35</p>	<p><b>CUT BACK IN DEPTH OF SMO™ WORKTOP</b></p>  <p><b>ZDECPROF</b> £ 195</p>
			<p><b>JOINT</b> The 2 worktops will be square edged and butt one against the other £ 130</p>	

**WE DO NOT RECOMMEND  
THE USE OF SMO™ BASINS AND WORKTOPS  
WITH WATER TEMPERATURE OVER 60°C.**

All SMO™ bowl designs are priced the same. Choose the style that you require, note the code and calculate the price according to the length on p.25

## SEMI-COUNTERTOP BASIN - To be used with standard 33cm deep basin unit BU33 or BUT33.

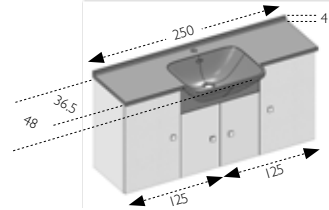

Maximum projection from bowl centre : 125cm  
Maximum length : 250cm  
Minimum size : 51cm

Without upstand  
With mini upstand

Worktop depth (cm)	Max. bowl projection (cm)	Code
36.5	48	<b>ZBASR36S + LENGTH</b>
		<b>ZBASR36R + LENGTH</b>

Bowl W 45.7 x D 35.9 x H 13 - Minimum 50cm width basin unit.

## SEMI-COUNTERTOP REDUCED DEPTH BASIN - To be used with standard 20cm deep basin unit BU20.

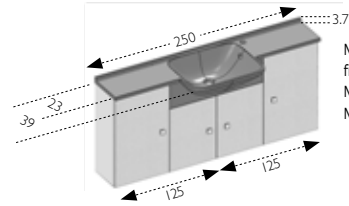

Maximum projection from bowl centre : 125cm  
Maximum length : 250cm  
Minimum size : 61cm

Only available with mini upstand

Worktop depth (cm)	Max. bowl projection (cm)	Code
23	39.1	<b>ZBASR23R+LENGTH</b>

Bowl W 45.7 x D 35.6 x H 13 - Minimum 60cm width basin unit. Tap hole only possible on right.

## ROUNDED FRONT INSET OVAL BASIN - To be used with rounded basin unit BA70.

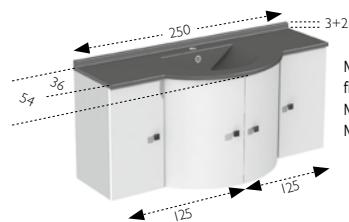

Maximum projection from bowl centre : 125cm  
Maximum length : 250cm  
Minimum size : 70.3cm

Only available with mini upstand

Worktop depth (cm)	Max. bowl projection (cm)	Code
36	54	<b>ZNBA70R+LENGTH</b>

Bowl W 44.5 x D 34.5 x H 12

## 55 ROUNDED FRONT REDUCED DEPTH INSET BASIN - To be used with 55cm reduced depth rounded basin unit BA2055.

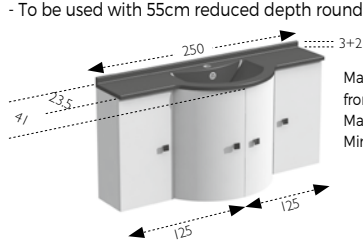

Maximum projection from bowl centre : 125cm  
Maximum length : 250cm  
Minimum size : 57cm

Only available with mini upstand

Worktop depth (cm)	Max. bowl projection (cm)	Code
23.5	41	<b>ZROUND5523R + LENGTH</b>

Bowl W 45 x D 24.5 x H 12

## 70 ROUNDED FRONT REDUCED DEPTH INSET BASIN - To be used with 70cm reduced depth rounded basin unit BA2070.

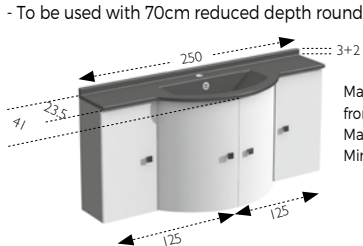

Maximum projection from bowl centre : 125cm  
Maximum length : 250cm  
Minimum size : 70.5cm

Only available with mini upstand

Worktop depth (cm)	Max. bowl projection (cm)	Code
23.5	41	<b>ZROUND23R+LENGTH</b>

Bowl W 54.5 x D 25 x H 13

## INLINE BASIN - Only suitable for a minimum 60cm width basin unit. 10L Basin Capacity

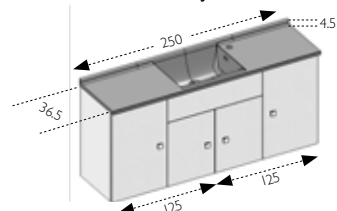

Maximum projection from bowl centre : 125cm  
Maximum length : 250cm  
Minimum size : 61cm

Only available with mini upstand

Worktop depth (cm)	Max. bowl projection (cm)	Code
36.5	36.5	<b>ZINLINE36R+LENGTH</b>

Bowl W 40.5 x D 31.9 x H 13 - Minimum 60cm width basin unit. Supplied with one RH tap hole as standard. can be supplied no tap hole on request.



All SMO™ bowl designs are priced the same. Choose the style that you require, note the code and calculate the price according to the length on p.25

## 90 OFFSET BASIN (RH shown) - To be used with 90cm wide offset basin unit ISE090.

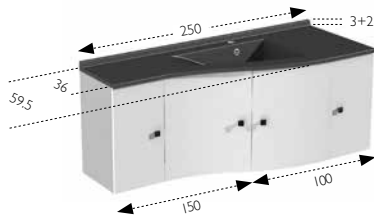

Maximum projection from bowl centre :  
150cm on reduced depth side,  
100cm on full depth side  
Maximum length : 250cm  
Minimum size : 91cm

Only available with mini upstand

	Worktop depth (cm)	Max. bowl projection (cm)	Code
LH	59.5/36	60	<b>ZNISE090GR+LENGTH</b>
RH	36/59.5	60	<b>ZNISE090DR+LENGTH</b>

Bowl W 65 x D 38 x H 12

## 90 OFFSET REDUCED DEPTH BASIN (RH shown) - To be used with 90cm wide reduced depth offset basin unit ISE02090.

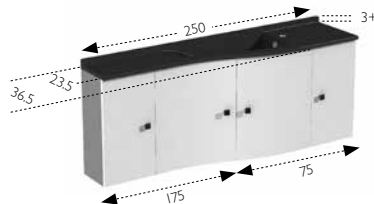

Maximum projection from bowl centre :  
175cm on reduced depth side,  
75cm on full depth side  
Maximum length : 250cm  
Minimum size : 91cm

Only available with mini upstand

	Worktop depth (cm)	Max. bowl projection (cm)	Code
LH	36.5/23.5	36.5	<b>ZISE02390GR + LENGTH</b>
RH	23.5/36.5	36.5	<b>ZISE02390DR + LENGTH</b>

Bowl W 66 x D 27 x H 10

## 60 OFFSET BASIN (RH shown) - To be used with 60cm offset basin unit DBA60.



Maximum projection from bowl centre :  
160cm on reduced depth side,  
90cm on full depth side  
Maximum length : 250cm  
Minimum size : 60.3cm

Only available with mini upstand

	Worktop depth (cm)	Max. bowl projection (cm)	Code
LH	59.5/36	59.5	<b>ZNDBA60GR + LENGTH</b>
RH	36/59.5	59.5	<b>ZNDBA60DR + LENGTH</b>

Bowl W 43.5 x D 36 x H 12

## 60 OFFSET REDUCED DEPTH BASIN (RH shown) - To be used with 60cm wide reduced depth offset basin unit DBA2060.

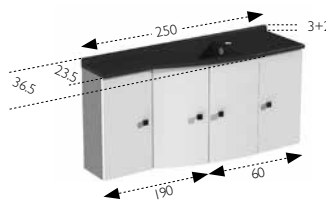

Maximum projection from bowl centre :  
190cm on reduced depth side,  
60cm on full depth side  
Maximum length : 250cm  
Minimum size : 60.5cm

Only available with mini upstand

	Worktop depth (cm)	Max. bowl projection (cm)	Code
LH	36.5/23.5	36.5	<b>ZDBA2360GR + LENGTH</b>
RH	23.5/36.5	36.5	<b>ZDBA2360DR + LENGTH</b>

Bowl W 43 x D 28.5 x H 10

## INSET 50CM DEPTH BASIN - To be used with 50cm deep basin units BV5647 or BVC5647.

Choose Dolce style (40 or 55 wide) or Square Bowl



Maximum length : 250cm  
Minimum size : 61.1cm  
Bowl can be placed anywhere within its length

Without upstand  
With mini upstand

	Worktop depth (cm)	Max. bowl projection (cm)	Code
Without upstand	50	50	<b>ZSV50 + LENGTH</b>
With mini upstand	50	50	<b>ZSVR50 + LENGTH</b>

ⓘ Dolce 55cm bowl requires minimum 70cm basin unit.

## INSET 60CM DEPTH BASIN - To be used with 60cm deep basin units BFD56 or BVC5656.

Choose Dolce style (40 or 55 wide) or Square Bowl



Maximum length : 250cm  
Minimum size : 61.1cm  
Bowl can be placed anywhere within its length

Without upstand  
With tall upstand

	Worktop depth (cm)	Max. bowl projection (cm)	Code
Without upstand	60	60	<b>ZSV + LENGTH</b>
With tall upstand	60	60	<b>ZSVR + LENGTH</b>

ⓘ Dolce 55cm bowl requires minimum 70cm basin unit.

# SOLID SURFACE WORKTOPS

**staron**<sup>®</sup>  
Solid Surfaces

## 12MM STARON<sup>®</sup> WORKTOPS

Staron countertops are a popular choice across the globe. They are used in hospitals, doctors / dentist surgeries, restaurants and food preparation areas.

Staron worksurfaces are 100% non-porous which makes them highly suitable for bathrooms, where hygiene is of the utmost importance. As it is non-porous, it means that bacteria and moulds are unable to grow on it, or to penetrate the surface.

This property means that it is also highly resistant to stains. Spills which would cause staining on many countertops - marble, granite and quartz, for instance., although it goes without saying that any spills should be wiped off as soon as they are seen. All that is needed with Staron is a wipe with a damp cloth.

Also used for shelves and window sills etc.



Code	Depth (cm)	Price per 10cm
<b>STARTAB23</b>	23.5	£36
<b>STARTAB36</b>	35.5	£45
<b>STARTAB50</b>	50	£48
<b>STARTAB60</b>	59	£48

- ! For curved front worktops for ISEO and BA units use the deepest worktop and add the curved cut below
- ! Supplied with back support bracket for basin units



SOLID SURFACE  
WORKTOP DEPTH CUT

**STARDECPROF**  
£195



SOLID SURFACE  
EPANEL CURVE CUT

**STARDECCUR**  
£195



SOLID SURFACE  
ANGLED DEPTH CUT

**STARDECPS**  
£195



SOLID SURFACE  
ROUNDED DEPTH CUT

**STARDECRC**  
£195



SOLID SURFACE  
ROUNDED END CUT

**STARDECBAT**  
£195

# BATH PANELS

## STANDARD BATH PANELS

with adjustable plinth - 58cm maximum height



12 months Guarantee

Code	Width (cm)	Price
<b>KOMBATH170</b>	170	£195
<b>KOMBATH180</b>	180	£195
<b>KOMBATH70</b>	70	£99
<b>KOMBATH75</b>	75	£99
<b>KOMBATH80</b>	80	£99

## HIGH BATH PANEL

with adjustable plinth - 68cm maximum height



12 months Guarantee

Code	Width (cm)	Price
<b>HIBATH170</b>	170	£195
<b>HIBATH180</b>	180	£195
<b>HIBATH70</b>	70	£99
<b>HIBATH75</b>	75	£99
<b>HIBATH80</b>	80	£99

## PROVENCE BATH PANELS

with adjustable plinth - 58cm maximum height

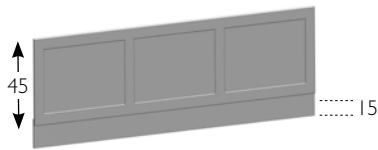

12 months Guarantee

Code	Width (cm)	Price
<b>PROVBATH170</b>	170	£195
<b>PROVBATH180</b>	180	£195
<b>PROVBATH70</b>	70	£99
<b>PROVBATH75</b>	75	£99
<b>PROVBATH80</b>	80	£99

## PROVENCE OFFSET FRONT PANELS

with adjustable plinth - 58cm maximum height

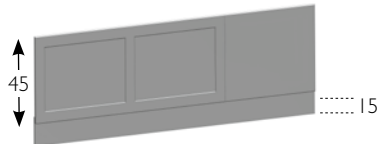

12 months Guarantee

Code	Width (cm)	Price
<b>PROVOFFBATH170</b>	170	£195
<b>PROVOFFBATH180</b>	180	£195

ⓘ Bath filler unit required

## STANDARD BATH FILLER UNIT

5 cm wide

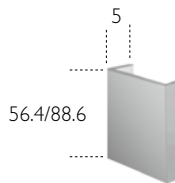

Code	Height (cm)	Depth (cm)	Price
<b>BATHFILL5656</b>	56.4	56.4	£159
<b>BATHFILL5633</b>	56.4	33	£159
<b>BATHFILL5620</b>	56.4	20	£159
<b>BATHFILL8833</b>	88.6	33	£185
<b>BATHFILL8820</b>	88.6	20	£185

## TALL BATH FILLER UNIT

5 cm wide



Code	Height (cm)	Depth (cm)	Price
<b>BATHFILL20120</b>	210	20	£224
<b>BATHFILL20133</b>	210	33	£224
<b>BATHFILL20156</b>	210	56	£224

# LED MIRRORS

## LED-LIT MIRRORS

LED strip lights (6000K) on each side fitted with SELV switch and antimist. May be fitted vertical or horizontal.

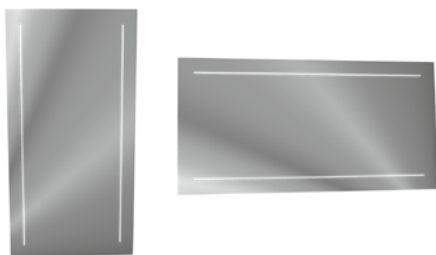

Code	Width (cm)	Height (cm)	Price
<b>MILDH45UK</b>	45	45	£695
<b>MILDH70UK</b>	70	45	£835
<b>MILDH90UK</b>	90	45	£865
<b>MILDH105UK</b>	105	45	£875
<b>MILDH120UK</b>	120	45	£895
<b>MILDH140UK</b>	140	45	£925

## ROUND MIRRORS

Peripheral LED lighting (5700K) with touch switch and antimist. \*KMIROND120 does not include antimist



	Code	Width (cm)	Height (cm)	Price
Plain	<b>KMIROND75</b>	75	75	£475
Etched Border	<b>KMIRONDEP75</b>	75	75	£475
Plain	<b>KMIROND100</b>	100	100	£785
Plain	<b>KMIROND120*</b> (no antimist)	120	120	£740

## ESQUIRE LED LIT MIRRORS

Peripheral LED lighting (4200K) No switch, to be connected to bathroom lighting circuit. Can be fitted vertically or horizontally.



Code	Width (cm)	Height (cm)	Price
<b>SQUARE60</b>	60	55	£275
<b>SQUARE90</b>	90	55	£295
<b>SQUARE120</b>	120	55	£375

## OVAL LED MIRROR

Peripheral LED lighting (4000K) No switch, to be connected to bathroom lighting circuit. Can be fitted vertically or horizontally.

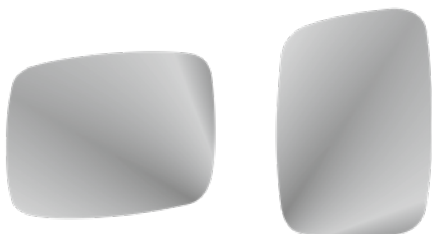

Code	Width (cm)	Height (cm)	Price
<b>MIRADIUS55</b>	55	70	£365
<b>MIRADIUS90</b>	90	70	£465
<b>MIRADIUS120</b>	120	70	£565

## MIRROR WITH LIGHT

MIROVOIDE mirror supplied with ECOV20 wall light No switch, to be connected to bathroom lighting circuit. ECOV20: Height: 5.6 cm, 6 W 392 lm, 5700°K, IP 44 class II

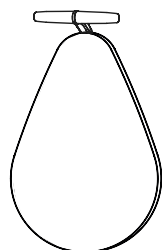

Code	Width (cm)	Height (cm)	Price
<b>GEMMIOV</b>	47	70	£325

# MIRRORS

## MOOD MIRRORS

Can be fitted vertically or horizontally.

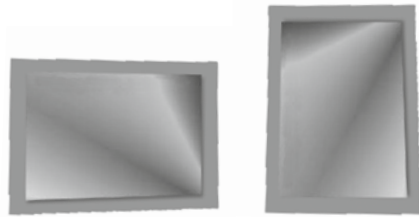

Code	Width (cm)	Height (cm)	Price
<b>MITB40</b>	40	80	£175
<b>MITB55</b>	55	80	£195

## MIRROR WITH MATT BLACK METAL FRAME

Wall Mounted Mirror

Delivered with removable decorative tube

Diameter 16mm Length max 55cm, min 35cm



\* Rectangular with shelf  
W 31.5 cm Prof. 10 cm.

	Code	Width (cm)	Height (cm)	Price
*Rectangular	<b>MIFORMH</b>	50	100	£625
Round	<b>MIFORMR</b>	70	70	£525

# LIGHTS

Individually ordered wastes, handles and ancillary items will incur a £10 P & P charge.

### SANCTUARY LIGHT



**ECSAN**  
Chrome LED (6000K)  
H4.1 x W45 cm  
£ 179

⚠ Not suitable for installation  
with Mood Mirror

### PHANTOM LIGHT



**ECIPH**  
Chrome LED (6000K)  
H7 x W20 cm  
£ 159

### INDUSTRIAL LED LIGHT



**ECFILK**  
Matt black LED (3000K)  
H15 x W18 cm  
£ 225

### CONNEX LED LIGHT



**ECLCIRK**  
Chrome LED (5700K)  
H2 x W45 cm  
£ 125

### CLOUD LIGHT CHROME 30CM



**ECCLD**  
Chrome LED (6000K)  
H3.9 x W30 cm  
£ 149

### CLOUD LIGHT MATT BLACK 30CM



**ECCLDNO**  
Matt black LED (6000K)  
H3.9 x W30 cm  
£ 149

### CLOUD LIGHT CHROME 50CM



**ECCLD50**  
Chrome LED (6000K)  
H5 x W50 cm  
£ 179

### CLOUD LIGHT MATT BLACK 50CM



**ECCLD50NO**  
Matt black LED (6000K)  
H5 x W50 cm  
£ 179

⚠ These lights are unswitched to be wired and switched via bathroom lighting circuit

## BASIN UNIT TOP FASCIA

### FIXED FASCIAS FOR BASIN UNIT - WITHOUT PRE-CUT FOR BASIN

Code	Width (cm)	Height (cm)	Price Group 0	Price Group 1	Price Group 2
<b>FF50</b>	49.7	15.9	£115	£122	£127
<b>FF60</b>	59.7	15.9	£127	£134	£138
<b>FF70</b>	69.7	15.9	£138	£150	£150
<b>FF80</b>	79.7	15.9	£157	£161	£161

! No moulding on Provence door style

### FIXED FASCIAS FOR BASIN UNIT - PRE-CUT FOR STANDARD RESIN WORKTOP

Code	Width (cm)	Height (cm)	Price Group 0	Price Group 1	Price Group 2
<b>FF50SMOZBASR</b>	49.7	15.9	£115	£122	£127
<b>FF60SMOZBASR</b>	59.7	15.9	£127	£134	£138
<b>FF70SMOZBASR</b>	69.7	15.9	£138	£150	£150
<b>FF80SMOZBASR</b>	79.7	15.9	£157	£161	£161

! No moulding on Provence door style

## WC TOP FASCIA

### FOR ALL WC UNITS - UNDRILLED

Code	Width (cm)	Height (cm)	Price Group 0	Price Group 1	Price Group 2
<b>FF40</b>	39.7	15.9	£115	£122	£127
<b>FF50</b>	49.7	15.9	£115	£122	£127
<b>FF60</b>	59.7	15.9	£127	£134	£138
<b>FF70</b>	69.7	15.9	£138	£150	£150
<b>FF80</b>	79.7	15.9	£157	£161	£161

! No moulding on Provence door style

# FASCIAS

## WC BOTTOM FASCIA

### FOR STANDARD WC UNIT

Code	Width (cm)	Height (cm)	Price Group 0	Price Group 1	Price Group 2
<b>FACADEEBWC4040</b>	39.7	40	£138	£150	£161
<b>FACADEEBWC4050</b>	49.7	40	£157	£161	£180
<b>FACADEEBWC4060</b>	59.7	40	£261	£273	£278
<b>FACADEEBWC4070</b>	69.7	40	£347	£359	£366
<b>FACADEEBWC4080</b>	79.7	40	£347	£371	£389



### FOR WALL HUNG AND FLOOR MOUNTED WC UNITS

Code	Width (cm)	Height (cm)	Price Group 0	Price Group 1	Price Group 2
<b>FACADEEBWCWH6640</b>	39.7	66.6	£220	£238	£266
<b>FACADEEBWCWH6650</b>	49.7	66.6	£261	£273	£296
<b>FACADEEBWCWH6660</b>	59.7	66.6	£289	£301	£308
<b>FACADEEBWCWH6670</b>	69.7	66.6	£371	£394	£401
<b>FACADEEBWCWH6680</b>	79.7	66.6	£389	£401	£401

### FOR HI-LINE WC UNITS

Code	Width (cm)	Height (cm)	Price Group 0	Price Group 1	Price Group 2
<b>FACADE392WC</b>	39.7	52.8	£180	£192	£215
<b>FACADE393WC</b>	49.7	52.8	£208	£220	£238
<b>FACADE391WC</b>	59.7	52.8	£278	£289	£296
<b>FACADE394WC</b>	69.7	52.8	£359	£378	£382
<b>FACADE395WC</b>	79.7	52.8	£371	£389	£394

Individually ordered wastes, handles and ancillary items will incur a £10 P & P charge.

<p>SLIDE FASCIA CLIPS</p>  <p><b>CLIPSF8</b> For fixing fascias £10</p>	<p>PUSH FASCIA CLIPS</p>  <p><b>CLIPSFH</b> For fixing fascias £10</p>
--	---



SMO™ WORKTOPS  
see page **24-27**

BATH PANELS  
see page **29**

MIRRORS  
see page **30-31**

ANCILLARY ITEMS  
see page **36-37**

# FASCIAS

## NB

- Fascias are always 0.2-0.3cm smaller than the unit carcass to allow clearance for removal and/or door and drawer opening. (e.g. 59.7 fascia fits 60cm unit)

- For special sizes, take the price of the superior dimension + 15% (maxi 118x59.7cm)

## SPECIFICATIONS

All codes are for unhinged fascias, undrilled for handles

For hinged doors, add the following letter at the end of the code:

**L** for left-hand hinged

**R** for right hand hinged

**T** for drawer

2 hinges fitted to fascias up to 88.3cm

3 hinges fitted to fascias over 88.4cm

Please note the prices include hinge back plates: see below.

For special sizes, take the price of the superior dimension + 15% (maxi 118 x 59.7cm)

### HINGE BACK PLATE



- ① 2 supplied for fascias up to 88.3cm
- 3 supplied for fascias over 88.4cm

### BPLATE

Code	Width (cm)	Height (cm)	Price Group 0	Price Group 1	Price Group 2
FACADE01	14.7	13	£115	£122	£134
FACADE02	14.7	13.2	£115	£122	£134
FACADE03	14.7	15.9	£122	£122	£134
FACADE04	29.7	15.9	£122	£127	£138
FACADE05	34.7	15.9	£127	£134	£150
FACADE06	39.7	15.9	£134	£138	£161
FACADE07	44.7	15.9	£115	£115	£134
FACADE08	49.7	15.9	£115	£122	£127
FACADE09	59.7	15.9	£127	£134	£150
FACADE10	69.7	15.9	£138	£150	£150
FACADE11	79.7	15.9	£157	£161	£161
FACADE13	99.7	15.9	£185	£192	£196
FACADE14	29.7	20.6	£138	£157	£196
FACADE15	34.7	20.6	£150	£161	£203
FACADE16	39.7	20.6	£203	£215	£227
FACADE17	44.7	20.6	£215	£227	£238
FACADE18	49.7	20.6	£227	£231	£250
FACADE19	29.7	23.8	£168	£180	£220
FACADE190	14.7	23.8	£122	£127	£138
FACADE20	34.7	23.8	£192	£196	£203
FACADE21	39.7	23.8	£203	£215	£227
FACADE22	44.7	23.8	£203	£220	£227
FACADE23	49.7	23.8	£227	£231	£250
FACADE251	29.7	28	£203	£215	£227
FACADE252	34.7	28	£220	£220	£231
FACADE253	39.7	28	£220	£231	£250
FACADE255	59.7	28	£220	£231	£250
FACADE257	69.7	28	£289	£301	£319
FACADE259	89.7	28	£301	£319	£331
FACADE29	29.7	32	£220	£220	£231
FACADE30	34.7	32	£227	£227	£238
FACADE31	39.7	32	£227	£231	£254
FACADE32	44.7	32	£296	£301	£324
FACADE33	49.7	32	£308	£324	£347
FACADE227	24.7	40	£196	£215	£220
FACADE34	29.7	40	£215	£215	£227
FACADE35	34.7	40	£220	£220	£231
FACADE36	39.7	40	£220	£227	£250
FACADE37	44.7	40	£227	£227	£250
FACADE38	49.7	40	£227	£227	£250
FACADE381	69.7	40	£273	£278	£296
FACADE382	89.7	40	£301	£308	£336
FACADE383	119.7	40	£331	£347	£347
FACADE384	59.7	40	£331	£347	£347
FACADE44	29.7	52.8	£203	£220	£238
FACADE45	34.7	52.8	£220	£238	£261
FACADE46	39.7	52.8	£231	£254	£273
FACADE47	44.7	52.8	£238	£261	£273
FACADE48	49.7	52.8	£250	£266	£289
FACADE91	19.7	56.1	£215	£215	£220
FACADE49	29.7	56.1	£220	£220	£227
FACADE50	34.7	56.1	£220	£220	£238
FACADE51	39.7	56.1	£227	£227	£250
FACADE52	44.7	56.1	£231	£238	£250



# FASCIAS

Code	Width (cm)	Height (cm)	Price Group 0	Price Group 1	Price Group 2
FACADE53	49.7	56.1	£238	£250	£254
FACADE535	69.7	66.6	£371	£378	£394
FACADE536	79.7	66.6	£389	£401	£405
FACADE537	89.7	66.6	£401	£405	£417
FACADE54	29.7	68.9	£250	£266	£289
FACADE55	34.7	68.9	£266	£278	£308
FACADE56	39.7	68.9	£278	£296	£319
FACADE57	44.7	68.9	£289	£308	£331
FACADE58	49.7	68.9	£296	£319	£336
FACADE59	24.7	81	£273	£301	£319
FACADE60	29.7	81	£289	£319	£324
FACADE61	34.7	81	£308	£336	£347
FACADE62	39.7	81	£324	£359	£366
FACADE63	44.7	81	£324	£359	£371
FACADE64	49.7	81	£273	£296	£308
FACADE205	19.7	84.7	£308	£308	£331
FACADE65	24.7	84.7	£289	£301	£324
FACADE66	29.7	84.7	£301	£319	£331
FACADE67	34.7	84.7	£308	£324	£347
FACADE68	39.7	84.7	£319	£331	£347
FACADE69	44.7	84.7	£324	£347	£359
FACADE70	49.7	84.7	£324	£347	£359
FACADE147	59.7	84.7	£336	£359	£371
FACADE701	29.7	87	£308	£324	£347
FACADE702	34.7	87	£319	£331	£347
FACADE703	39.7	87	£324	£347	£359
FACADE704	49.7	87	£331	£347	£366
FACADE705	59.7	87	£347	£359	£371
FACADE71	29.7	88.3	£319	£331	£347
FACADE72	34.7	88.3	£319	£336	£347
FACADE73	39.7	88.3	£324	£347	£347
FACADE148	49.7	88.3	£331	£347	£366
FACADE149	59.7	88.3	£347	£347	£371
FACADE731	29.7	93.4	£319	£336	£347
FACADE732	34.7	93.4	£324	£347	£359
FACADE733	39.7	93.4	£331	£347	£359
FACADE734	49.7	93.4	£336	£359	£366
FACADE735	59.7	93.4	£347	£366	£371
FACADE74	29.7	98.5	£324	£347	£347
FACADE75	34.7	98.5	£324	£347	£359
FACADE76	39.7	98.5	£331	£347	£366
FACADE77	29.7	101.8	£324	£347	£347
FACADE78	34.7	101.8	£324	£347	£359
FACADE79	39.7	101.8	£331	£347	£366
FACADE150	49.7	101.8	£347	£359	£371
FACADE151	59.7	101.8	£347	£366	£378
FACADE80	29.7	114.6	£324	£347	£347
FACADE81	34.7	114.6	£331	£347	£359
FACADE82	39.7	114.6	£331	£347	£366
FACADE83	29.7	118	£324	£347	£347
FACADE84	34.7	118	£331	£347	£359
FACADE85	39.7	118	£331	£347	£366
FACADE86	44.7	118	£347	£359	£371
FACADE87	49.7	118	£347	£366	£378
FACADE152	59.7	118	£359	£371	£389

## NB

- Fascias are always 0.2-0.3cm smaller than the unit carcass to allow clearance for removal and/or door and drawer opening. (e.g. 59.7 fascia fits 60cm unit)

- For special sizes, take the price of the superior dimension + 15% (maxi 118x59.7cm)

## SPECIFICATIONS

All codes are for unhinged fascias, undrilled for handles

For hinged doors, add the following letter at the end of the code:

**L** for left-hand hinged

**R** for right hand hinged

**T** for drawer

2 hinges fitted to fascias up to 88.3cm

3 hinges fitted to fascias over 88.4cm

Please note the prices include hinge back plates: see below.

For special sizes, take the price of the superior dimension + 15% (maxi 118 x 59.7cm)

### HINGE BACK PLATE



- ① 2 supplied for fascias up to 88.3cm
- 3 supplied for fascias over 88.4cm

### BPLATE

# ANCILLARY ITEMS

LAMINATE/FOIL WORKTOP IS **INCLUDED** WITH ALL FITTED BASE UNITS.  
USE THE PRICING BELOW FOR EXTRA LENGTHS AND SPARES ONLY.

## EXTRA BULL NOSE 30MM WORKTOP

without upstand



Code	Depth (cm)		Price
<b>PLPD2303</b>	23.5	per 10cm	£19
<b>PLPD3603</b>	36.5	per 10cm	£19
<b>PLPD03</b>	60	per 10cm	£19

## EXTRA SQUARE EDGED 30MM WORKTOP

without upstand



Code	Depth (cm)		Price
<b>PLSD2303</b>	23.5	per 10cm	£19
<b>PLSD3603</b>	36.5	per 10cm	£19
<b>PLSD03</b>	60	per 10cm	£19

Available in Laminate or Foil.

## EXTRA BULL NOSE 30MM WORKTOP

with 9cm upstand



Code	Depth (cm)		Price
<b>PLPDD01223</b>	23.5	per 10cm	£29
<b>PLPDD01236</b>	36.5	per 10cm	£29
<b>PLPDD012</b>	60	per 10cm	£29

## EXTRA SQUARE EDGED 30MM WORKTOP

with 9cm upstand



Code	Depth (cm)		Price
<b>PLSDD01223</b>	23.5	per 10cm	£29
<b>PLSDD01236</b>	36.5	per 10cm	£29
<b>PLSDD012</b>	60	per 10cm	£29

## EXTRA 1/2 ROUND EDGED 18MM SHELF



Laminate colours only

Code	Depth (cm)		Price
<b>TOPS</b>	10-60cm (specify)	per 10cm	£28

## staron® SOLID SURFACE 12MM WORKTOPS & SHELVES



Code	Depth (cm)		Price
<b>STARTAB23</b>	23.5	per 10cm	£36
<b>STARTAB36</b>	35.5	per 10cm	£45
<b>STARTAB50</b>	50	per 10cm	£48
<b>STARTAB60</b>	59	per 10cm	£48

Also used for Shelves and Window Sills etc.

# ANCILLARY ITEMS

## LAMINATE SHEET

1-2mm thick sheet material



Code	Price
<b>STRAT</b>	per sq. meter (£49 min per piece) £199

## MELAMINE BOARD

16mm thick fully PVC edged sheet material both sides colour



minimum 15.5cm x 15.5 cm

Code	Price
<b>PAMEL16</b>	per sq. meter (£50 min per piece) £134

## LAMINATED OR FOIL WRAPPED BOARD

16mm thick fully edged sheet material one side colour, one side white



minimum 15.5 x 15.5cm

Code	Price
<b>PASTR1</b>	per sq. meter (£99 min per piece) £399

## LAMINATED OR FOIL WRAPPED BOARD

16mm thick fully edged sheet material two sided colour



minimum 15.5 x 15.5cm

Code	Price
<b>PASTR4</b>	per sq. meter (£99 min per piece) £399

## LAMINATED OR FOIL WRAPPED BOARD

16mm thick fully edged sheet material one side, limited colours on the reverse side.



minimum 15.5 x 15.5cm

Code	Price
<b>FACADENPNF</b>	per sq. meter (£99 min per piece) £399

## EDGING

PVC edging tape for hot glue or contact adhesive bonding

❗ Not possible in all colours - Check availability

Code	Width (mm)	Price
<b>EDGING24</b>	24	per meter £34
<b>EDGING34</b>	34	per meter £34

## EXTRA PLINTH

with bonded rubber bottom seal



Code	Width (mm)	Price
<b>PLINTH27</b>	27	per 10cm £17
<b>PLINTH15</b>	15	per 10cm £17

## ACCESSORIES

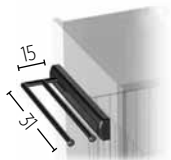

Sliding chrome towel rail, for shallow units.

Code	Price
<b>PPSCH33</b>	£178

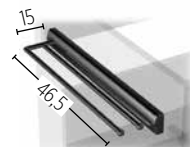

Sliding chrome towel rail, for deep cabinets.

Code	Price
<b>PPSCH56</b>	£199



Wooden cosmetics storage

Code	Price
<b>RCC160</b>	£99

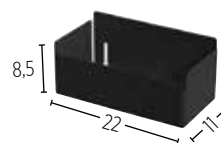

Metal tray

Code	Price
<b>BAC22NO</b>	£39

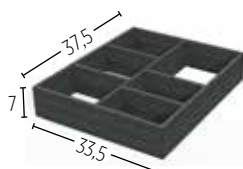

Wooden cosmetics storage

Code	Price
<b>RCC3733</b>	£129

## CORNER SITUATIONS

STRAIGHT CORNER UNIT with 330mm return.

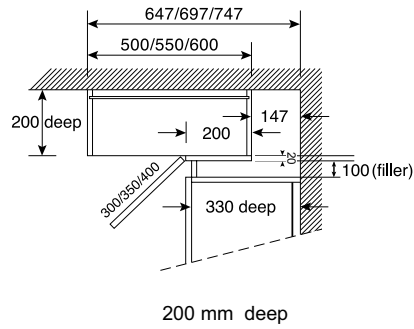
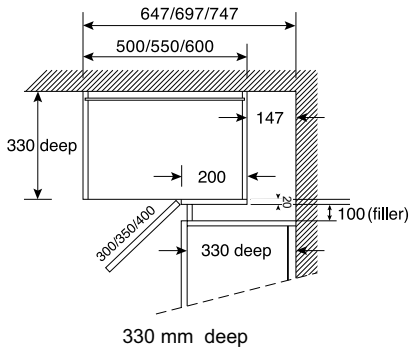

❗ For L Shaped Jointed Worktops, basin side is always the longer worktop into the corner.

STRAIGHT CORNER UNIT with 200mm return.

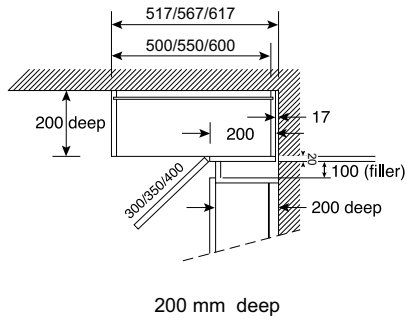
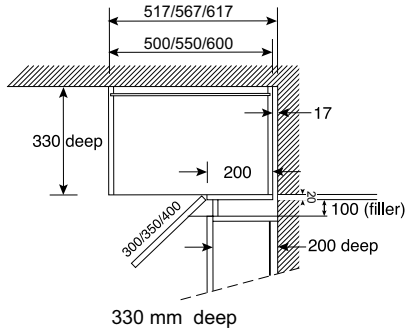

## CORNER FILLER

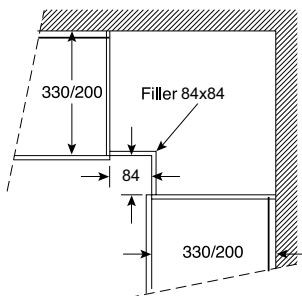

## OFFSET BATH FRONT PANEL

OVERHEAD VIEW

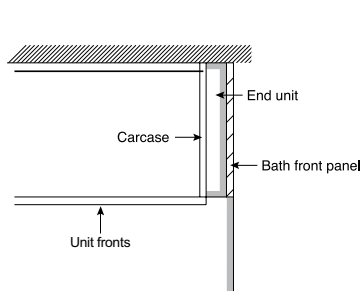

PERSPECTIVE

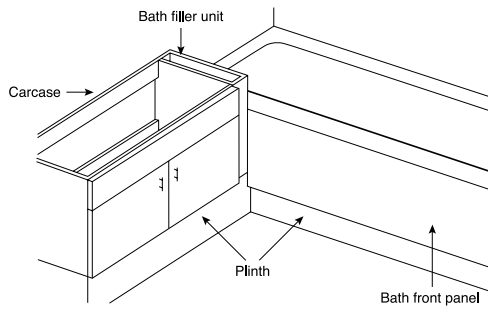

## EXAMPLES OF FITTED FURNITURE DIMENSIONS

STANDARD

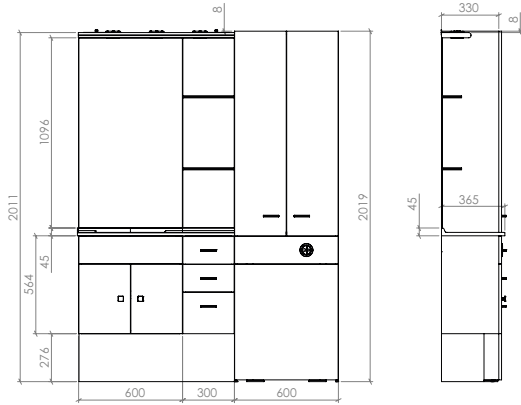

HI-LINE

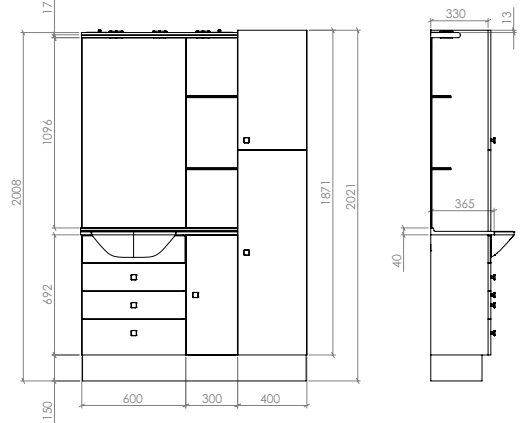

## FIRST FIX PLUMBING AND FIXING DIMENSIONS

FITTED RANGE (in mm)

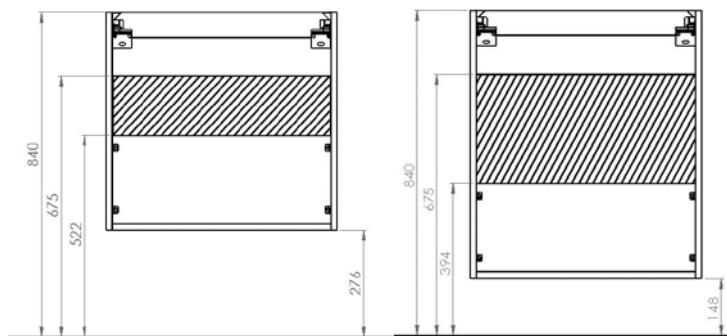

FIXING BRACKET DETAIL (in mm)

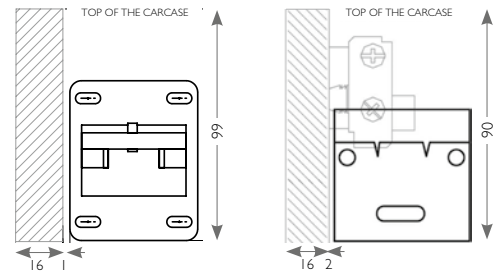

# DOOR STYLE

## MELAMINE DOOR STYLE



**NATIVE**  
Price Group 0  
SQUARE EDGED

## LAMINATE DOOR STYLE



**LAGOON**  
Price Group 1  
SQUARE EDGED

## FOIL DOOR STYLE



**KARLA**  
Price Group 1  
SQUARE EDGED



**PROVENCE**  
Price Group 2  
COUNTRY SHAKER STYLE

## FITTED HANDLES

Each Fitted unit includes Fitted handles. Additional Fitted handles are £ 28 each. The position shown is indicative, but may be different according to the door style or units chosen. Check with the sales office for exact orientation of handles on each unit or order undrilled and fix to clients specification during installation.



**P295**  
GROOVED  
BUTTON  
MATT BLACK



**P296**  
GROOVED  
BUTTON  
ALUMINIUM



**P297**  
GROOVED  
BUTTON  
ANTIQUE GOLD



**P039**  
WAVE  
CHROME



**P067**  
TOULON  
NICKEL



**P068**  
RETRO  
CHROME



**P070**  
CRYSTAL  
CHROME



**P037**  
LUNA  
CHROME  
(HORIZONTAL)



**P066**  
VALENCE  
CHROME

# HANDLES



**P027**  
LONG CRYSTAL BAR  
CHROME  
(HORIZONTAL)



**P035**  
LOOP  
CHROME  
(HORIZONTAL)



**P053**  
BENT BAR  
CHROME  
(HORIZONTAL)



**P055**  
RIDGE  
(HORIZONTAL)



**P090**  
CURVE HANDLES  
CHROME



**P091**  
CURVE HANDLES  
MATT BLACK



**P092**  
CURVE HANDLES  
GOLD



**P093**  
CURVE HANDLES  
COPPER



**P094**  
CURVE HANDLES  
PLATINUM



**P271**  
SUMIKO CHROME  
(HORIZONTAL)



**P273**  
SUMIKO MATT BLACK  
(HORIZONTAL)



**P275**  
SUMIKO MATT GOLD  
(HORIZONTAL)



**P292**  
GROOVED BAR  
MATT BLACK  
(HORIZONTAL)



**P293**  
GROOVED BAR  
ALUMINIUM  
(HORIZONTAL)



**P294**  
GROOVED BAR  
ANTIQUÉ GOLD  
(HORIZONTAL)

Ambiance Bain furniture is manufactured from several different board and foil materials, which are sourced from varying eco friendly European suppliers. Whilst every effort is made to find materials with matching colour and grain patterns it is inevitable that there will be some shade and pattern differences between different materials advertised as the same colour. Wood grain pattern orientations may differ on niches, tall units, fillers, bath panels and plinths due to the dimensional limitations of the raw materials used. All doors, drawers and fascias are made independently. No grain patterns or designs continue from one fascia to another, in any direction, on any Ambiance Bain units. Curved laminate doors, fascias and some worktops will have a visible hand finished "joint line" where the 2 opposing sheets of laminate meet at the top and bottom edge. This is part of the normal manufacturing process. Every Ambiance Bain retailer has samples of all material finishes available for perusal and approval. Please ensure that you and your clients are happy with any and all colour, grain and shade matches prior to ordering any furniture.

# COLOURS & FINISHES

## MELAMINE DOOR & CARCASE COLOURS

\* GLOSS COLOURS

M410* Gloss White	M411 Matt White (Carcase only)	M730 Matt Black	M704 Cashmere	M775 Safari	M732 Terracotta	M441 Santal	M445 Matcha
M431 Olive	M705 Atoll	M707 Oslo	M765 Messina	M733 Nebraska	M793 Riga	M728 Orme	M737 Ebony

NOTE: Open units available in melamine colours only.

## FOIL DOOR, WORKTOP & TOPS COLOURS

F01* Gloss White	F50* Gloss Black	F70* Stardust	F09 Chamonix (Matt White)	F72 Pearl Grey	F89 Cashmere	F84 Safari	F86 Pompadour
F56 Matcha	F92 Forest Green	F65 Fjord	F64 Steel Blue	F91 Regal	F90 Titane	F88 Cachou	F94 Matt Black
F79 Deauville	F82 Cedar	F80 Maple	F97 Natural Oak	F58 Honey Oak	F35 Burano	F37 Inari	F47 Charcoal Oak
F32 Catania	F74 Mistral	F53 Vesuvio					

For the purpose of continual improvement, Ambiance Bain reserves the right to modify the characteristics of our products at any time without prior notice. Colours and images are within the constraints of the printing process and should not be relied upon for matching purposes. E&OE



# LAMINATE WORKTOP & TOPS COLOURS

410* Gloss White	441 Santal	431 Olive	705 Atoll	808* Gloss Grey Mist	430* Gloss Black*		
450 White Marble	454 Black Marble	446 Gold Marble	448 Terrazzo Greige	721 Bosco	765 Messina	793 Riga	737 Ebony

Curved laminate doors, fascias and some worktops will have a visible hand finished "joint line" where the 2 opposing sheets of laminate meet.

# SMO™ WORKTOPS & BASINS COLOURS

200* Gloss White	201 Matt White	315 Ivory Satin	317 Kaolin Satin	277 Safari	399 Nude	273 Pompadour	395 Aloe
393 Aqua	365 Fjord	377 Ice Grey	231 Polaris	233 Atlas			
314 Glacier Galaxy Satin	212* Artic Galaxy Gloss	267 Nougat Satin	226* Nougat Galaxy Gloss	206* Mulberry Galaxy Gloss	234* Blizzard Galaxy Gloss	218* Platinum Galaxy Gloss	214* Silver Galaxy Gloss
316 Pewter Galaxy Satin	258* Granite Galaxy Gloss	RAL** Classic 					

\*\* Modular SMO™ are supplied in Gloss White with one tap hole per bowl. Other standard finishes and undrilled options are available at the same price as well as up to 200 RAL colours with a supplementary charge. Check website for RAL colour chart.



# staron® SOLID SURFACE WORKTOP COLOURS

R010 Matt White	R143 Crema	R412 Snow Storm	R420 Gris	R423 Comet	R440 Sahara	R811 Pebble Ice
--------------------	---------------	--------------------	--------------	---------------	----------------	--------------------

Staron® worksurfaces are 100% non-porous which makes them highly suitable for bathrooms, where hygiene is of the utmost importance. As it is non-porous, it means that bacteria and moulds are unable to grow on it, or to penetrate the surface.

# FITTED FURNITURE FURNITURE



**AMBIANCE BAIN**  
15 Cranford Court - Hardwick Grange  
Woolston - Warrington - WA1 4RX  
TEL : 01925 852675  
sales@ambiancebain.com

[www.ambiancebain.co.uk](http://www.ambiancebain.co.uk)