

SHOWER



DANISH DESIGN // 2024 GB

ALL OVER WELLNESS

ALL OVER WELLNESS

DANSANI SHOWER

Dansani Match & XXL shower enclosures will meet your needs for a quality solution, in either large or small bathrooms.



MATCH

Create a shower solution that fits your bathroom perfectly, no matter its size and shape. You can easily find a combination from 6 different types of doors and fixed shower panels.

10
YEAR WARRANTY

XXL



«

XXL

Large, user-friendly sliding door solution with a functional design. Perfect for recessed showers, but can also be combined with fixed shower panels.



Elegant and timeless look featuring slim, rectangular profiles in satin or matt black finish.



Height of 200cm provides adequate protection, especially if the shower head is installed on the ceiling.



Easy cleaning and maintenance with EasyCare treatment on the inside.



6mm clear safety glass. Selected models also available with frosted glass.



Both standard and asymmetric solutions are achievable, to make optimal use of space.



Perfect installation on off-square walls and on uneven flooring through various adjustment options.



All models are reversible without having to adjust them or use tools.

DANSANI MATCH

06 INSPIRATION

26 DESIGNING A SMALL BATHROOM

28 PRICE LIST

34 PRODUCT INFORMATION

36 DIMENSIONS



COMBINE FOR AN ENCLOSURE

THE WAY YOU WANT IT

The Match shower series consists of 6 basic models along with the practical Tower storage unit, which can be combined to form the exact shower solution to suit your bathroom. All models are supplied with profiles in black or satin, and they are reversible, so you do not need to differentiate between a right or left-handed model.

All Match models except C and H, can be combined with the smart Tower unit. Tower avoids clutter in the shower area and integrates seamlessly with the panel or door for a complete solution.

All models are 200cm high.

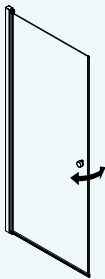

A - HINGED DOOR
70 / 80 / 90 / 100cm
Can be combined with Tower
Selected models also available with frosted glass



B - BIFOLD DOOR
70 / 80 / 90 / 100cm
Can be combined with Tower

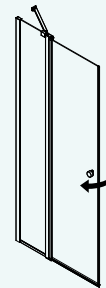

C - HINGED DOOR WITH IN-LINE PANEL
90 / 100cm



D - FIXED SHOWER PANEL
70 / 80 / 90 / 100 / 120 / 140cm
Can be combined with Tower
Selected models also available with frosted glass

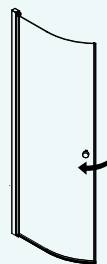

E - QUADRANT HINGED DOOR
80 / 90 / 100cm
Can be combined with Tower
Selected models also available with frosted glass

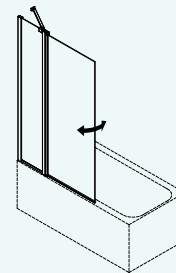

H - BATH PANEL WITH HINGED DOOR
100cm

TIPS FOR SMALL BATHROOMS

Match is the perfect choice for the smaller bathroom. Save space by pushing closed or folding away the doors when not in use. Or select a fixed shower enclosure that you can install fixtures right up to. Get more interior design inspiration for small bathrooms on p. 26.

»

HINGED DOOR AND FIXED SHOWER PANEL WITH TOWER

Classic combination of a fixed shower panel with the practical Tower storage unit with a hinged door. The practical solution here is that you can place furniture closer to the fixed shower panel, and use the space for a wider basin or an extra cabinet.

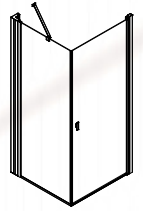
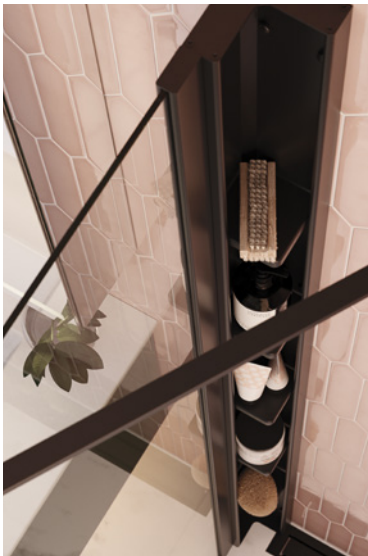
**90Cm A + D + 3 + Tower - Clear glass, matt black**

Hinged door 458.- Art. no. A91-03 / Fixed shower panel 458.- Art. no. D81-03 /
 Wall support 73.- Art. no. 1603508 / Tower 249.- Art. no. 1603577 /
 Flow handle 28.- Art. no. 1603641

SIMPLE & FLEXIBLE

When the enclosure is not in use the doors simply fold back into the corner freeing up valuable space in small rooms. Here the Tower storage unit has been added and the clever shelving system avoids clutter in the shower area.



NEWS:

The round handle now comes with an updated slimmer and more elegant profile. Included with all Match shower doors.



80cm A + A + Tower - Frosted glass, satin

Hinged door 553.- Art. no. A71-02 / Hinged door 553.- Art. no. A81-02 / Tower 249.- Art. no. 1600570

Accessories: Squeegee 34.- Art. no. 1600012

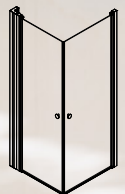

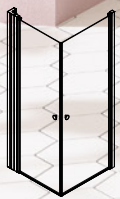

80cm A + A + Tower - Clear glass, matt black

Hinged door 458.- Art. no. A71-03 / Hinged door 458.- Art. no. A81-03 / Tower 249.- Art. no. 1603570

Accessories: Squeegee 34.- Art. no. 1600162

FURNITURE NEXT TO YOUR CORNER SHOWER

Make use of the space right next to your corner shower by choosing a hinged door with an in-line panel. The short fixed side panel allows furniture to be fitted close to the corner shower. When you are not using the shower, the doors can be pushed in, to give you more room.



90cm C + C - Clear glass, satin

Hinged door with in-line panel 458.- Art. no. C91-01 /
Hinged door with in-line panel 458.- Art. no. C91-01



A hinged door with in-line panel is supplied with a wall support as standard.

FIXED SHOWER PANEL AND BIFOLD DOOR

Very practical in a small bathroom, as the door opens inwards into the wet area. No water drips onto the floor outside – the perfect way to start or end the day.



80cm B + D + 4 - Clear glass, satin

Bifold door 553.- Art. no. B81-01 / Fixed shower panel 458.- Art. no. D81-01 /
Telescopic support rail 73.- Art. no. 1600503 / Flow handle 28.- Art. no. 1600641

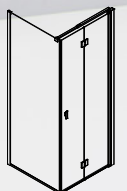



EVERYONE HATES BATTLING

WITH SCALE AND GRIME

All glass in the Dansani shower series is given a hard-wearing and environment-friendly EasyCare treatment, which prevents scale and grime buildup – even after being wiped 30,000 times. Simply wipe the glass over with a soft cloth after use, and your glass will look great for many years to come.

EasyCare is an environment-friendly German product, and certified by the independent SGS Institut Fresenius laboratory in accordance with OECD Guideline 2009.

GOODBYE TO SHOWER CURTAINS

This elegant bath screen means no more shower curtains, and it creates a far more spacious feeling in the room. The glass screen can fold in towards the shower, so it takes up the least possible space. Supplied with wall support.



100cm H - Clear glass, satin

Bath panel with hinged door 458.- Art. no. H100-01

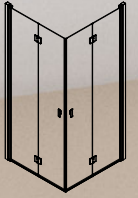

90cm B + B - Clear glass, matt black

Bifold door 553.- Art. no. B91-03 / Bifold door 553.- Art. no. B91-03 / Flow handle 28.- Art. no. 1603641

BIFOLD DOORS ARE SPACE SAVING

A smart solution where both doors can be folded in when you are not using the shower enclosure, so they take up as little space as possible in the room. The bifold door can also be combined with other doors and fixed shower panels.



On the inside of the bifold door the hinge is concealed and flush with the glass panel. Beautiful, practical design in action.

SOFT CURVES

Discover a shower solution that combines simplicity and style with two elegant quadrant doors. Our design allows the doors to open both inwards and outwards, creating extra space in the room when the shower enclosure is not in use.



The simple profiles conceal a rise and fall hinge, as well as an adjustment to ensure the doors work perfectly every time. A cover cap finishes the overall look.





90cm E + E + Tower - Clear glass, satin

Quadrant hinged door 458.- Art. no. E81-01 / Quadrant hinged door 458.- Art. no. E91-01 / Tower 249.- Art. no. 1600570



A SMART

RECESSED SHOWER

Choose from 3 different models according to your requirements, all of which of course have adjustment to suit the width of your opening. Adjustment is possible on both sides. For example, create extra width by adding wall profile 1 to the open side and at the same time adding an extension profile to the hinge side of the door. Get the full overview of the options and exact solutions on page 37.



90cm C + 1 - Clear glass, satin

Hinged door with in-line panel 458.- Art. no. C91-01 /
Wall profile for recess 188.- Art. no. 1600501 / Flow handle 28.- Art. no. 1600641



HINGED DOOR WITH IN-LINE PANEL

A smart recessed shower lets you place furniture closer to the shower while making optimal use of the space.



BIFOLD DOOR

A practical solution in a small bathroom, as the door opens inwards, and keeps the water in the shower area.



80cm B + 1 - Clear glass, satin

Bifold door 553.- Art. no. B81-01 / Wall profile for recess 188.- Art. no. 1600501



HINGED DOOR

For even the smallest of rooms using the Match hinged door provides an effective showering solution - even in the guest room. Simply fold the door against the wall when not in use, and open up when required.



80cm A - Clear glass, satin

Hinged door 458 - Art. no. A81-01 / Flow handle 28 - Art. no. 1600641

Accessories: Squeegee 34 - Art. no. 1600012

ANOTHER TYPE OF RECESS

A very elegant solution for a larger recess combining a door and fixed panel. The Tower storage unit also helps keep order in the shower area by adding practical storage space for shampoo, soap and whatever else you need in your bathroom.



100cm A + D + 3 + Tower - Clear glass, matt black

Hinged door 458.- Art. no. A101-03 /
Fixed shower panel 458.- Art. no. D101-03 /
Wall support 73.- Art. no. 1603508 /
Tower 249.- Art. no. 1603570 /
Flow handle 28.- Art. no. 1603641

Accessories: Squeegee 34.- Art. no. 1600162

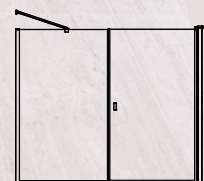

NEWS:

Purchase the new exclusive Flow metal handle to create a fantastic new look for your shower enclosure.

ELEGANT & COMPLETELY

FREE

A fixed shower panel is the perfect choice for those looking to create a minimalist solution. With different support options you can choose the solution that aesthetically appeals to you. For example, a telescopic rail is quick and simple to set up.

While the shorter support arm gives a cleaner look.

All solutions are equally sound.



Fixed shower panels are supplied with a floor profile which keeps the water inside, and a floor bracket that gives a light, floating effect. You choose which solution you want to use.





80cm D + 4 - Clear glass, matt black

Fixed shower panel 458.- Art. no. D81-03 / Telescopic support rail 73.- Art. no. 1603503

Accessories: Squeegee 34.- Art. no. 1600162

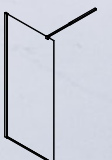

PLENTY OF SPACE WITH A **WALK-IN SHOWER**

For plenty of space and room to move around, this walk in wetroom enclosure is perfect providing an elegant solution with a very open minimalist look. With two telescopic support rails and a connector kit the solution is secure as well as attractive.



MIX & MATCH YOUR OWN SHOWER ENCLOSURE

You can mix & match all of the basic models – see an overview here.

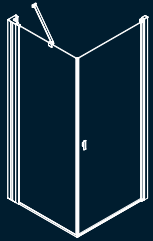

A + D + 3 + TOWER
See page 7



A + A + TOWER
See page 8 + 9

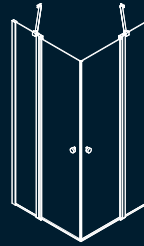

C + C
See page 10

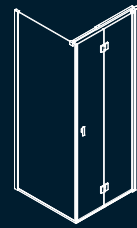

B + D + 4
See page 11

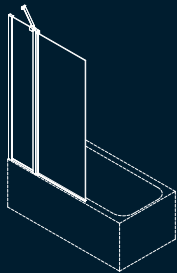

H
See page 13

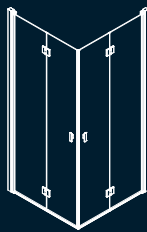

B + B
See page 14

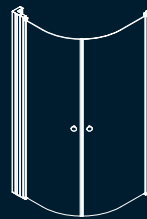

E + E + TOWER
See page 16



C + 1
See page 18



B + 1
See page 19



A
See page 20

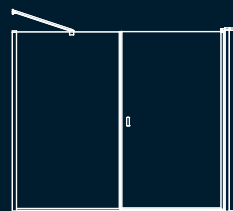

A + D + 3 + TOWER
See page 21

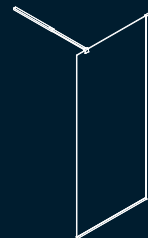

D + 4
See page 23

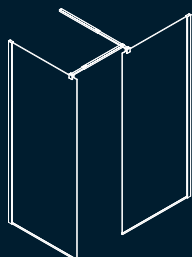

D + D + 4 (2 PCS.) + 5
See page 24



FURNISHING TIPS FOR SMALL BATHROOMS

Here you can find inspiration for making optimal use of space, if you have a very small or narrow bathroom. Many Match models allow you to place furniture closer to your shower solution, so there is room for a wider basin or an extra cabinet. The code under each solution refers to the door model and its width, and we have incorporated the Tower storage unit where possible - it is really important to be organised when space is limited.

120 x 160 CM

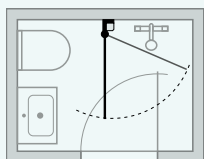

A91 + Tower

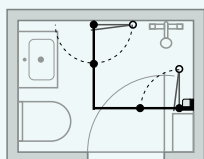

B81 + B81 + Tower

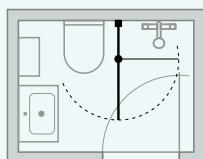

C91

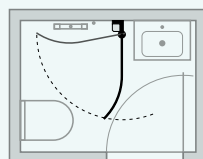

E81 + Tower

120 x 180 CM

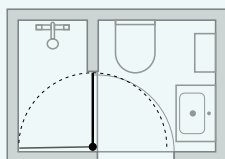

A71

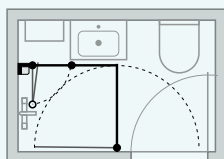

B91 + A81 + Tower

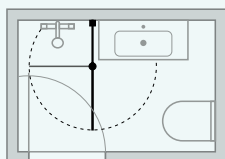

C101

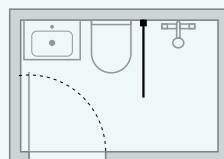

D71

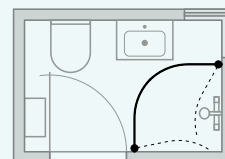

E81 + E81

150 x 200 CM

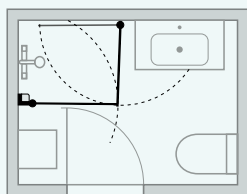

A81 + Tower + A91

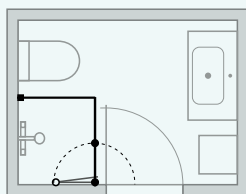

B81 + D71

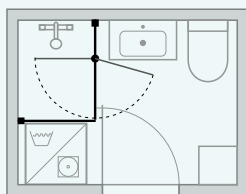

C91 + D71

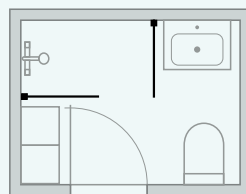

D71 + D71

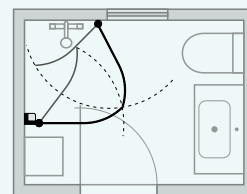

E81 + Tower + E81

RECESS 90CM

220 x 150 CM

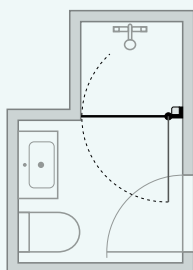

A91 + Tower

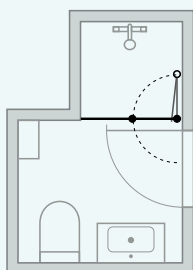

B91

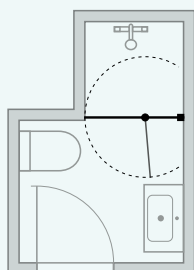

C91

MATCH ADJUSTABLE PIVOT HINGE - PROBLEM SOLVER

It is also possible to install shower enclosures even when the shower doors don't line up or the walls are off square as shown in solution E81+E81. The pivot hinge can be adjusted so the doors then close to this position.

See fitting instructions.

ADD THE

FINAL TOUCHES

An exclusive range of accessories that make daily life with Dansani Match an even greater pleasure. Everything is thought out down to the tiniest detail and designed for optimal use.



SQUEEGEE IN SILICONE

Contemporary shower squeegee in a dark grey silicone. The slightly textured surface provides a firm grip. The squeegee comes with a practical hook that hangs on the edge of the glass.

Dark grey silicone

Art. no.: 1600162

34.-



MINIMALIST SQUEEGEE

Elegant chrome squeegee. The strict and simple design is adapted to Match. The squeegee can hang directly on the edge of the glass using the included silicone hook.

Chrome

Art. no.: 1600012

34.-

Replacement rubber

Art. no.: 1600017

10.-



ERGONOMIC SQUEEGEE

No more water drops that turn into unsightly limescale deposits. Smart shower squeegee that fits your hand well and hangs elegantly in the accompanying bracket.

Stainless steel

Art. no.: 2400346

34.-

Replacement rubber

Art. no.: 2400500

10.-



SHOWER CORNER

Smart stainless steel shelf. The shelf is built into the corner of the shower cubicle without the use of screws, but can also be retro fitted in an existing shower enclosure.

Chrome

Art. no.: 2400600

69.-

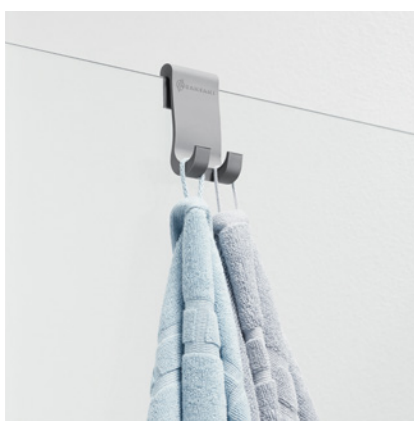

TOWEL HOOK IN SILICONE

Set with two hooks. The hook can hang on the edge of the glass, on the inside or outside, and is practical for towels, brushes, sponges etc.

Available in light or dark grey.

Light grey

Art. no.: 1600013

12.-

Dark grey

Art. no.: 1600163

12.-



MATCH BASE MODELS

A - HINGED DOOR

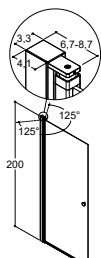

Material/Profile colour	70CM		80CM		90CM		100CM	
	Art. no.	Price £	Art. no.	Price £	Art. no.	Price £	Art. no.	Price £
Clear glass/Satin	A71-01	458.-	A81-01	458.-	A91-01	458.-	A101-01	458.-
Clear glass/Matt black	A71-03	458.-	A81-03	458.-	A91-03	458.-	A101-03	458.-
Frosted glass/Satin	A71-02	553.-	A81-02	553.-	A91-02	553.-	-	-
Height 200cm								
CORNER SOLUTION								
Set, min/max adjustment	69-71cm		79-81cm		89-91cm		99-101cm	
RECESS SOLUTION - SEE ACCESSORIES								
Door, min/max adjustment	67-69cm		77-79cm		87-89cm		97-99cm	
Door with seal 9, min/max adjustment	67,5-69,5cm		77,5-79,5cm		87,5-89,5cm		97,5-99,5cm	
Door with wall profile 8, min/max adjustment	69,5-71,5cm		79,5-81,5cm		89,5-91,5cm		99,5-101,5cm	
Door with wall profile 1, min/max adjustment	71,5-75,5cm		81,5-85,5cm		91,5-95,5cm		101,5-105,5cm	

General size guide – exact measurements can be found after product information.
On request satin profile models are available in sizes that are 2cm smaller

TOWER FOR MODEL A - HINGED DOOR

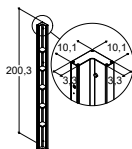

Colour	Art. no.	Price £	Art. no.	Price £	Art. no.	Price £	Art. no.	Price £
Satin	1600570	249.-	1600570	249.-	1600570	249.-	1600570	249.-
Matt black	1603570	249.-	1603570	249.-	1603570	249.-	1603570	249.-

Reversible storage unit with 5 removable shelves.
NOTE: simply choose your door 10cm smaller than your installation to create space for Tower.

B - BIFOLD DOOR (180°)

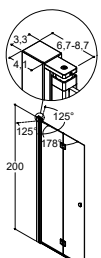

Material/Profile colour	70CM		80CM		90CM		100CM	
	Art. no.	Price £	Art. no.	Price £	Art. no.	Price £	Art. no.	Price £
Clear glass/Satin	B71-01	553.-	B81-01	553.-	B91-01	553.-	B101-01	553.-
Clear glass/Matt black	B71-03	553.-	B81-03	553.-	B91-03	553.-	B101-03	553.-
Height 200cm								
CORNER SOLUTION								
Set, min/max adjustment	69-71cm		79-81cm		89-91cm		99-101cm	
RECESS SOLUTION - SEE ACCESSORIES								
Door, min/max adjustment	67-69cm		77-79cm		87-89cm		97-99cm	
Door with seal 9, min/max adjustment	67,5-69,5cm		77,5-79,5cm		87,5-89,5cm		97,5-99,5cm	
Door with wall profile 8, min/max adjustment	69,5-71,5cm		79,5-81,5cm		89,5-91,5cm		99,5-101,5cm	
Door with wall profile 1, min/max adjustment	71,5-75,5cm		81,5-85,5cm		91,5-95,5cm		101,5-105,5cm	

General size guide – exact measurements can be found after product information.
On request satin profile models are available in sizes that are 2cm smaller

TOWER FOR MODEL B - BIFOLD DOOR

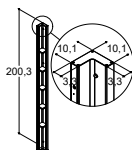

Colour	Art. no.	Price £	Art. no.	Price £	Art. no.	Price £	Art. no.	Price £
Satin	1600570	249.-	1600570	249.-	1600570	249.-	1600570	249.-
Matt black	1603570	249.-	1603570	249.-	1603570	249.-	1603570	249.-

Reversible storage unit with 5 removable shelves.
NOTE: simply choose your door 10cm smaller than your installation to create space for Tower.

C - HINGED DOOR (180°) WITH IN-LINE PANEL AND WALL SUPPORT

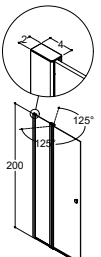

Material/Profile colour	70CM		80CM		90CM		100CM	
	Art. no.	Price £	Art. no.	Price £	Art. no.	Price £	Art. no.	Price £
Clear glass/Satin	-	-	-	-	C91-01	458.-	C101-01	458.-
Height 200cm								
CORNER SOLUTION								
Set, min/max adjustment	-		-		89-91cm		99-101cm	
RECESS SOLUTION - SEE ACCESSORIES								
Door, min/max adjustment	-		-		87-89cm		97-99cm	
Door with seal 9, min/max adjustment	-		-		87,5-89,5cm		97,5-99,5cm	
Door with wall profile 8, min/max adjustment	-		-		89,5-91,5cm		99,5-101,5cm	
Door with wall profile 1, min/max adjustment	-		-		91,5-95,5cm		101,5-105,5cm	

General size guide – exact measurements can be found after product information.
On request satin profile models are available in sizes that are 2cm smaller

ACCESSORIES

WALL PROFILE FOR RECESS 1

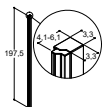

Description	Colour	Art. no.	Price £
Incl magnetic seal, adjustable	Satin	1600501	188.-
Incl magnetic seal, adjustable	Matt black	1603501	188.-

WALL PROFILE FOR RECESS 8

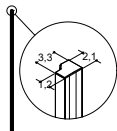

Description	Colour	Art. no.	Price £
Incl magnetic seal, slim profile, without adjustment	Satin	1600535	95.-
Incl magnetic seal, slim profile, without adjustment	Matt black	1603535	95.-

SEAL 9

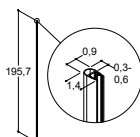

Description	Colour	Art. no.	Price £
D-profile PVC Sealing strip, without adjustment	Clear	1600639	24.-
D-profile PVC Sealing strip, without adjustment	Matt black	1603639	24.-



MODEL 1 – WALL PROFILE FOR RECESS FOR DOOR A, B AND C

Wall profile 1 for recess for use with door A, B and C and allows you to add 20mm. Combined with the hinge profile, which also can add 20mm, this gives it a total adjustment of 40mm in width.

If you need additional width you can add an extension profile - see accessories.

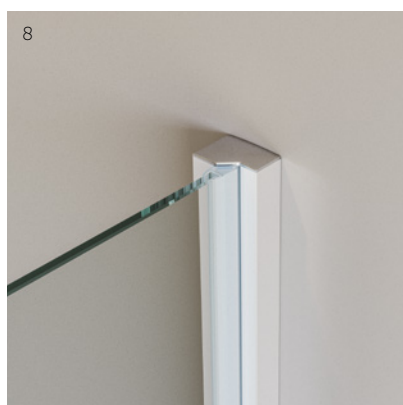

MODEL 8 – WALL PROFILE FOR RECESS FOR DOOR A, B AND C

Wall profile 8 for recess for use with door A, B and C. To be used where less adjustment is required for a neater look. Please note that using this profile means there is adjustment of only 20mm on the hinged door.

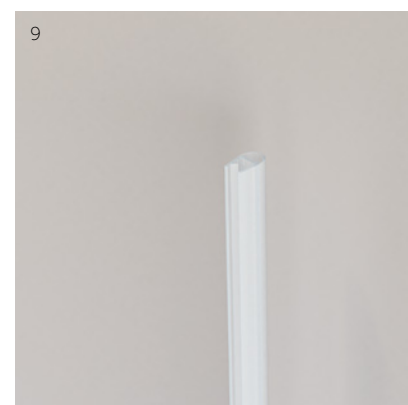

MODEL 9 – SEAL FOR DOOR A, B AND C





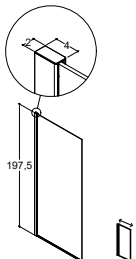

Seal 9 for use with door A, B or C. Where a wall profile is not required for a recess on the wall opposite the hinge, to give a light, elegant installation. Note that with the narrower installation, there is only 20mm adjustment on the door on the hinge side.



MATCH BASE MODELS

	70CM		80CM		90CM		100CM		120CM		140CM		
D- FIXED SHOWER PANEL WITH FLOOR PROFILE AND BRACKET													
NB: Always add support													
	Material/Profile colour	Art. no.	Price £	Art. no.	Price £	Art. no.	Price £	Art. no.	Price £	Art. no.	Price £	Art. no.	Price £
	Clear glass/Satin	D71-01	458.-	D81-01	458.-	D91-01	458.-	D101-01	458.-	D121-01	644.-	D141-01	644.-
	Clear glass/Matt black	D71-03	458.-	D81-03	458.-	D91-03	458.-	D101-03	458.-	-	-	-	-
	Frosted glass/Satin	D71-02	553.-	D81-02	553.-	D91-02	553.-	D101-02	553.-	-	-	-	-
	Height 197,5cm												
	Panel, min/max adjustment	67-69cm		77-79cm		87-89cm		97-99cm		117-119cm		137-139cm	
	General size guide – exact measurements can be found after product information. On request satin profile models are available in sizes that are 2cm smaller												

SUPPORT FOR FIXED SHOWER PANEL

	Colour	Art. no.	Price £	Art. no.	Price £	Art. no.	Price £	Art. no.	Price £	Art. no.	Price £	Art. no.	Price £
	2 Wall support 30cm (fixed shower panel)												
	Satin	1600502	73.-	-	-	-	-	-	-	-	-	-	-
	Matt black	1603502	73.-	-	-	-	-	-	-	-	-	-	-
	3 Wall support 60cm (fixed shower panel)												
	Satin	-	-	1600508	73.-	1600508	73.-	1600508	73.-	1600508	73.-	1600508	73.-
	Matt black	-	-	1603508	73.-	1603508	73.-	1603508	73.-	1603508	73.-	1603508	73.-
	4 Telescopic support rail 60-100cm (fixed shower panel)												
	Satin	1600503	73.-	1600503	73.-	1600503	73.-	1600503	73.-	1600503	73.-	1600503	73.-
	Matt black	1603503	73.-	1603503	73.-	1603503	73.-	1603503	73.-	1603503	73.-	1603503	73.-
	5 Connector kit til model D+D+4 (2 pcs.)												
	Satin	1600504	20.-	1600504	20.-	1600504	20.-	1600504	20.-	1600504	20.-	1600504	20.-
	Matt black	1603504	20.-	1603504	20.-	1603504	20.-	1603504	20.-	1603504	20.-	1603504	20.-
	6 Support rail 120cm for model D (fixed shower panel). Can be cut to suit if necessary												
	Satin	1600527	73.-	1600527	73.-	1600527	73.-	1600527	73.-	1600527	73.-	1600527	73.-
	Matt black	1603527	73.-	1603527	73.-	1603527	73.-	1603527	73.-	1603527	73.-	1603527	73.-
	7 Vertical ceiling support rail 100cm for model D (fixed shower panel). Can be cut to suit if necessary												
	Satin	1600528	73.-	1600528	73.-	1600528	73.-	1600528	73.-	1600528	73.-	1600528	73.-
	Matt black	1603528	73.-	1603528	73.-	1603528	73.-	1603528	73.-	1603528	73.-	1603528	73.-

TOWER FOR MODEL D - FIXED SHOWER PANEL

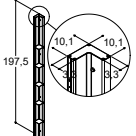
	Colour	Art. no.	Price £	Art. no.	Price £	Art. no.	Price £	Art. no.	Price £	Art. no.	Price £
	Satin	1600577	249.-	1600577	249.-	1600577	249.-	1600577	249.-	1600577	249.-
	Matt black	1603577	249.-	1603577	249.-	1603577	249.-	1603577	249.-	1603577	249.-
	Reversible storage unit with 5 removable shelves. NOTE: simply choose your door 10cm smaller than your installation to create space for Tower.										

SUPPORT FOR FIXED SHOWER PANEL

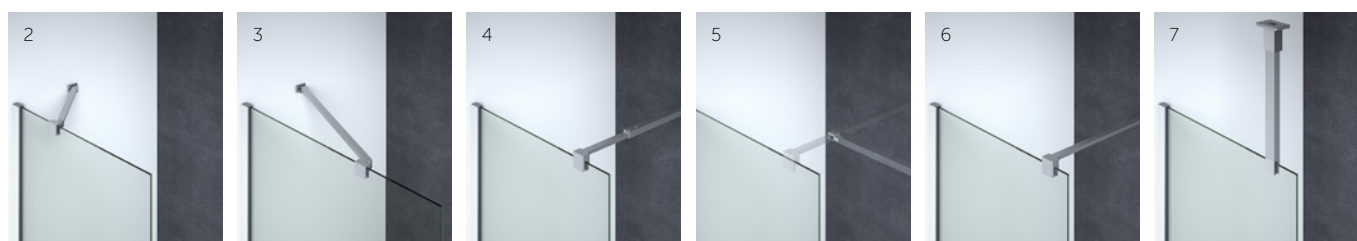

MATCH BASE MODELS

		80CM		90CM		100CM	
E - QUADRANT HINGED DOOR (180°)							
	Material/Profile colour	Art. no.	Price £	Art. no.	Price £	Art. no.	Price £
	Clear glass/Satin	E81-01	458.-	E91-01	458.-	E101-01	458.-
	Clear glass/Matt black	E81-03	458.-	E91-03	458.-	-	-
	Frosted glass/Satin	-	-	E91-02	553.-	-	-
	Height 200cm						
	CORNER SOLUTION						
	Set, min/max adjustment	79-81cm		89-91cm		99-101cm	
	INDIVIDUAL SCREEN						
	Door, min/max adjustment	62-64cm		72-74cm		82-84cm	
General size guide – exact measurements can be found after product information. On request satin profile models are available in sizes that are 2cm smaller							

		80CM		90CM		100CM	
TOWER FOR MODEL E - QUADRANT HINGED DOOR							
	Colour	Art. no.	Price £	Art. no.	Price £	Art. no.	Price £
	Satin	1600570	249.-	1600570	249.-	1600570	249.-
	Matt black	1603570	249.-	1603570	249.-	1603570	249.-
Reversible storage unit with 5 removable shelves. NOTE: simply choose your door 10cm smaller than your installation to create space for Tower.							

		80CM		90CM		100CM	
H - BATH PANEL WITH HINGED DOOR (125°)							
	Material/Profile colour	Art. no.	Price £	Art. no.	Price £	Art. no.	Price £
	Clear glass/Satin	-	-	-	-	H100-01	458.-
	Height 155cm						
	Min/max adjustment					95-97cm	
	General size guide – exact measurements can be found after product information.						

HANDLES

		2,5CM	
STANDARD HANDLE (INCLUDED WITH ALL DOORS)			
	Colour/Material	Art. no.	Price £
	Chrome	1600640	28.-
	Matt black	1603640	28.-
	Plastic		

FLOW

		2,5CM	
	Colour/Material	Art. no.	Price £
	Chrome	1600641	28.-
	Matt black	1603641	28.-
	Zinc		

ACCESSORIES - INCLUDED AS STANDARD

PVC SEAL, STANDARD (18MM)

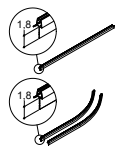

Description	Colour	Art. no.	Price £
For straight doors (1 pcs.)	Clear	1600565	24.-
For straight doors (1 pcs.)	Matt black	1603565	24.-
For curved doors model E (2 pcs.)	Clear	1600566	49.-
For curved doors model E (2 pcs.)	Matt black	1603566	49.-

Cut to suit the relevant enclosure on site

MAGNETIC SEAL

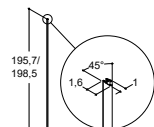

Description	Colour	Art. no.	Price £
For A/B/C/E (1 pcs.)	Clear	1600606	24.-
For A/B/C/E (1 pcs.)	Matt black	1603606	24.-
For D fixed shower panel (1 pcs.)	Clear	1600622	24.-
For D fixed shower panel (1 pcs.)	Matt black	1603622	24.-

ACCESSORIES - EXTRA

FLOOR PROFILE SET FOR DOORS

Provides a power shower proof solution (CE-certified)

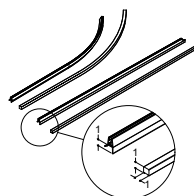

Description	Doors	Colour	Art. no.	Price £
For square enclosures A, B, C	2 doors	Chrome	1600550	73.-
For square enclosures A, B, C	2 doors	Matt black	1603550	73.-
For recess applications 1+A/B/C	1 door	Chrome	1600551	73.-
For recess applications 1+A/B/C	1 door	Matt black	1603551	73.-
For fixed shower panels D+A/B/C	1 door	Chrome	1600552	73.-
For fixed shower panels D+A/B/C	1 door	Matt black	1603552	73.-
For quadrant enclosure E	2 doors	Chrome	1600553	73.-
For quadrant enclosure E	2 doors	Matt black	1603553	73.-

Cut to suit the relevant enclosure on site.

Additional floor profile can be purchased to be installed on the outside of the enclosure for optimal water proofing and enables CE approval in accordance with EN 14428:2015.

This profile can also be easily retro fitted.



PVC SEAL, TALL (28MM)

For use on floors with steep fall towards the drain

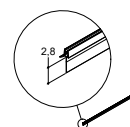

Description	Colour	Art. no.	Price £
For straight doors (2 pcs. set)	Clear	1600560	49.-
For straight doors (2 pcs. set)	Matt black	1603560	49.-
For quadrant doors (2 pcs. set)	Clear	1600561	49.-
For quadrant doors (2 pcs. set)	Matt black	1603561	49.-
For recess doors (1 pcs.)	Clear	1600562	24.-
For recess doors (1 pcs.)	Matt black	1603562	24.-

Cut to suit the relevant enclosure on site

PROFILE 45 DEGREE FOR RECESS SOLUTION

For use in angled recess installations

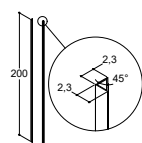

Description	Colour	Art. no.	Price £
Profile (2 pcs.)	Satin	1600506	119.-
Profile (2 pcs.)	Matt black	1603506	119.-

This 45 degree profile is used in angled recessed applications.

Please note this will increase the overall width by 33mm on each side.

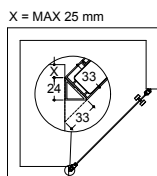

ACCESSORIES - EXTRA

SPACER KITS

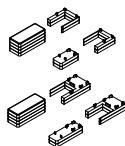

Description	Colour	Art. no.	Price £
2 x 6mm door-door and door-fixed shower panel	Chrome	1600628	49.-
2 x 6mm door-door and door-fixed shower panel	Matt black	1603628	49.-
2 x 6mm door-door and door-fixed shower panel kit for shower extension profile	Chrome	1600629	49.-
2 x 6mm door-door and door-fixed shower panel kit for shower extension profile	Matt black	1603629	49.-

Spacer kits for adjustment of uneven floors

SHOWER EXTENSION PROFILE FOR A, B, E AND WALL PROFILE 1

Exposed pipework can also pass through

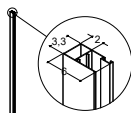

Description	Colour	Art. no.	Price £
200cm for A, B and E	Satin	1600507	119.-
200cm for A, B and E	Matt black	1603507	119.-
197,5cm for 1	Satin	1600534	119.-
197,5cm for 1	Matt black	1603534	119.-

Can be combined with A, B and E.
It is possible to drill a 20-40mm hole for pipework.
Increases the overall size by 20mm.

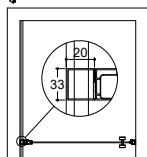

SHOWER EXTENSION PROFILE FOR C AND D

Exposed pipework can also pass through

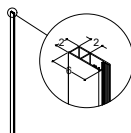

Description	Colour	Art. no.	Price £
199,5cm for C	Satin	1600525	119.-
197,5cm for D	Satin	1600526	119.-
197,5cm for D	Matt black	1603526	119.-

Can be combined with C and D.
It is possible to drill a 20-40mm hole for pipework.
Increases the overall size by 20mm.

PRODUCT INFORMATION

MATCH HINGED AND FIXED SHOWER PANELS

All Match hinged doors and fixed shower panels have been tested to comply with EN 14428:2015 in relation to toughening of glass, stability and water tightness classification.

GLASS

6mm hardened safety glass complying with EN12150 with EasyCare treatment on the inside. Clear glass and some models in frosted glass.

PROFILES

Strong aluminium alloy with hard-wearing satin-anodised or matt black powder-coated surface.

HINGES

Rise and fall hinges that open both inwards and outwards at 180 degrees. The door is held open at 90 degrees either way. Inside the hinge a waterproof seal has been added.

MAGNETIC PROFILES

One removable magnetic profile is supplied with every door and fixed shower panel, that can be combined with profiles across the range. Once the magnet has been activated twice the polarity is set so the two magnetic seals work together. The magnet is located inside a PVC profile, with a matt surface to ensure they do not stick together during prolonged times of little or no use. The angled magnetic catch ensures perfect closure every time. The profile can be fitted in both left and right-hand applications, without the need for tools.

FIXED SHOWER PANEL

The glass panel can be adjusted by 20mm at the wall profile, and is fixed in place with PVC profiles inside the aluminium profile. The floor profile can be adjusted up to 6mm horizontally and using the spacers provided to suit, 12mm vertically. Alternatively, a 12mm adjustable floor bracket can be used for wet room solutions where no seals are required.

DOORS

On models A, B and E the hinge can be adjusted by 20mm at the wall profile for off-square applications. On fixed shower panel models C and D the glass panel is adjusted within the wall profile as it is for fixed shower panels. The floor profile can be adjusted up to 6mm horizontally using the predrilled slot.

HANDLES

Knob style handle in chrome plated or matt black ABS plastic included as standard with all shower doors. Purchase as an extra the longer Flow handle in a zinc alloy - in chrome or matt black.

FITTINGS

Floor brackets and fittings for telescopic support rail and wall support in zinc-aluminium, chrome-plated or matt black powder coated. End caps for profiles and various fittings in chrome-plated or matt black ABS.

TELESCOPIC SUPPORT RAIL

Strong alloy rail with hardwearing, satin-anodised chrome-plated or matt black powder-coated surface with concealed wall fixing bracket. The support rail also has a concealed fixing to the profile and is adjustable from 60 to 100cm.

WALL SUPPORT

Strong alloy wall support with hardwearing, satin-anodised chromeplated or matt black powder-coated surface with fittings in chromeplated zinc aluminium.

SEAL

Clear or matt black PVC seal used with doors at floor level can easily be replaced if required over time. Taller seals can also be purchased separately if required for certain applications.

LEAD-TIME

All Match models are in stock for quick delivery with 1 door/panel in 1 box. All boxes can be handled by one person as they weigh under 30 kg. Accessories like support rails and extra handles are packed separately.

WARRANTY

Dansani offers 10 years warranty against manufacturing defects on all Match models.

Exclusive, very strong and durable shower trays are available as optional extras for certain models.

For more detail please refer to dansani.co.uk

UNCOMPLICATED & EXPERTLY DESIGNED

INSTALLATION

It is likely, that the wall in your bathroom is not completely plumb. Maybe it has small deviations. Maybe it is slightly angled. However we don't think that this should cause the installation of your shower enclosure to present problems. Therefore, Dansani Shower is designed with a number of technical features that make it easy for the installer to fit your new Dansani Shower solution, even on very irregular surfaces. With plenty of adjustment options, you are certain to get a perfect result, irrespective of the solution you choose.

MEASURING

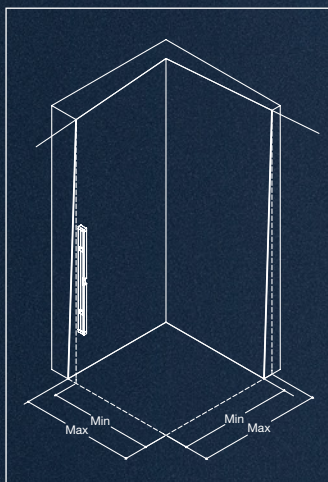

CORNER

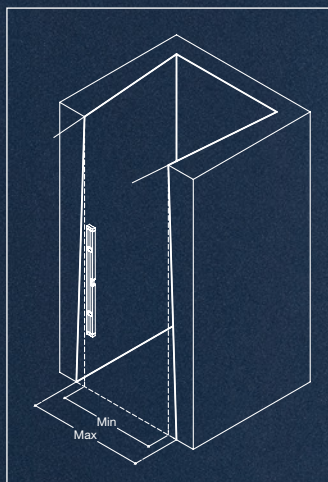

RECESS

Irrespective of whether the wall angles in or out, the adjustment becomes the difference between the minimum and maximum measurements. Use a plumbline to determine the difference along the height of the screen. Before ordering, always check that these measurements correspond to the min./max. measurements of the selected model. Please see the price list.



BE FLEXIBLE WITH

MATCH

Get an overview of the size options for corner solutions, recessed solutions and fixed shower panels. The hinge on all doors can be adjusted by 20mm and the same applies to wall profile 1. In addition a choice of profiles provides more width adjustment options.

MEASUREMENTS READING GUIDE

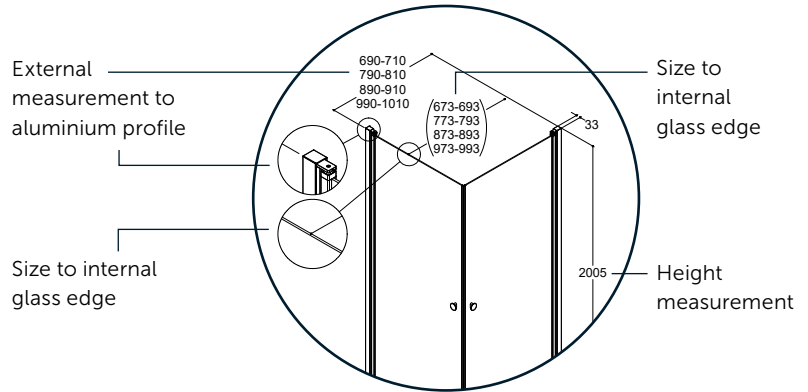

CORNER SOLUTIONS

MODEL A

Hinged door

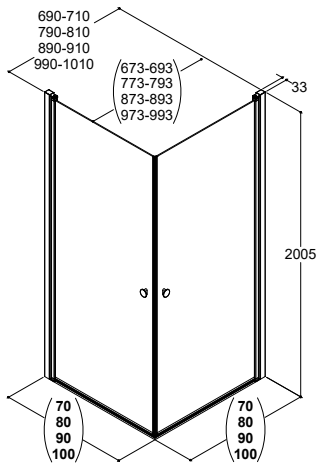

A + A

MODEL B

Bifold door

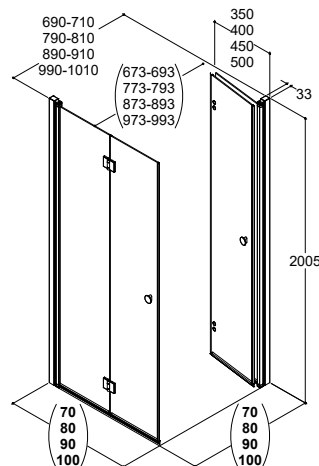

B + B

MODEL C

Hinged door with in-line panel

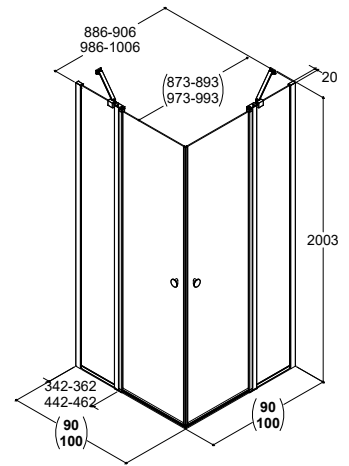

C + C

MODEL E

Quadrant hinged door

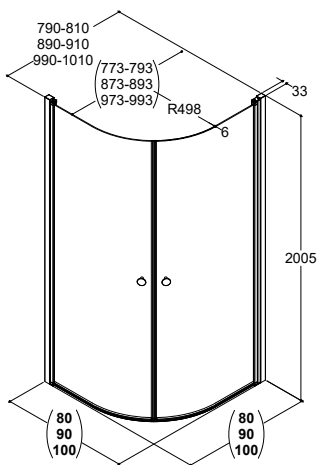

E + E

MODEL A AND D

90° hinged door with fixed shower panel

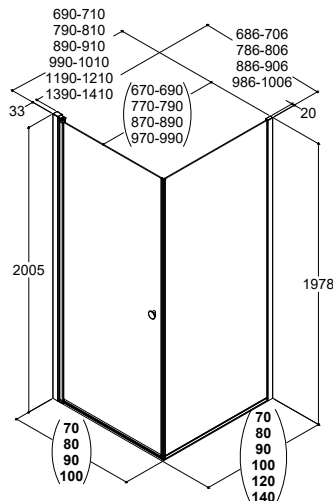

A + D

TOWER STORAGE UNIT

The practical Tower storage unit can be combined with most of the doors or panels to create many different solutions. Simply select the door or panel model that is 10cm narrower than your installation measurements.

»
Height 200cm.

»
Easy cleaning and maintenance with EasyCare treatment on the inside.

^
All models are reversible without having to adjust them or use tools.

^
Shower door handle in stainless steel.

^
Easy to install with two people.

^
Designed for installation on a horizontal surface, floor, or shower base.

∨
Choose between the Classic and Deluxe models (Deluxe shown here).

^
8mm safety glass.

»
Sliding doors in larger widths 120, 140 and 160cm.

«
Sliding door which can be combined with one or two fixed shower panels – as a corner solution or freestanding shower enclosure.

∨
The doors can easily be clipped out to make cleaning easier.

10
YEAR WARRANTY



DANSANI XXL

38 INSPIRATION

48 PRICE LIST

50 PRODUCT INFORMATION

51 DIMENSIONS

52 SHOWER TRAY



140cm Classic - Clear glass
Sliding door 1,040. - Art. no. CL1400-0001

CLASSIC DESIGN & ROBUST QUALITY

CLASSIC MODEL

Classic offers robust quality at a competitive price. This model is perfect for you if you'd like a classic design with a discreet and simple look. The solid runners on the sliding door run inside the profile rail so they aren't visible from the outside of the door. A classic and simple solution.



⤴
 Classic runners
 - exterior view. ⤵
 Classic runner
 - interior view.



⤴
 Classic SoftStop
 function.
 ⤵
 The door clips
 out at the
 bottom for easier
 cleaning.



120 x 90cm Classic - Clear glass
Sliding door/fixed shower panel 1,429.-
Art. no. CL1201-0900 /
Shower tray 546.- Art. no. 1610320

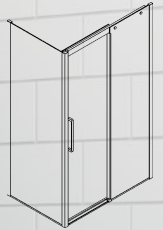



160 x 100cm Classic - Clear glass
Sliding door/2 fixed shower panels 2,349.- Art. no. CL1602-1000

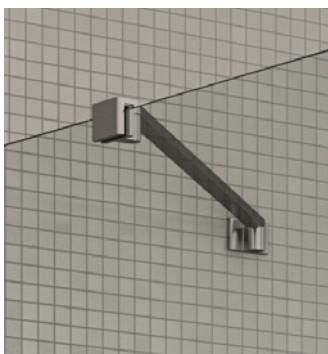

«

For the freestanding shower solution with two fixed shower panels, two support rails are supplied.

»

Shower door handle in stainless steel comes with all models.



SILENT & ELEGANT DESIGN

DELUXE MODEL

Deluxe offers a particularly stable and silent solution with elegant design. The sliding door features two runners placed on a rail above and beneath the profile to ensure a soft and smooth action. The door stops gently against the deluxe SoftStop. Enjoy the feeling of pure luxury and quality.



Deluxe runner - interior view.



Deluxe runners - exterior view.

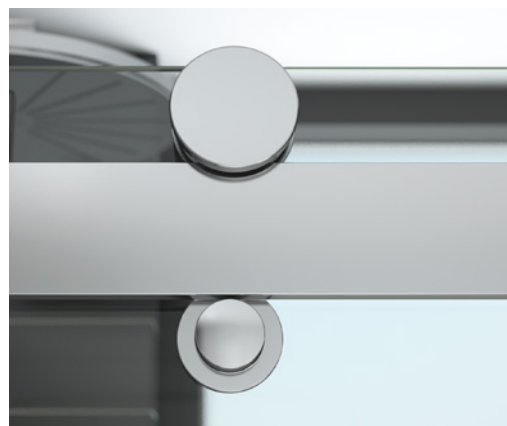

Standard stainless steel handles are supplied with all models.



Deluxe Softstop-function.





120cm Deluxe - Clear glass
Sliding door 1,068.- Art. no. DL1200-0001





160 x 90cm Deluxe - Clear glass
Sliding door/fixed shower panel 1,792.- Art. no. DL1601-0900



140 x 80cm Deluxe - Clear glass

Sliding door/2 fixed shower panels 2,349.- Art. no. DL1402-0800 / Shower tray 546.- Art. no. 1610310



The doors can be easily clipped out at the bottom for easier cleaning.



For the freestanding shower solution with two fixed shower panels, two support rails are supplied.

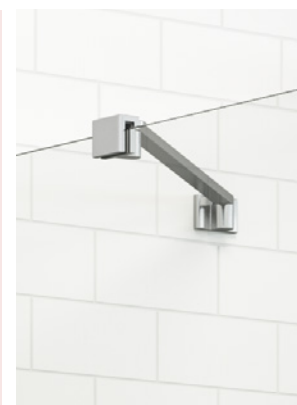

CLASSIC

CLASSIC SLIDING DOOR

Reversible



Dimensions
Min/max adjustment

MODEL 120 CM	
Art. no.	Price £
CL1200-0001	972.-
X: 116,5 - 119cm	

MODEL 140 CM	
Art. no.	Price £
CL1400-0001	1,040.-
X: 136,5 - 139cm	

MODEL 160 CM	
Art. no.	Price £
CL1600-0001	1,186.-
X: 156,5 - 159cm	

CLASSIC SLIDING DOOR WITH 1 FIXED SHOWER PANEL

Reversible

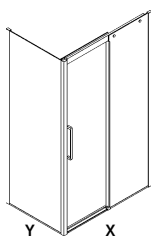

Dimensions
80cm
Min/max adjustment
90cm
Min/max adjustment
100cm
Min/max adjustment

MODEL 120 CM	
Art. no.	Price £
CL1201-0800	1,429.-
X: 116,5 - 119cm x Y: 76,5 - 79cm	
CL1201-0900	1,429.-
X: 116,5 - 119cm x Y: 86,5 - 89cm	
CL1201-1000	1,429.-
X: 116,5 - 119cm x Y: 96,5 - 99cm	

MODEL 140 CM	
Art. no.	Price £
CL1401-0800	1,494.-
X: 136,5 - 139cm x Y: 76,5 - 79cm	
CL1401-0900	1,494.-
X: 136,5 - 139cm x Y: 86,5 - 89cm	
CL1401-1000	1,494.-
X: 136,5 - 139cm x Y: 96,5 - 99cm	

MODEL 160 CM	
Art. no.	Price £
CL1601-0800	1,643.-
X: 156,5 - 159cm x Y: 76,5 - 79cm	
CL1601-0900	1,643.-
X: 156,5 - 159cm x Y: 86,5 - 89cm	
CL1601-1000	1,643.-
X: 156,5 - 159cm x Y: 96,5 - 99cm	

CLASSIC SLIDING DOOR WITH 2 FIXED SHOWER PANELS

Reversible

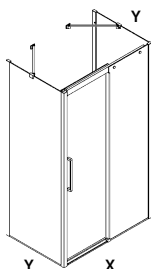

Dimensions
80cm
Min/max adjustment
Incl. 2 pcs. 45cm support rails
90cm
Min/max adjustment
Incl. 2 pcs. 45cm support rails
100cm
Min/max adjustment
Incl. 2 pcs. 60cm support rails

MODEL 120 CM	
Art. no.	Price £
CL1202-0800	2,135.-
X: 116,5 - 119cm x Y: 76,5 - 79cm	
CL1202-0900	2,135.-
X: 116,5 - 119cm x Y: 86,5 - 89cm	
CL1202-1000	2,135.-
X: 116,5 - 119cm x Y: 96,5 - 99cm	

MODEL 140 CM	
Art. no.	Price £
CL1402-0800	2,203.-
X: 136,5 - 139cm x Y: 76,5 - 79cm	
CL1402-0900	2,203.-
X: 136,5 - 139cm x Y: 86,5 - 89cm	
CL1402-1000	2,203.-
X: 136,5 - 139cm x Y: 96,5 - 99cm	

MODEL 160 CM	
Art. no.	Price £
CL1602-0800	2,349.-
X: 156,5 - 159cm x Y: 76,5 - 79cm	
CL1602-0900	2,349.-
X: 156,5 - 159cm x Y: 86,5 - 89cm	
CL1602-1000	2,349.-
X: 156,5 - 159cm x Y: 96,5 - 99cm	

ADD-ON

SHOWER EXTENSION PROFILE

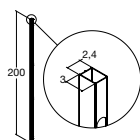

Increases the installation size by 30mm

Art. no.	Price £
1600700	83.-

Art. no.	Price £
1600700	83.-

Art. no.	Price £
1600700	83.-

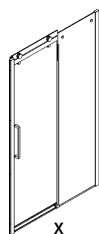
DELUXE**DELUXE SLIDING DOOR**
Reversible**Dimensions**

Min/max adjustment

MODEL 120 CM

Art. no.	Price £
DL1200-0001	1,068.-
X: 116,5 - 119cm	

MODEL 140 CM

Art. no.	Price £
DL1400-0001	1,186.-
X: 136,5 - 139cm	

MODEL 160 CM

Art. no.	Price £
DL1600-0001	1,336.-
X: 156,5 - 159cm	

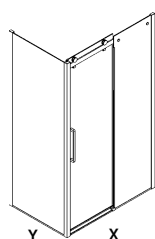
DELUXE SLIDING DOOR WITH 1 FIXED SHOWER PANEL
Reversible**Dimensions**

80cm

Min/max adjustment

90cm

Min/max adjustment

100cm

Min/max adjustment

Art. no.	Price £
DL1201-0800	1,525.-
X: 116,5 - 119cm x Y: 76,5 - 79cm	
DL1201-0900	1,525.-
X: 116,5 - 119cm x Y: 86,5 - 89cm	
DL1201-1000	1,525.-
X: 116,5 - 119cm x Y: 96,5 - 99cm	

Art. no.	Price £
DL1401-0800	1,643.-
X: 136,5 - 139cm x Y: 76,5 - 79cm	
DL1401-0900	1,643.-
X: 136,5 - 139cm x Y: 86,5 - 89cm	
DL1401-1000	1,643.-
X: 136,5 - 139cm x Y: 96,5 - 99cm	

Art. no.	Price £
DL1601-0800	1,792.-
X: 156,5 - 159cm x Y: 76,5 - 79cm	
DL1601-0900	1,792.-
X: 156,5 - 159cm x Y: 86,5 - 89cm	
DL1601-1000	1,792.-
X: 156,5 - 159cm x Y: 96,5 - 99cm	

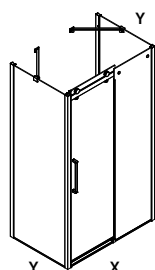
DELUXE SLIDING DOOR WITH 2 FIXED SHOWER PANELS
Reversible**Dimensions**

80cm

Min/max adjustment

Incl. 2 pcs. 45cm support rails

90cm

Min/max adjustment

Incl. 2 pcs. 45cm support rails

100cm

Min/max adjustment

Incl. 2 pcs. 60cm support rails

Art. no.	Price £
DL1202-0800	2,230.-
X: 116,5 - 119cm x Y: 76,5 - 79cm	
DL1202-0900	2,230.-
X: 116,5 - 119cm x Y: 86,5 - 89cm	
DL1202-1000	2,230.-
X: 116,5 - 119cm x Y: 96,5 - 99cm	

Art. no.	Price £
DL1402-0800	2,349.-
X: 136,5 - 139cm x Y: 76,5 - 79cm	
DL1402-0900	2,349.-
X: 136,5 - 139cm x Y: 86,5 - 89cm	
DL1402-1000	2,349.-
X: 136,5 - 139cm x Y: 96,5 - 99cm	

Art. no.	Price £
DL1602-0800	2,499.-
X: 156,5 - 159cm x Y: 76,5 - 79cm	
DL1602-0900	2,499.-
X: 156,5 - 159cm x Y: 86,5 - 89cm	
DL1602-1000	2,499.-
X: 156,5 - 159cm x Y: 96,5 - 99cm	

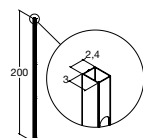
ADD-ON**SHOWER EXTENSION PROFILE**

Increases the installation size by 30mm

Art. no.	Price £
1600700	83.-

Art. no.	Price £
1600700	83.-

Art. no.	Price £
1600700	83.-

DIMENSIONS & PRODUCT INFORMATION

CLASSIC MODEL AND DELUXE

All Dansani sliding doors and fixed shower panels have been tested and comply with regulations EN 14428:2015 in relation to toughening of glass, stability and water proofing classification.

All models are reversible and can be used in both left and right hand applications without the need for tools or modifications.

All models are designed for installation on a horizontal surface, floor, or shower base.

The floor profile can accommodate up to 3 mm of floor unevenness, but in this case, support must be provided at 6 support points so that the support lies in a straight line (see installation instructions M1255 + M1256)

GLASS

8mm safety glass according to EN12150 regulations with easy care treatment on the inside. Available in clear glass.

PROFILES

Strong aluminum profile in satin anodized finish. Wall profiles are adjustable.

HANDLES

Shower door handle in stainless steel.

FITTINGS

Wall bracket and brackets for wall support are in chromed zinc-aluminium. Cover caps in chromed ABS.

INSTALLATION

Perfect installation even on off square walls due to the adjustment options.

CLASSIC MODEL - RUNNERS

Brass with polished chrome finish. The runners are not visible from the outside.

DELUXE MODEL - RUNNERS

The runners are produced in zinc alloy. The fittings for the top bar are made in brass with a refined polished chrome finish.

SUPPORT RAIL

Polished stainless steel with cover caps in chromed ABS. For enclosures with 2 fixed shower panels, 2 wall supports are supplied as standard.

SPARE PARTS

For spare parts please get in touch with your Dansani retailer.

WARRANTY

Dansani offers a 10 year warranty against manufacturing defects on all models.

CLASSIC

Sliding door (reversible)

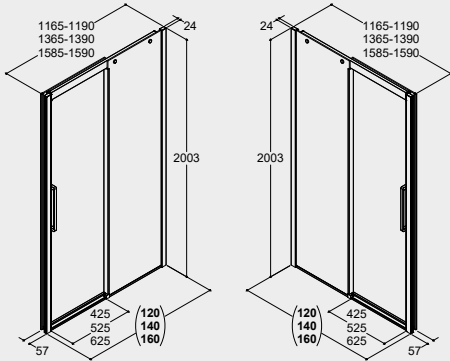

DELUXE

Sliding door (reversible)

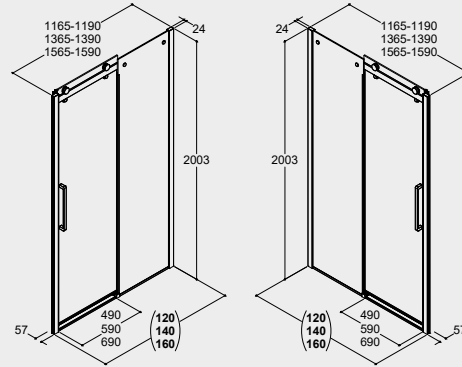

CLASSIC

Sliding door with 1 fixed shower panel (reversible)

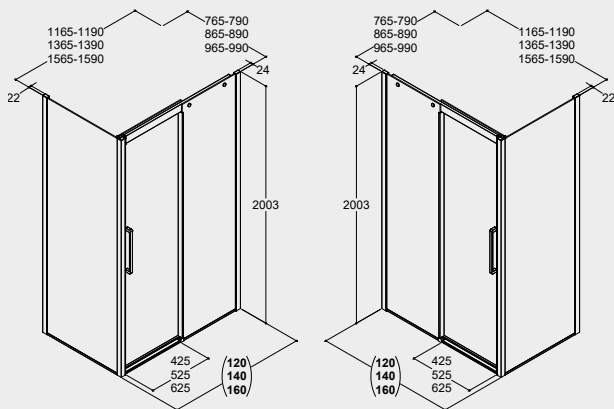

DELUXE

Sliding door with 1 fixed shower panel (reversible)

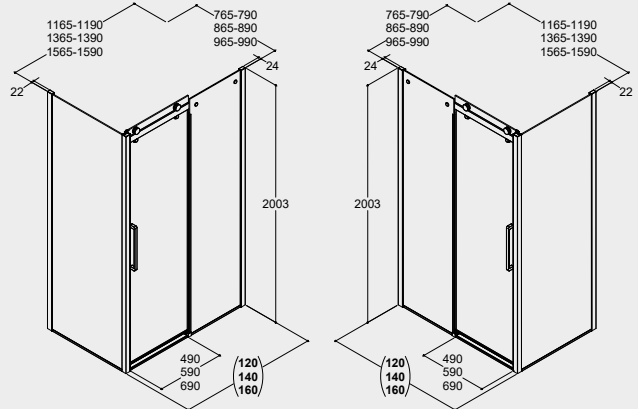

CLASSIC

Sliding door with 2 fixed shower panels (reversible)

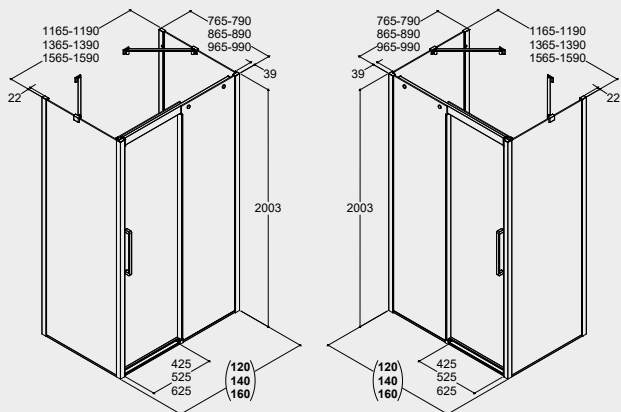

DELUXE

Sliding door with 2 fixed shower panels (reversible)

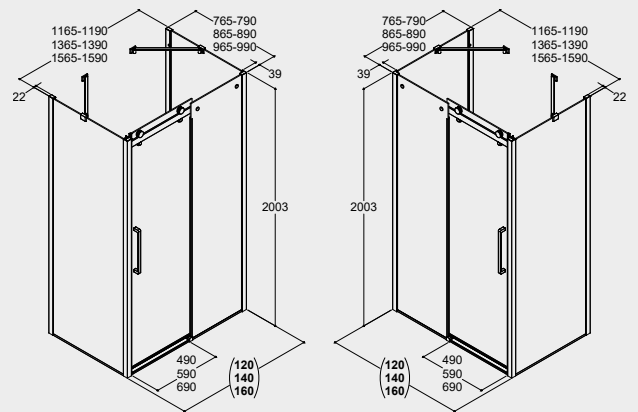

SHOWER TRAYS

SLIM AND SIMPLE SHOWER TRAY WITH A HEIGHT OF ONLY 35MM

Dansani shower trays are manufactured from a fibre-reinforced composite material, which is subjected to a pressure of 2,000 tons and temperatures of up to 190 degrees during production. This process ensures a very uniform, strong and solid product, which is very light in comparison with other solutions.

Height adjustable legs come with all shower bases with fronts.

The waste pipe is horizontal, DN50, 90mm with a waste capacity of 30 l/ min. and a height of 86mm.



INSTALLATION OPTIONS



If you want the shower tray to be raised above the floor to allow the waste, for example, to be run back across the floor, Dansani offers a kit to facilitate this type of installation. The kit comprises a number of adjustable feet, which are easily "clicked" on to the base and ensure stable installation, even on uneven floors. In addition, the kit comprises a front panel (plinth) in a fibre-reinforced material, height 100mm, which is fitted with small clips and makes it easy to remove when cleaning or checking the installation.



If you want the shower tray fitted directly on the floor, stricter requirements are made on the waste and, sealing in to the floor.

SHOWER TRAYS

RECTANGULAR

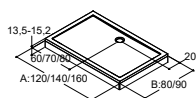

Dimensions

WITHOUT PLINTH

80cm

90cm

WITH PLINTH

80cm

90cm

120CM	
Art. no.	Price £
1610300	546.-
1610320	546.-
1611300	779.-
1611320	779.-

140CM	
Art. no.	Price £
1610310	546.-
1610330	546.-
1611310	779.-
1611330	779.-

160CM	
Art. no.	Price £
-	-
1610340	546.-
-	-
1611340	779.-

Height adjustable without plinth: From 130mm - 152mm
 Total height with plinth 135mm.
 Height of plinth: 100mm.
 Inside depth: 5mm - 20mm

WASTEKIT FOR SHOWER TRAY



Colour	Dimensions	Description	Art. no.	Price £
Chrome	Ø90mm	For 40mm waste incl. adapter for 43cm	1600004	46.-
Chrome	Ø90mm	For 40mm waste incl. adapter for 50cm	1600023	46.-

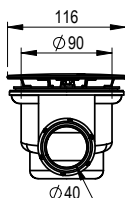
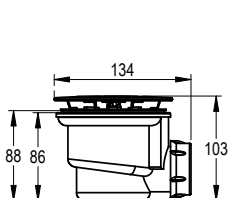





WE TAKE RESPONSIBILITY

SUSTAINABILITY IN EVERY WAY

Dansani takes responsibility and takes good care of our surroundings. We are energy- and consumption-conscious and have always been so - it is part of our DNA. We have dedicated resources when it comes to sustainability initiatives, and we work very closely with our suppliers and are in control of all components that make up our furniture.

Our basis are the 17 UN sustainable development goals.

That means that we generally:

- Develop our products so that their environmental impact in terms of manufacture, usage and, not least, disposal is minimised.
- Use raw materials, water and energy efficiently to reduce the environmental impact.
- Maintain high safety standards for our employees and promote responsible approaches to the environment.

MORE SPECIFICALLY

So what specifically do we do to enable you to make the most sustainable choices? We generally exclusively focus on solutions that also meet our high quality standards - because long durability is an important element in a sustainable product. We therefore have 10-year warranties on all shower solutions. Obviously, it is also possible to repair or switch individual components which may further extend the life of the shower. It could be a PVC seal or a magnet.

Let's take a look at the materials used in Dansani shower solutions. For the Match shower, we use a quality 6mm safety glass that has been treated with the tough and environmentally friendly EasyCare. For large XXL shower solutions, we use a safety glass of 8mm thickness. Thick glass will last for many years, and our glass has also been tested and meets the EN 14428:2015 & EN12150 requirements that relate to stability and toughening.

And then there are the profiles in both shower series. They are a strong aluminum alloy, and is produced using 25% recycled aluminum. It has an incredibly long life as well as functionality and design benefits, and the recycling properties are nearly endless.

PACKAGING

We are in the process of making our packaging more environmentally friendly for you as a consumer. We have been gradually replacing styrofoam with recyclable cell cardboard in our packaging. At the same time, we have reduced the amount of plastic in the packaging of mirrors and shower enclosures. You will start to see these positive changes from the year 2024 onwards. In this way, we are actively working to create a better future for both you and the environment.



Dansani is committed to supporting the UN's global goals. For more detail please visit dansani.co.uk



We're constantly introducing new initiatives - stay tuned here.

IF SOMETHING IS WORTH DOING, IT'S WORTH DOING WELL

At Dansani this is our motto. Since our foundation in 1983 it has always been that way and that's how it will continue in the future. We are bathroom enthusiasts through and through and we want to make the bathroom the best room in the house. Therefore our mission is simple - to develop and produce beautiful and well thought out bathroom concepts that create joy in everyday life.

DANISH DESIGN

Danish design is about putting people at the core of the process – Danish design makes everyday life easier, and it's beautiful and simple to look at. For Dansani, it is the embodiment of our designs. It must be good on the eye, it must work effortlessly and it should feel like coming home.

40 YEARS OF QUALITY CRAFTSMANSHIP

Our craftsmanship is managed in our production facilities in Denmark. We have skilled people with respect for the materials they use and with many years of experience. They engage fully with the products and continuously optimise the processes involved while delivering high quality work every single day is part of their DNA. They do it exactly so that we are absolutely sure of the quality of what we put our logo on.

ENVIRONMENT & SUSTAINABILITY

We have always categorised all waste and been energy conscious at Dansani, and when it comes to our furniture, we make demands on ourselves and on our suppliers. Wood components must be traceable and we keep a keen eye on the proportion of recycled material and not least the energy used in the production of our products. We are honest about the materials we work with and we want to pass on as much information as possible to you as a customer. Read more on our website.



Dansani Ltd
7 Mermaid Walk
The Waterfront
Brighton Marina
East Sussex
BN2 5WA GB
T. 0208 15 76 069
mail@dansani.co.uk
dansani.co.uk



Dansani is committed to supporting the UN's global goals. For more detail please visit dansani.co.uk

