

# Supplies4Heat

Radiators • Towel Rails • Valves



# Supplies4Heat

Radiators • Towel Rails • Valves

[supplies4heat.co.uk](http://supplies4heat.co.uk)



Units 13-14 Charlwoods Road, East Grinstead, West Sussex, RH19 2HU  
Tel. 01342 306880, Fax. 01342 306890, [enquiries@supplies4heat.co.uk](mailto:enquiries@supplies4heat.co.uk)

A brand of **IRSAP**, Italy's leading manufacturer of design led radiators.

Edition 26

[supplies4heat.co.uk](http://supplies4heat.co.uk)

At Supplies4Heat our aim is to provide you with a range of great value designer radiators and towel rails. We understand that you want a choice of good-looking, good-quality products, all delivered with reliable service and guarantees.

### We promise;

- **Great Value:** quality products at affordable prices.
- **All Products from Stock:** ready to be sent when you need them.
- **Free 48-72 hour delivery for stock finishes:** Scotland and offshore islands may take longer where we aim to deliver within 5 working days (please note that delivery times start from order confirmation date).
- **23 RAL Colours & 10 special finishes:** all white radiator & towel rail ranges are available in a choice of 23 RAL Colours & 10 special finishes, see pages 12-13 for full details.
- **+Valves Prices:** best value easy to order bundle options with our **+Valves** prices.
- **Quality Guaranteed:** 10-year guarantee on radiators & towel rails made in our factories.
- **Optional Timed Next-Day Delivery:** on selected Towel Rails, please call **01342 302250** or visit **supplies4heat.co.uk** for more information.

Please visit **supplies4heat.co.uk** for help calculating your heat output requirements, selecting your radiators or finding your local merchant or showroom.

Our network of local Merchants will be able to provide expert advice and help with any plumbing & heating needs.

If you cannot find what you are looking for in this brochure please refer to our sister brand **The Radiator Company** for a wider choice; **www.theradiatorcompany.co.uk** or telephone **01342 302250** for a brochure.

Supplies4Heat is a brand of **IRSAP**, Italy's leading manufacturer of design led radiators.

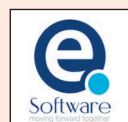

Available on Easyquote



CE/UKCA approved & certified to BS EN442



A member of MARC

## Contents

Product	Pages
<b>RADIATORS</b>	
CORNEL 2 Column	4 - 5
CORNEL 3 Column	6 - 7
CORNEL 4 Column	8 - 9
CORNEL Mounting options	10 - 11
RAL & Special Finishes	12 - 13
CORNEL Textured Anthracite	14 - 17
CORNEL Bare Metal Lacquer	18 - 21
CORNEL Electric	22 - 23
<b>New</b> CORNEL Bench Seat	24 - 25
<b>New</b> CORNEL Curved	26 - 27
FARADAY® Type 11 (K1)	28 - 29
FARADAY® Type 22 (K2)	30 - 31
FARADAY® Type 21 (P+) Horizontal	32 - 33
FARADAY® Type 21 (P+) Vertical	34 - 35
WITTON Type 11 (K1)	36 - 37
WITTON Type 22 (K2)	38 - 39
SAXON Horizontal	40 - 41
SAXON Vertical	42 - 43
HUXLEY	44 - 45
PAXTON	46 - 47
LARKIN	48 - 49
BEAUFORT Max Horizontal	50 - 51
BEAUFORT Max Vertical	52 - 53
BEAUFORT Horizontal	54 - 55
BEAUFORT Vertical	56 - 57
BEAUFORT Slim	58 - 59
TALLIS Textured Anthracite	60 - 61
TALLIS Horizontal	62 - 63
TALLIS Vertical	64 - 65
CHAUCER Horizontal	66 - 67
CHAUCER Vertical	68 - 69
HORNBY (Electric models)	70 - 71

Product	Pages
<b>TOWEL RAILS</b>	
TALLIS Ladder Rail	72
TALLIS Fusion	73
CHAUCER Side Rail	74 - 75
APSLEY (Electric models)	76 - 77
WINSFORD Ladder Rail	78 - 79
ARGYLL (Electric models)	80 - 81
ASHBY	82 - 83
MILTON	84 - 85
LANARK	86 - 87
CLEVES	88 - 89
BOLEYN	90 - 91
<b>New</b> VALVES	92 - 95
ACCESSORIES	96
HANGING PEGS & BARS	97
HEATING ELEMENTS	98 - 99

### Terms & Conditions;

Please note VAT will be charged at the prevailing rate at time of invoice; at the time of going to print VAT is 20%.

**Delivery times start from order confirmation date.**

For a copy of the full Terms & Conditions please call **01342 306880** or visit **supplies4heat.co.uk**

Our Radiators are produced & outputs measured according to the approved standard BS EN442 which uses Delta t50°C (Δt). BS EN442 states that all hydronic radiators and towel rails are tested and presented at Delta T50 or T50. If you need to know outputs based on a different Delta T you can simply multiply the listed Delta T50 outputs by the correction factors shown in the table below to get the appropriate output for your system.

### **New** CORNEL BENCH SEAT, CORNEL CURVED & DELTA T CORRECTION FACTOR TABLE



CORNEL Bench (page 24-25)



CORNEL Curved (pages 26-27)

DELTA T	FACTORS	DELTA T	FACTORS
75°	1.69	45°	0.87
70°	1.55	40°	0.75
65°	1.41	35°	0.63
60°	1.27	30°	0.51
55°	1.13	25°	0.41
50°	1	20°	0.3

DELTA T correction factor table



# CORNEL 2 Column

- Italian design & manufacture, steel multi column radiator
- Wall brackets as standard; alternative mounting options available (pg.10)
- Standard white RAL 9016 delivered in 48-72 hours
- 23 RAL colours, 10 special finishes, up to 8 working days (pg.12-13)



## Sizes and Prices

Please add 10% to the RAL colour price to work out your special finish price.

Dimensions (mm)			Sections	Output Δt 50°C		Product Code	White Ex VAT	White Inc VAT	RAL Colour Ex VAT	RAL Colour Inc VAT	White +Valves Ex VAT	White +Valves Inc VAT	RAL Colour +Valves Ex VAT	RAL Colour +Valves Inc VAT
Height	Width	Depth		Watts	Btu's									
<b>Horizontal</b>														
500	611	65	13	468	1597	CORN2C506013H	£271.00	£325.20	£381.00	£457.20	£339.00	£406.80	£449.00	£538.80
	836	65	18	648	2211	CORN2C508318H	£360.00	£432.00	£512.00	£614.40	£428.00	£513.60	£580.00	£696.00
	1016	65	22	792	2702	CORN2C501022H	£428.00	£513.60	£623.00	£747.60	£496.00	£595.20	£691.00	£829.20
	1196	65	26	936	3194	CORN2C501126H	£495.00	£594.00	£727.00	£872.40	£563.00	£675.60	£795.00	£954.00
	1376	65	30	1080	3685	CORN2C501330H	£586.00	£703.20	£884.00	£1,060.80	£654.00	£784.80	£952.00	£1,142.40
600	611	65	13	559	1907	CORN2C606013H	£282.00	£338.40	£384.00	£460.80	£350.00	£420.00	£452.00	£542.40
	836	65	18	774	2641	CORN2C608318H	£372.00	£446.40	£511.00	£613.20	£440.00	£528.00	£579.00	£694.80
	1016	65	22	946	3228	CORN2C601022H	£444.00	£532.80	£659.00	£790.80	£512.00	£614.40	£727.00	£872.40
	1196	65	26	1118	3815	CORN2C601126H	£522.00	£626.40	£743.00	£891.60	£590.00	£708.00	£811.00	£973.20
	1376	65	30	1290	4401	CORN2C601330H	£613.00	£735.60	£940.00	£1,128.00	£681.00	£817.20	£1,008.00	£1,209.60
750	521	65	11	572	1952	CORN2C755111H	£243.00	£291.60	£380.00	£456.00	£311.00	£373.20	£448.00	£537.60
	611	65	13	676	2307	CORN2C756013H	£299.00	£358.80	£449.00	£538.80	£367.00	£440.40	£517.00	£620.40
	836	65	18	936	3194	CORN2C758318H	£393.00	£471.60	£595.00	£714.00	£461.00	£553.20	£663.00	£795.60
<b>Vertical</b>														
1800	341	65	7	868	2962	CORN2C183307V	£297.00	£356.40	£427.00	£512.40	£365.00	£438.00	£495.00	£594.00
	431	65	9	1116	3808	CORN2C184209V	£376.00	£451.20	£543.00	£651.60	£444.00	£532.80	£611.00	£733.20
	521	65	11	1364	4654	CORN2C185111V	£455.00	£546.00	£653.00	£783.60	£523.00	£627.60	£721.00	£865.20
	611	65	13	1612	5500	CORN2C186013V	£536.00	£643.20	£763.00	£915.60	£604.00	£724.80	£831.00	£997.20

Widths include measurement for bushes. Please note due to manufacturing tolerances widths shown may vary by +/- 2mm. See page 11 for pipe centres.  
 \*+Valves Prices include a choice of either chrome or white, angled KINGSTON TRVs, (if you require straight valves please specify).

### CORNEL alternative mounting options

Please refer to pages 10-11 for alternative mounting options and pipe centre information.

Optional slip on Feet



Optional floor mounts



23 RAL colours & 10 special finishes available (see pages 12-13 for full RAL and special finish options).

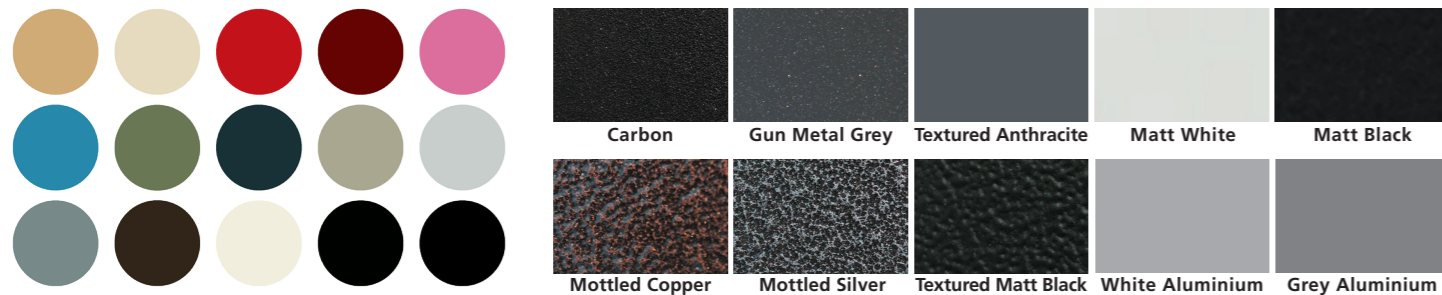

Please add 10% to the RAL colour price to work out your special finish price.

Please note due to printing processes & manufacturing tolerances the colour of finished radiators may vary from the colours represented in this brochure.

+Valves Prices include angled chrome or white KINGSTON TRVs

Please specify at time of order



Mottled Copper finish



Matching CORNEL towel bar (pg.11)



♦ CORNEL vertical 2 column, 1800mm x 341mm with optional slip on feet and white KINGSTON TRVs.



# CORNEL 3 Column

- Italian design & manufacture, steel multi column radiator
- Wall brackets as standard; alternative mounting options available (pg.10)
- Standard white RAL 9016 delivered in 48-72 hours
- 23 RAL colours, 10 special finishes, up to 8 working days (pg.12-13)



## Sizes and Prices

Please add 10% to the RAL colour price to work out your special finish price.

Dimensions (mm)			Sections	Output Δt 50°C		Product Code	White Ex VAT	White Inc VAT	RAL Colour Ex VAT	RAL Colour Inc VAT	White +Valves Ex VAT	White +Valves Inc VAT	RAL Colour +Valves Ex VAT	RAL Colour +Valves Inc VAT
Height	Width	Depth		Watts	Btu's									
<b>Horizontal</b>														
300	971	101	21	672	2293	CORN3C309621H	£416.00	£499.20	£563.00	£675.60	£484.00	£580.80	£631.00	£757.20
	1196	101	26	832	2839	CORN3C301126H	£504.00	£604.80	£679.00	£814.80	£572.00	£686.40	£747.00	£896.40
	1376	101	30	960	3276	CORN3C301330H	£569.00	£682.80	£773.00	£927.60	£637.00	£764.40	£841.00	£1,009.20
400	971	101	21	882	3009	CORN3C409621H	£448.00	£537.60	£665.00	£798.00	£516.00	£619.20	£733.00	£879.60
	1196	101	26	1092	3726	CORN3C401126H	£552.00	£662.40	£813.00	£975.60	£620.00	£744.00	£881.00	£1,057.20
	1376	101	30	1260	4299	CORN3C401330H	£635.00	£762.00	£933.00	£1,119.60	£703.00	£843.60	£1,001.00	£1,201.20
500	611	101	13	663	2262	CORN3C506013H	£286.00	£343.20	£415.00	£498.00	£354.00	£424.80	£483.00	£579.60
	836	101	18	918	3132	CORN3C508318H	£387.00	£464.40	£582.00	£698.40	£455.00	£546.00	£650.00	£780.00
	1016	101	22	1122	3828	CORN3C501022H	£508.00	£609.60	£752.00	£902.40	£576.00	£691.20	£820.00	£984.00
	1196	101	26	1326	4524	CORN3C501126H	£572.00	£686.40	£867.00	£1,040.40	£640.00	£768.00	£935.00	£1,122.00
	1376	101	30	1530	5220	CORN3C501330H	£663.00	£795.60	£950.00	£1,140.00	£731.00	£877.20	£1,018.00	£1,221.60
	1601	101	35	1785	6090	CORN3C501535H	£776.00	£931.20	£1,157.00	£1,388.40	£844.00	£1,012.80	£1,225.00	£1,470.00
600	1826	101	40	2040	6960	CORN3C501840H	£885.00	£1,062.00	£1,321.00	£1,585.20	£953.00	£1,143.60	£1,389.00	£1,666.80
	611	101	13	780	2661	CORN3C606013H	£290.00	£348.00	£418.00	£501.60	£358.00	£429.60	£486.00	£583.20
	836	101	18	1080	3685	CORN3C608318H	£397.00	£476.40	£587.00	£704.40	£465.00	£558.00	£655.00	£786.00
	1016	101	22	1320	4504	CORN3C601022H	£521.00	£625.20	£760.00	£912.00	£589.00	£706.80	£828.00	£993.60
	1196	101	26	1560	5323	CORN3C601126H	£577.00	£692.40	£868.00	£1,041.60	£645.00	£774.00	£936.00	£1,123.20
	1376	101	30	1800	6142	CORN3C601330H	£671.00	£805.20	£1,032.00	£1,238.40	£739.00	£886.80	£1,100.00	£1,320.00
	1601	101	35	2100	7165	CORN3C601535H	£788.00	£945.60	£1,205.00	£1,446.00	£856.00	£1,027.20	£1,273.00	£1,527.60
750	1826	101	40	2400	8189	CORN3C601840H	£895.00	£1,074.00	£1,374.00	£1,648.80	£963.00	£1,155.60	£1,442.00	£1,730.40
	521	101	11	814	2777	CORN3C755111H	£284.00	£340.80	£443.00	£531.60	£352.00	£422.40	£511.00	£613.20
	611	101	13	962	3282	CORN3C756013H	£349.00	£418.80	£510.00	£612.00	£417.00	£500.40	£578.00	£693.60
	836	101	18	1332	4545	CORN3C758318H	£459.00	£550.80	£679.00	£814.80	£527.00	£632.40	£747.00	£896.40
	1016	101	22	1628	5555	CORN3C751022H	£569.00	£682.80	£832.00	£998.40	£637.00	£764.40	£900.00	£1,080.00
<b>Vertical</b>														
1800	341	101	7	1176	4013	CORN3C183307V	£412.00	£494.40	£613.00	£735.60	£480.00	£576.00	£681.00	£817.20
	431	101	9	1512	5159	CORN3C184209V	£507.00	£608.40	£749.00	£898.80	£575.00	£690.00	£817.00	£980.40
	521	101	11	1848	6305	CORN3C185111V	£595.00	£714.00	£870.00	£1,044.00	£663.00	£795.60	£938.00	£1,125.60
	611	101	13	2184	7452	CORN3C186013V	£719.00	£862.80	£1,040.00	£1,248.00	£787.00	£944.40	£1,108.00	£1,329.60

Widths include measurement for bushes. Please note due to manufacturing tolerances widths shown may vary by +/- 2mm. See page 11 for pipe centres.

\*+Valves Prices include a choice of either chrome or white, angled KINGSTON TRVs, (if you require straight valves please specify).

### CORNEL alternative mounting options

Please refer to page 10 for alternative mounting options; slip on feet plus floor mounts as well as pipe centre information.

#### Optional slip on feet

Please add 100mm to your overall height.

#### Optional floor mounts

Please add 105mm to your overall height.

#### Optional slip on Feet

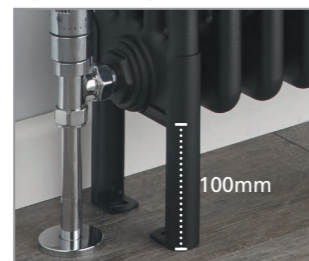

#### Optional floor mounts



+Valves Prices include angled chrome or white KINGSTON TRVs



Please specify at time of order

◆ CORNELL 3 column, 600mm x 836mm in special finish Mottled Copper with optional slip on feet & antique copper KINGSTON TRVs.



# CORNEL 4 Column

- Italian design & manufacture, steel multi column radiator
- Wall brackets as standard; alternative mounting options available (pg.10)
- Standard white RAL 9016 delivered in 48-72 hours
- 23 RAL colours, 10 special finishes, up to 8 working days (pg.12-13)



## Sizes and Prices

Please add 10% to the RAL colour price to work out your special finish price.

Dimensions (mm)			Sections	Output Δt 50°C		Product Code	White Ex VAT	White Inc VAT	RAL Colour Ex VAT	RAL Colour Inc VAT	White +Valves Ex VAT	White +Valves Inc VAT	RAL Colour +Valves Ex VAT	RAL Colour +Valves Inc VAT
Height	Width	Depth		Watts	Btu's									
<b>Horizontal</b>														
300	971	139	21	882	3009	CORN4C309621H	£484.00	£580.80	£638.00	£765.60	£552.00	£662.40	£706.00	£847.20
	1196	139	26	1092	3726	CORN4C301126H	£579.00	£694.80	£767.00	£920.40	£647.00	£776.40	£835.00	£1,002.00
	1376	139	30	1260	4299	CORN4C301330H	£656.00	£787.20	£873.00	£1,047.60	£724.00	£868.80	£941.00	£1,129.20
400	971	139	21	1134	3869	CORN4C409621H	£480.00	£576.00	£650.00	£780.00	£548.00	£657.60	£718.00	£861.60
	1196	139	26	1404	4790	CORN4C401126H	£591.00	£709.20	£797.00	£956.40	£659.00	£790.80	£865.00	£1,038.00
	1376	139	30	1620	5527	CORN4C401330H	£679.00	£814.80	£915.00	£1,098.00	£747.00	£896.40	£983.00	£1,179.60
500	611	139	13	858	2927	CORN4C506013H	£322.00	£386.40	£461.00	£553.20	£390.00	£468.00	£529.00	£634.80
	836	139	18	1188	4053	CORN4C508318H	£445.00	£534.00	£662.00	£794.40	£513.00	£615.60	£730.00	£876.00
	1016	139	22	1452	4954	CORN4C501022H	£554.00	£664.80	£821.00	£985.20	£622.00	£746.40	£889.00	£1,066.80
	1196	139	26	1716	5855	CORN4C501126H	£661.00	£793.20	£973.00	£1,167.60	£729.00	£874.80	£1,041.00	£1,249.20
	1376	139	30	1980	6756	CORN4C501330H	£745.00	£894.00	£1,097.00	£1,316.40	£813.00	£975.60	£1,165.00	£1,398.00
	1601	139	35	2310	7882	CORN4C501535H	£861.00	£1,033.20	£1,278.00	£1,533.60	£929.00	£1,114.80	£1,346.00	£1,615.20
600	1826	139	40	2640	9008	CORN4C501840H	£985.00	£1,182.00	£1,456.00	£1,747.20	£1,053.00	£1,263.60	£1,524.00	£1,828.80
	611	139	13	1027	3504	CORN4C606013H	£324.00	£388.80	£463.00	£555.60	£392.00	£470.40	£531.00	£637.20
	836	139	18	1422	4852	CORN4C608318H	£452.00	£542.40	£665.00	£798.00	£520.00	£624.00	£733.00	£879.60
	1016	139	22	1738	5930	CORN4C601022H	£560.00	£672.00	£824.00	£988.80	£628.00	£753.60	£892.00	£1,070.40
	1196	139	26	2054	7008	CORN4C601126H	£667.00	£800.40	£977.00	£1,172.40	£735.00	£882.00	£1,045.00	£1,254.00
750	1376	139	30	2370	8086	CORN4C601330H	£752.00	£902.40	£1,141.00	£1,369.20	£820.00	£984.00	£1,209.00	£1,450.80
	521	139	11	1056	3603	CORN4C755111H	£308.00	£369.60	£483.00	£579.60	£376.00	£451.20	£551.00	£661.20
	611	139	13	1248	4258	CORN4C756013H	£368.00	£441.60	£555.00	£666.00	£436.00	£523.20	£623.00	£747.60
	836	139	18	1728	5896	CORN4C758318H	£516.00	£619.20	£743.00	£891.60	£584.00	£700.80	£811.00	£973.20
1016	139	22	2112	7206	CORN4C751022H	£605.00	£726.00	£900.00	£1,080.00	£673.00	£807.60	£968.00	£1,161.60	
<b>Vertical</b>														
1800	341	139	7	1512	5159	CORN4C183307V	£504.00	£604.80	£708.00	£849.60	£572.00	£686.40	£776.00	£931.20
	431	139	9	1944	6633	CORN4C184209V	£643.00	£771.60	£900.00	£1,080.00	£711.00	£853.20	£968.00	£1,161.60
	521	139	11	2376	8107	CORN4C185111V	£783.00	£939.60	£1,090.00	£1,308.00	£851.00	£1,021.20	£1,158.00	£1,389.60
	611	139	13	2808	9581	CORN4C186013V	£921.00	£1,105.20	£1,280.00	£1,536.00	£989.00	£1,186.80	£1,348.00	£1,617.60

Widths include measurement for bushes. Please note due to manufacturing tolerances widths shown may vary by +/- 2mm. See page 11 for pipe centres.

\*+Valves Prices include a choice of either chrome or white, angled KINGSTON TRVs, (if you require straight valves please specify).

### CORNEL alternative mounting options

Please refer to pages 10-11 for alternative mounting options and pipe centre information.

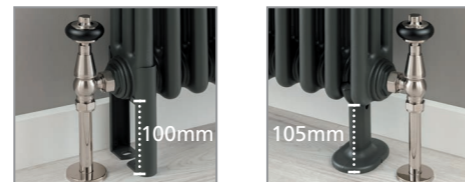

+Valves Prices include angled chrome or white KINGSTON TRVs

Please specify at time of order

♦ CORNEL horizontal 4 column, 500mm x 836mm in RAL 7016 Anthracite Grey with optional slip on feet and chrome KINGSTON TRVs.



# CORNEL

## Steel Multi Column

White RAL 9016 supplied as standard

45mm mild steel sections - up to 40 sections available



## ALTERNATIVE MOUNTING OPTIONS

**Wall Brackets**  
(supplied as standard)



**Please Note:** 2 slip on feet / floor mounts per radiator up to 18 sections, 4 feet for 21-40 sections.

**Optional Slip on Feet**  
(adds 100mm to the overall height)



**Optional Floor Mounts**  
(adds 105mm to the overall height)



**Optional Stud Wall Brackets**  
(minimum height from floor = 100mm)



Pipe centres from wall  
2 & 3 Column = 70mm - 80mm  
4 Column = 95mm - 130mm

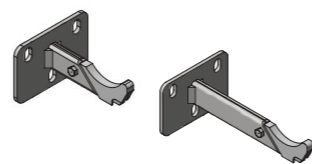

Description	Kit Quantity	Column	Product Code	White Ex VAT	White Inc VAT	RAL Colour Ex VAT	RAL Colour Inc VAT
Slip on Feet kit	2	2, 3 & 4 Column	CORNSOF2	£88.00	£105.60	£100.00	£120.00
	4	2, 3 & 4 Column	CORNSOF4	£176.00	£211.20	£200.00	£240.00
Floor Mount kit	2	2, 3 & 4 Column	CORNF2	£54.00	£64.80	£74.00	£88.80
	4	2, 3 & 4 Column	CORNF4	£108.00	£129.60	£148.00	£177.60
Stud Wall Bracket kit	4	2, 3 & 4 Column	CORNSTWB4	£66.00	£79.20	£88.00	£105.60
	6	2, 3 & 4 Column	CORNSTWB6	£99.00	£118.80	£132.00	£158.40

Please add 10% to the RAL colour price to work out your special finish price.

# CORNEL

## Steel Multi Column

### PIPE CENTRES

Pipe centres left to right

= width of radiator plus valves

Pipe centres from wall  
(Based on adjustable wall ties)

= 2 column = 64mm - 74mm

= 3 column = 82mm - 92mm

= 4 column = 102mm - 112mm

### BORE CENTRES

Bore centres = height less 65mm

Bore centres from base = 32.5mm

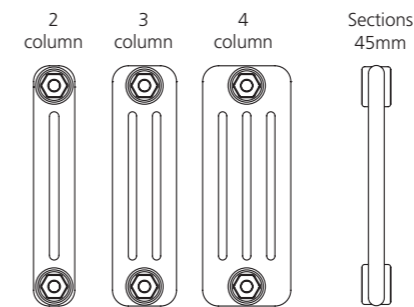

## ACCESSORIES



### Optional CORNEL Towel Bar

Description	Product Code	Price Ex VAT	Price Inc VAT
Chrome Towel Bar to fit 8 Sections or more	CORNTB08SEC	£108.00	£129.60
Chrome Towel Bar to fit 10 Sections or more	CORNTB10SEC	£118.00	£141.60

Please note: The towel bar will sit off centre for CORNEL radiators that have an uneven number of sections.

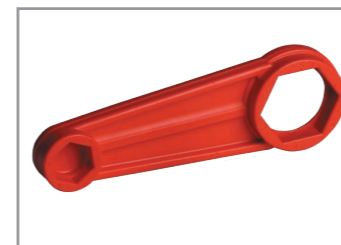

### Nylon Spanner

Description	Product Code	Price Ex VAT	Price Inc VAT
Nylon Spanner	MCSPANNER	£11.00	£13.20

Perfect for tightening CORNEL bushes and airvents, this robust nylon spanner is an exact fit and will reduce the risk of damaging your radiator with inappropriate metal tools.



CORNEL 4 column 1800mm x 431mm in special finish Matt White with optional slip on welded feet & white Kingston TRVs & matching pipe covers & shrouds.



# 23 RAL COLOURS

All white radiator & towel rail ranges are also available in a choice of 23 RAL Colours or one of 10 special finishes (excluding the ARGYLL, TALLIS FUSION, LANARK, CLEVES & BOLEYN towel rails and all electric models)

Your new radiator or towel rail will be painted by our UK based specialists in a long-lasting satin finish. To allow for the colour process, delivery will be up to 10 working days to UK mainland invoice addresses (8 working days for CORNEL (excluding Curved) plus towel rails), offshore islands may take longer where we aim to deliver within 20 working days. For orders of more than 10 radiators please allow an additional 5 working days. 23 popular RAL colours to choose from, painted in a satin sheen finish, similar to eggshell.

For help choosing your finish, colour chips samples are available to order, please contact Customer Services on 01342 306880 or visit [supplies4heat.co.uk](http://supplies4heat.co.uk) to order your sample.

RAL 9016 - Traffic White supplied as standard (excluding the SAXON which is supplied in RAL 9010 as standard).



Please note delivery dates can only be confirmed once we have receipt of your chosen RAL colour number or special finish; please ensure your selected colour number and name and or special finish is included on your order.

Please contact Customer Services on 01342 306880 or visit [supplies4heat.co.uk](http://supplies4heat.co.uk) to order a colour chip sample.

# 10 SPECIAL FINISHES

Please add 10% to the RAL Colour price to work out your Special Finish price.



Please contact Customer Services on 01342 306880 or visit [supplies4heat.co.uk](http://supplies4heat.co.uk) to order a colour chip sample.

To discuss a quotation for other colours outside of the above range please call 01342 306880.



Please note: Due to the printing process and manufacturing tolerances the colour (including white) of a finished radiator may vary slightly from the colours represented in this brochure. It should also be noted that the final finished colour of radiators ordered in the same colour but at different times may vary due to production processes.



# CORNEL Textured Anthracite



- Italian design & manufacture, steel multi column horizontal radiator
- Wall brackets as standard; optional slip on feet available
- 2, 3 & 4 column options in 4 heights & up to 11 widths; set sizes only
- Delivered within 48-72 hours



Dimensions (mm)				Sections	Output Δt 50°C		Product Code	Textured Anthracite Ex VAT	Textured Anthracite Inc VAT	Textured Anthracite +Valves Ex VAT	Textured Anthracite +Valves Inc VAT
No. of Columns	Height	Width	Depth		Watts	Btu's					
<b>Horizontal</b>											
2 Column	600	611	65	13	559	1907	CORN2C606013HTA	£332.00	£398.40	£435.00	£522.00
		836	65	18	774	2641	CORN2C608318HTA	£457.00	£548.40	£560.00	£672.00
		1016	65	22	946	3228	CORN2C601022HTA	£551.00	£661.20	£654.00	£784.80
		1196	65	26	1118	3815	CORN2C601126HTA	£649.00	£778.80	£752.00	£902.40
3 Column	500	431	101	9	459	1566	CORN3C504209HTA	£256.00	£307.20	£359.00	£430.80
		611	101	13	663	2262	CORN3C506013HTA	£362.00	£434.40	£465.00	£558.00
		836	101	18	918	3132	CORN3C508318HTA	£498.00	£597.60	£601.00	£721.20
		1016	101	22	1122	3828	CORN3C501022HTA ♦	£604.00	£724.80	£707.00	£848.40
	1196	101	26	1326	4524	CORN3C501126HTA	£711.00	£853.20	£814.00	£976.80	
	600	611	101	13	780	2661	CORN3C606013HTA	£368.00	£441.60	£471.00	£565.20
		836	101	18	1080	3685	CORN3C608318HTA	£504.00	£604.80	£607.00	£728.40
		1016	101	22	1320	4504	CORN3C601022HTA	£610.00	£732.00	£713.00	£855.60
1196		101	26	1560	5323	CORN3C601126HTA	£718.00	£861.60	£821.00	£985.20	
4 Column	500	476	139	10	660	2252	CORN4C504710HTA	£314.00	£376.80	£417.00	£500.40
		611	139	13	858	2927	CORN4C506013HTA	£403.00	£483.60	£506.00	£607.20
		836	139	18	1188	4053	CORN4C508318HTA	£551.00	£661.20	£654.00	£784.80
		1016	139	22	1452	4954	CORN4C501022HTA	£671.00	£805.20	£774.00	£928.80
	1196	139	26	1716	5855	CORN4C501126HTA	£790.00	£948.00	£893.00	£1,071.60	
	600	611	139	13	1027	3504	CORN4C606013HTA	£408.00	£489.60	£511.00	£613.20
		836	139	18	1422	4852	CORN4C608318HTA	£559.00	£670.80	£662.00	£794.40
		1016	139	22	1738	5930	CORN4C601022HTA	£681.00	£817.20	£784.00	£940.80
1196		139	26	2054	7008	CORN4C601126HTA	£800.00	£960.00	£903.00	£1,083.60	

Widths include measurement for bushes. Please note due to manufacturing tolerances widths shown may vary by +/- 2mm.

\*+Valves Prices include nickel KINGSTON TRVs (angled as standard), please specify if you require straight at time of order.

## Optional slip on feet kits

(2 feet per radiator up to 18 sections, 22 & 26 sections require 4 feet).

Description	Kit Quantity	Product Code	Textured Anthracite Ex VAT	Textured Anthracite Inc VAT
2, 3, & 4 Column	2	CORNSOF2TA	£100.00	£120.00
	4	CORNSOF4TA	£200.00	£240.00

Pipe centres left to right = width of radiator plus valves

Pipe centres from wall = 2 column = 64mm - 74mm  
 = 3 column = 82mm - 92mm  
 = 4 column = 102mm - 112mm

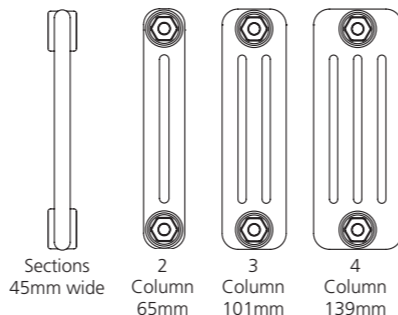

+Valves Prices include angled nickel KINGSTON TRVs



Please specify at time of order

♦ CORNEL in Textured Anthracite, 3 column, 500mm x 1016mm with optional slip on feet and nickel BELSAY TRVs.

If you would like an alternative size in our Textured Anthracite finish, we have a wider selection available with a delivery time of 8 working days; please see pages 4-9 for more information.



# CORNEL Textured Anthracite

- Italian design & manufacture, steel multi column vertical radiator
- Wall brackets as standard; optional slip on feet available
- 2, 3 & 4 column options in 4 heights & up to 11 widths; set sizes only
- Delivered within 48-72 hours



## Sizes and Prices

Dimensions (mm)				Sections	Output Δt 50°C		Product Code	Textured Anthracite Ex VAT	Textured Anthracite Inc VAT	Textured Anthracite +Valves Ex VAT	Textured Anthracite +Valves Inc VAT
No. of Columns	Height	Width	Depth		Watts	Btu's					
<b>Vertical</b>											
2 Column	1500	296	65	6	618	2109	CORN2C152906VTA	£258.00	£309.60	£361.00	£433.20
		386	65	8	824	2811	CORN2C153808VTA	£337.00	£404.40	£440.00	£528.00
		476	65	10	1030	3514	CORN2C154710VTA	£419.00	£502.80	£522.00	£626.40
	1800	206	65	4	496	1692	CORN2C182004VTA	£214.00	£256.80	£317.00	£380.40
		341	65	7	868	2962	CORN2C183307VTA	£360.00	£432.00	£463.00	£555.60
		431	65	9	1116	3808	CORN2C184209VTA	£459.00	£550.80	£562.00	£674.40
		521	65	11	1364	4654	CORN2C185111VTA	£555.00	£666.00	£658.00	£789.60
		611	65	13	1612	5500	CORN2C186013VTA	£654.00	£784.80	£757.00	£908.40
3 Column	1800	341	101	7	1176	4013	CORN3C183307VTA	£519.00	£622.80	£622.00	£746.40
		431	101	9	1512	5159	CORN3C184209VTA ♦	£665.00	£798.00	£768.00	£921.60
		521	101	11	1848	6305	CORN3C185111VTA	£807.00	£968.40	£910.00	£1,092.00
		611	101	13	2184	7452	CORN3C186013VTA	£951.00	£1,141.20	£1,054.00	£1,264.80

Widths include measurement for bushes. Please note due to manufacturing tolerances widths shown may vary by +/- 2mm.

\*+Valves Prices include nickel KINGSTON TRVs (angled as standard), please specify if you require straight at time of order.

## Optional slip on feet kits

(2 feet per radiator up to 18 sections, 22 & 26 sections require 4 feet).

Description	Kit Quantity	Product Code	Textured Anthracite Ex VAT	Textured Anthracite Inc VAT
2, 3, & 4 Column	2	CORNSOF2TA	£100.00	£120.00
	4	CORNSOF4TA	£200.00	£240.00



Pipe centres left to right

= width of radiator plus valves

Pipe centres from wall

= 2 column = 64mm - 74mm

(Based on adjustable wall ties)

= 3 column = 82mm - 92mm

= 4 column = 102mm - 112mm

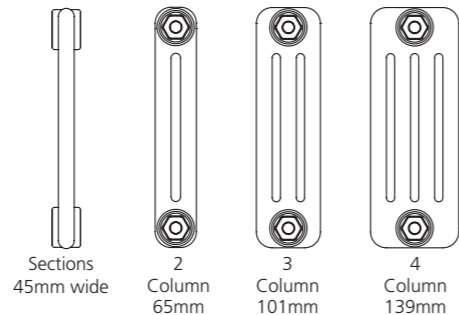

Horizontal

+Valves Prices include angled nickel KINGSTON TRVs



Please specify at time of order



4 column in Textured Anthracite



If you would like an alternative size in our Textured Anthracite finish we have a wider selection available with a delivery time of 8 working days; please see pages 4-9 for more information.

♦ CORNEL Textured Anthracite vertical 3 column, 1800mm x 431mm with slip on feet & chrome SHIRE TRVs.



# CORNEL Bare Metal Lacquer

- Italian design & manufacture, steel multi column vertical radiator
- 2 & 3 column options in 2 heights & up to 8 widths; set sizes only
- Universal wall brackets as standard, optional slip on feet available
- Delivered within 48-72 hours



All prices include universal wall brackets. Slip on feet available at a supplementary price, please specify at time of order.

Dimensions (mm)				Sections	Output Δt 50°C		Product Code	Lacquer Ex VAT	Lacquer Inc VAT	Lacquer +Valves Ex VAT	Lacquer +Valves Inc VAT
No. of Columns	Height	Width	Depth		Watts	Btu's					
<b>Vertical</b>											
2 Column	1500	296	65	6	618	2109	CORN2C152906VL	£263.00	£315.60	£366.00	£439.20
		386	65	8	824	2811	CORN2C153808VL	£343.00	£411.60	£446.00	£535.20
		476	65	10	1030	3514	CORN2C154710VL	£427.00	£512.40	£530.00	£636.00
	1800	206	65	4	496	1692	CORN2C182004VL	£218.00	£261.60	£321.00	£385.20
		341	65	7	868	2962	CORN2C183307VL	£367.00	£440.40	£470.00	£564.00
		431	65	9	1116	3808	CORN2C184209VL	£468.00	£561.60	£571.00	£685.20
		521	65	11	1364	4654	CORN2C185111VL	£566.00	£679.20	£669.00	£802.80
3 Column	1800	611	65	13	1612	5500	CORN2C186013VL	£667.00	£800.40	£770.00	£924.00
		341	101	7	1176	4013	CORN3C183307VL	£529.00	£634.80	£632.00	£758.40
		431	101	9	1512	5159	CORN3C184209VL	£677.00	£812.40	£780.00	£936.00
		521	101	11	1848	6305	CORN3C185111VL	£823.00	£987.60	£926.00	£1,111.20
		611	101	13	2184	7452	CORN3C186013VL	£969.00	£1,162.80	£1,072.00	£1,286.40

Widths include measurement for bushes. Please note due to manufacturing tolerances widths shown may vary by +/- 2mm.

\*+Valves Prices include nickel KINGSTON TRVs (angled as standard), please specify if you require straight at time of order.

## Universal Wall Brackets (Supplied as standard)

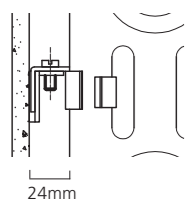

## Optional slip on feet kits

(2 feet per radiator up to 18 sections, 22 & 26 sections require 4 feet).

Description	Kit Quantity	Product Code	Lacquer Ex VAT	Lacquer Inc VAT
2, 3, & 4 Column	2	CORNSOF2L	£106.00	£127.20
	4	CORNSOF4L	£212.00	£254.40

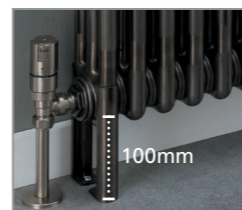

## Pipe Centres for Bare Metal Lacquer only

Pipe centres left to right = Width of radiator plus valves  
 Pipe centres from wall = 2 column = 56mm, 3 column = 74mm, 4 column = 93mm

## Bare Metal Lacquer Finish

Each radiator will be unique, with the random position of the weld lines on the column tubes and the level of the final sanding.

The clear lacquer allows these characteristics to be the hero and maintains the natural steel finish.



Black weld lines



Sanding marks

+Valves Prices include angled nickel KINGSTON TRVs



Please specify at time of order



Horizontal version with slip on feet (pg.20-21)



Black weld lines and manufacturing marks create industrial chic



♦ CORNEL Bare Metal Lacquer vertical 2 Column, 1800mm x 431mm with wall brackets & nickel KINGSTON TRVs.



# CORNEL Bare Metal Lacquer

- Italian design & manufacture, steel multi column horizontal radiator
- 2, 3 & 4 column options in 2 heights & up to 6 widths; set sizes only
- Universal wall brackets as standard, optional slip on feet available
- Delivered within 48-72 hours



All prices include universal wall brackets. Slip on feet available at a supplementary price, please specify at time of order.

Dimensions (mm)				Sections	Output Δt 50°C		Product Code	Lacquer Ex VAT	Lacquer Inc VAT	Lacquer +Valves Ex VAT	Lacquer +Valves Inc VAT
No. of Columns	Height	Width	Depth		Watts	Btu's					
<b>Horizontal</b>											
2 Column	500	431	65	9	324	1105	CORN2C504209HL	£230.00	£276.00	£333.00	£399.60
		611	65	13	468	1597	CORN2C506013HL	£325.00	£390.00	£428.00	£513.60
		836	65	18	648	2211	CORN2C508318HL	£444.00	£532.80	£547.00	£656.40
		1016	65	22	792	2702	CORN2C501022HL	£539.00	£646.80	£642.00	£770.40
	600	1196	65	26	936	3194	CORN2C501126HL	£633.00	£759.60	£736.00	£883.20
		611	65	13	559	1907	CORN2C606013HL	£338.00	£405.60	£441.00	£529.20
		836	65	18	774	2641	CORN2C608318HL	£465.00	£558.00	£568.00	£681.60
		1016	65	22	946	3228	CORN2C601022HL	£562.00	£674.40	£665.00	£798.00
3 Column	500	431	101	9	459	1566	CORN3C504209HL	£261.00	£313.20	£364.00	£436.80
		611	101	13	663	2262	CORN3C506013HL	£369.00	£442.80	£472.00	£566.40
		836	101	18	918	3132	CORN3C508318HL	£507.00	£608.40	£610.00	£732.00
		1016	101	22	1122	3828	CORN3C501022HL	£615.00	£738.00	£718.00	£861.60
	600	1196	101	26	1326	4524	CORN3C501126HL	£724.00	£868.80	£827.00	£992.40
		611	101	13	780	2661	CORN3C606013HL	£375.00	£450.00	£478.00	£573.60
		836	101	18	1080	3685	CORN3C608318HL	£514.00	£616.80	£617.00	£740.40
		1016	101	22	1320	4504	CORN3C601022HL	£622.00	£746.40	£725.00	£870.00
4 Column	500	476	139	10	660	2252	CORN4C504710HL	£320.00	£384.00	£423.00	£507.60
		611	139	13	858	2927	CORN4C506013HL	£411.00	£493.20	£514.00	£616.80
		836	139	18	1188	4053	CORN4C508318HL	£562.00	£674.40	£665.00	£798.00
		1016	139	22	1452	4954	CORN4C501022HL	£684.00	£820.80	£787.00	£944.40
	600	1196	139	26	1716	5855	CORN4C501126HL	£805.00	£966.00	£908.00	£1,089.60
		611	139	13	1027	3504	CORN4C606013HL	£416.00	£499.20	£519.00	£622.80
		836	139	18	1422	4852	CORN4C608318HL	£569.00	£682.80	£672.00	£806.40
		1016	139	22	1738	5930	CORN4C601022HL	£694.00	£832.80	£797.00	£956.40
		1196	139	26	2054	7008	CORN4C601126HL	£815.00	£978.00	£918.00	£1,101.60

Widths include measurement for bushes. Please note due to manufacturing tolerances widths shown may vary by +/- 2mm.

\*+Valves Prices include Nickel KINGSTON TRVs (angled as standard), please specify if you require Straight at time of order.

## Universal Wall Brackets (Supplied as standard)

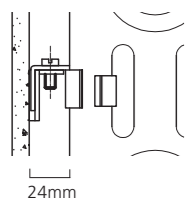

## Optional Slip on Feet Kits

(2 feet per radiator up to 18 sections, 22 & 26 Sections require 4 feet).

Description	Kit Quantity	Product Code	Lacquer Ex VAT	Lacquer Inc VAT
2, 3, & 4 Column	2	CORNSOF2L	£106.00	£127.20
	4	CORNSOF4L	£212.00	£254.40

## Pipe Centres for Bare Metal Lacquer only

Pipe centres left to right = Width of radiator plus valves  
 Pipe centres from wall = 2 column = 56mm, 3 column = 74mm, 4 column = 93mm

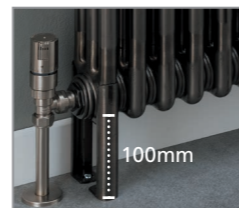

+Valves Prices include Angled Nickel KINGSTON TRVs



Please specify at time of order

◆ CORNEL Bare Metal Lacquer Horizontal 3 Column, 500mm x 1016mm with optional Slip on Feet and Nickel KINGSTON TRVs.



# CORNEL Electric

- Italian design & manufacture, steel multi column radiator
- 3 column electric radiator with wall brackets
- 2-year guarantee on the element, 10-years on the radiator
- White RAL 9016 only delivered in 48-72 hours



## Sizes and Prices

Dimensions (mm)			Sections	Output $\Delta t$ 50°C	Product Code	White Ex VAT	White Inc VAT
Height	Width	Depth		Watts			
<b>Horizontal</b>							
600	708	101	14	800	CORN3C607014EW	£804.00	£964.80
	843	101	17	1000	CORN3C608417EW	£941.00	£1,129.20
	978	101	20	1200	CORN3C609720EW ♦	£1,078.00	£1,293.60
	1113	101	23	1500	CORN3C601123EW	£1,215.00	£1,458.00

Widths include measurement for bushes. Please note due to manufacturing tolerances widths shown may vary by +/- 2mm.

The Cornel Electric range combines the classic Cornel design with the flexibility of a fully controllable electric element. Offering 8 function modes, the Cornel Electric can be set to operate when you wish, on a daily basis, or you can select one of the three pre-set programmes. The Open Window Function detects an open external door or window and will turn the radiator off if it detects that it is allowing heat to escape, saving energy and money.

## Technical Drawings

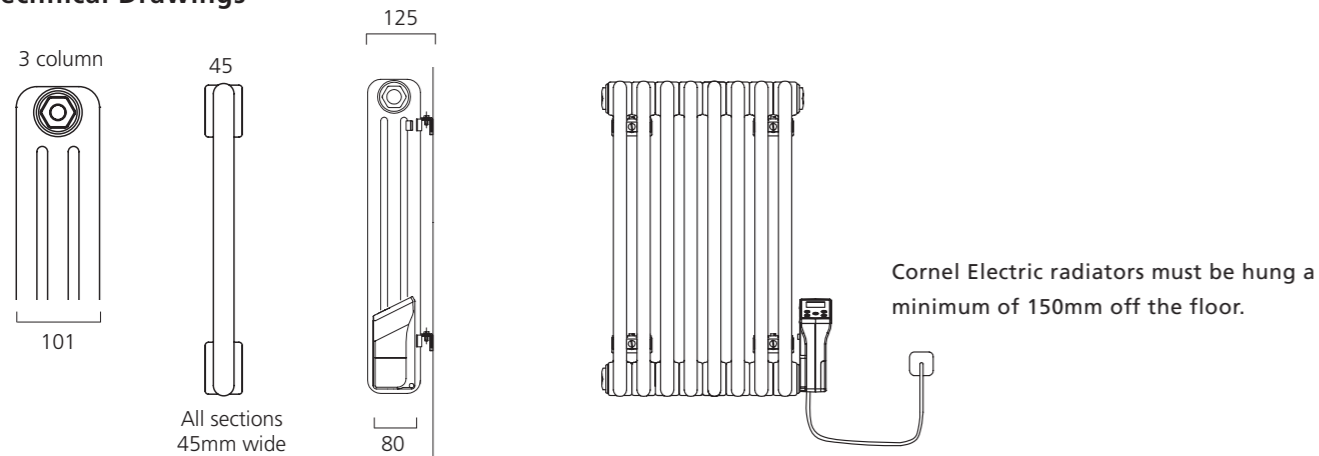

- IP24
- 8 operating modes: weekly program, 3 integrated pre-set timed programs, pilot-wire facility, comfort, night and antifreeze
- Open Window Function
- 2-Year Guarantee on the element



♦ CORNEL Electric 3 column, 600mm x 978mm in White RAL 9016.



# CORNEL Bench Seat

- Italian design & manufacture, steel multi column with optional seat
- 4 column option in 1 height & up to 15 widths; set sizes only
- White 9016 delivered in 48-72 hours
- 23 RAL colours, 10 special finishes, up to 8 working days (pg.12-13)



## Radiator Sizes & Prices (excluding bench seat)

Please add 10% to the RAL colour price to work out your special finish price.

Dimensions (mm)			Sections	Output Δt 50°C		Product Code	White Ex VAT	White Inc VAT	RAL Colour Ex VAT	RAL Colour Inc VAT	White +Valves Ex VAT	White +Valves Inc VAT	RAL Colour +Valves Ex VAT	RAL Colour +Valves Inc VAT
Height	Width	Depth		Watts	Btu's									
496	476	142	10	420	1433	CORNBENCH4C3010	£282.00	£338.40	£381.00	£457.20	£350.00	£420.00	£449.00	£538.80
	566	142	12	504	1720	CORNBENCH4C3012	£329.00	£394.80	£442.00	£530.40	£397.00	£476.40	£510.00	£612.00
	611	142	13	546	1863	CORNBENCH4C3013	£352.00	£422.40	£472.00	£566.40	£420.00	£504.00	£540.00	£648.00
	656	142	14	588	2006	CORNBENCH4C3014	£375.00	£450.00	£503.00	£603.60	£443.00	£531.60	£571.00	£685.20
	701	142	15	630	2150	CORNBENCH4C3015	£398.00	£477.60	£533.00	£639.60	£466.00	£559.20	£601.00	£721.20
	881	142	19	798	2723	CORNBENCH4C3019	£490.00	£588.00	£654.00	£784.80	£558.00	£669.60	£722.00	£866.40
	926	142	20	840	2866	CORNBENCH4C3020	£513.00	£615.60	£684.00	£820.80	£581.00	£697.20	£752.00	£902.40
	1016	142	22	924	3153	CORNBENCH4C3022	£559.00	£670.80	£745.00	£894.00	£627.00	£752.40	£813.00	£975.60
	1061	142	23	966	3296	CORNBENCH4C3023	£582.00	£698.40	£775.00	£930.00	£650.00	£780.00	£843.00	£1,011.60
	1151	142	25	1050	3583	CORNBENCH4C3025	£654.00	£784.80	£875.00	£1,050.00	£722.00	£866.40	£943.00	£1,131.60
	1511	142	33	1386	4729	CORNBENCH4C3033	£838.00	£1,005.60	£1,118.00	£1,341.60	£906.00	£1,087.20	£1,186.00	£1,423.20
	1601	142	35	1470	5016	CORNBENCH4C3035	£884.00	£1,060.80	£1,178.00	£1,413.60	£952.00	£1,142.40	£1,246.00	£1,495.20
	1781	142	39	1638	5589	CORNBENCH4C3039	£977.00	£1,172.40	£1,299.00	£1,558.80	£1,045.00	£1,254.00	£1,367.00	£1,640.40
	1871	142	41	1722	5875	CORNBENCH4C3041	£1,023.00	£1,227.60	£1,360.00	£1,632.00	£1,091.00	£1,309.20	£1,428.00	£1,713.60
	2231	142	49	2058	7022	CORNBENCH4C3049	£1,207.00	£1,448.40	£1,602.00	£1,922.40	£1,275.00	£1,530.00	£1,670.00	£2,004.00

Widths include measurement for bushes. Please note due to manufacturing tolerances widths shown may vary by +/- 2mm.

\*+Valves Prices include a choice of either Chrome or White, angled KINGSTON TRVs, (if you require straight valves please specify).

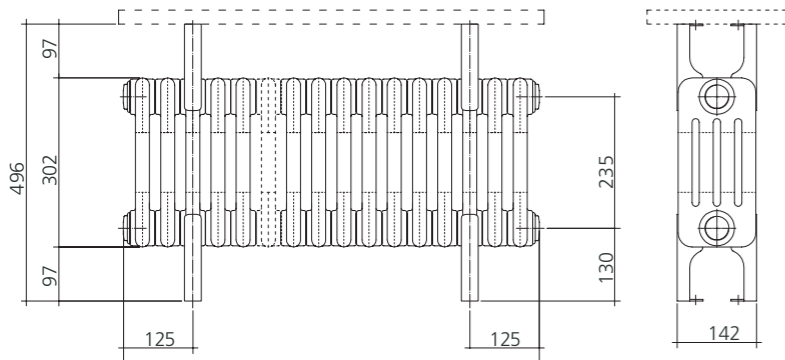

**Please note:**  
All radiators will be supplied with the correct number of feet.

Pipe centres = width of radiator + valves

## Bench Seat Sizes & Prices

Bench seats are made from fir wood.

Seat Length (mm)	Recommended for use with (mm)	Product Code	Price Ex VAT	Price Inc VAT
650	476 wide	BENCHSEAT650	£257.00	£308.40
815	566, 611, and 656 wide	BENCHSEAT815	£313.00	£375.60
1015	701 wide	BENCHSEAT1015	£347.00	£416.40
1350	881, 926, 1016, and 1061 wide	BENCHSEAT1350	£364.00	£436.80
1650	1151 wide	BENCHSEAT1650	£394.00	£472.80
1950	1511 and 1601 wide	BENCHSEAT1950	£415.00	£498.00
2150	1781 and 1871 wide	BENCHSEAT2150	£454.00	£544.80
2650	2231 wide	BENCHSEAT2650	£559.00	£670.80

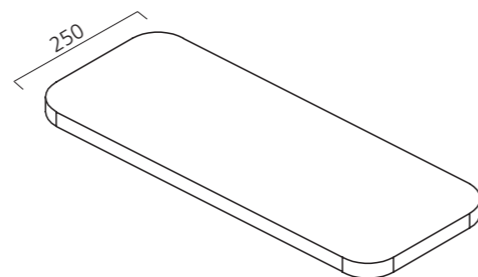

CORNEL Bench shown without Seat

◆ CORNEL Bench Seat in RAL 7016 with optional wooden seat, 4 column, 496mm x 1016mm with Nickel Kingston TRVs.



# CORNEL Curved



- Italian design & manufacture, made to order curved radiators
- 2, 3 & 4 column options in a choice of 2 heights in up to 40 sections
- Available in White RAL 9016, 23 RAL colours & 10 special finishes
- Delivery 6 weeks from receipt of written sign off of technical drawings

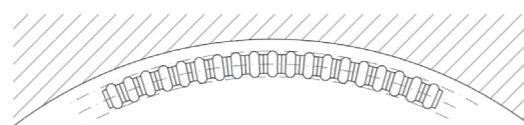

Internal CORNEL Curved

Our CORNEL Curved radiators are made to order and can be curved to fit bay windows. Wall brackets are supplied as standard, optional welded feet are available, please specify at time of order.

Radiators can be curved using up to 40 sections, minimum 10 sections (450mm).

It is essential to always know how much heat you need to keep your room comfortable.

Use our online **Heat Output Calculator** to work out how much heat you will need for your room before you size your straight radiator.

Curving is a precise process and as such, accurate measurements and calculations must be made and checked before production can begin.

Since our CORNEL Curved is made on a bespoke basis to your exact requirements, we have created a specification form to make the process as easy as possible;



**To order your curved radiator follow these simple steps;**

- Go to our website [supplies4heat.co.uk](http://supplies4heat.co.uk) and select 'Cornel Curved' (or scan QR code above) and download the specification form which explains how to measure for your curved radiator, we can also email the specification form to you direct by calling **01342 306880**.
- When you have reviewed the specification form, double-check your measurements are correct to see how your radiator will fit in your space.
- Complete the specification form with the dimensions of your bay and return it to your chosen merchant/installer to place an initial order.
- You will receive a technical drawing of your bay and requested measurements from your merchant and if you are happy you will need to sign the document.
- Use the signed specification form to place your order with your merchant/installer to start production.

Please note; once you have signed off your drawings and ordered your curved radiator it cannot be cancelled or returned.

Calculate the number of sections you need by dividing the required BTU (Watt) output with the output per section; e.g 4500 BTUs divided by 225 = 20 sections, based on 4 column, 500mm high sections (always round up to the next whole number of sections). If the use of this section size does not work in the available space, try a different column option or if possible a different height.

## Sizes and Prices (by section)

### 2 Column - 65mm deep

Dimensions (mm)		Output Δt 50°C		Product Code	White Ex VAT	White Inc VAT	RAL Colour Ex VAT	RAL Colour Inc VAT	Special Finishes Ex VAT	Special Finishes Inc VAT
Height		Watts	Btu's							
500		36	123	CORC2C50	£41.68	£50.02	£43.59	£52.31	£47.95	£57.54
600		43	147	CORC2C60	£43.23	£51.88	£45.31	£54.37	£49.84	£59.81

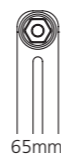

65mm

### 3 Column - 101mm deep

Dimensions (mm)		Output Δt 50°C		Product Code	White Ex VAT	White Inc VAT	RAL Colour Ex VAT	RAL Colour Inc VAT	Special Finishes Ex VAT	Special Finishes Inc VAT
Height		Watts	Btu's							
500		51	174	CORC3C50	£44.85	£53.82	£47.09	£56.51	£51.80	£62.16
600		60	205	CORC3C60	£45.77	£54.92	£48.11	£57.73	£52.92	£63.51

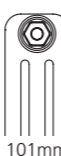

101mm



Sections 45mm wide

### 4 Column - 139mm deep

Dimensions (mm)		Output Δt 50°C		Product Code	White Ex VAT	White Inc VAT	RAL Colour Ex VAT	RAL Colour Inc VAT	Special Finishes Ex VAT	Special Finishes Inc VAT
Height		Watts	Btu's							
500		66	225	CORC4C50	£48.18	£57.82	£50.75	£60.90	£55.83	£66.99
600		79	270	CORC4C60	£50.62	£60.74	£53.43	£64.12	£58.77	£70.53

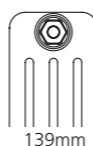

139mm

### Optional Welded Feet kits

Note: Please remember to add 97mm to the height of the CORNEL curved section you have chosen if you are using Welded Feet.

Sections	Product Code	No. of Feet	White Ex VAT	White Inc VAT	RAL Colour Ex VAT	RAL Colour Inc VAT	Special Finishes Ex VAT	Special Finishes Inc VAT
Up to 20 Sections	CORCWFKIT2	2	£88.00	£105.60	£100.00	£120.00	£110.00	£132.00
21-39 (odd number of sections)	CORCWFKIT3	3	£132.00	£158.40	£150.00	£180.00	£165.00	£198.00
22-40 (even number of sections)	CORCWFKIT4	4	£176.00	£211.20	£200.00	£240.00	£220.00	£264.00



97mm



CORNEL Curved with wall brackets

◆ CORNEL Curved in White RAL 9016, 3 column, 597mm x 1826mm with optional welded feet shown with White Kingston TRVs.



# FARADAY® Type 11 (K1)

- Smooth plain front with a single flat panel and a single convector
- Steel flat panel radiator available in 3 heights and 12 widths
- Standard white RAL 9016 delivered in 48-72 hours
- 23 RAL colours, 10 special finishes, up to 10 working days (pg.12-13)



## Sizes and Prices

Please add 10% to the RAL colour price to work out your special finish price.

Dimensions (mm)			Output Δt 50°C		Product Code	White Ex VAT	White Inc VAT	RAL Colour Ex VAT	RAL Colour Inc VAT	White +Valves Ex VAT	White +Valves Inc VAT	RAL Colour +Valves Ex VAT	RAL Colour +Valves Inc VAT
Height	Width	Depth	Watts	Btu's									
400	400	65	271	925	FARA404011	£107.00	£128.40	£276.00	£331.20	£175.00	£210.00	£344.00	£412.80
	600	65	407	1389	FARA406011	£143.00	£171.60	£291.00	£349.20	£211.00	£253.20	£359.00	£430.80
	800	65	542	1849	FARA408011	£177.00	£212.40	£359.00	£430.80	£245.00	£294.00	£427.00	£512.40
	1000	65	678	2313	FARA401011	£213.00	£255.60	£415.00	£498.00	£281.00	£337.20	£483.00	£579.60
	1100	65	746	2545	FARA401111	£229.00	£274.80	£449.00	£538.80	£297.00	£356.40	£517.00	£620.40
	1200	65	814	2777	FARA401211	£247.00	£296.40	£469.00	£562.80	£315.00	£378.00	£537.00	£644.40
	1400	65	949	3238	FARA401411	£294.00	£352.80	£550.00	£660.00	£362.00	£434.40	£618.00	£741.60
	1600	65	1085	3702	FARA401611	£328.00	£393.60	£612.00	£734.40	£396.00	£475.20	£680.00	£816.00
	1800	65	1220	4163	FARA401811	£361.00	£433.20	£689.00	£826.80	£429.00	£514.80	£757.00	£908.40
	2000	65	1356	4627	FARA402011	£394.00	£472.80	£790.00	£948.00	£462.00	£554.40	£858.00	£1,029.60
500	400	65	327	1116	FARA504011	£113.00	£135.60	£303.00	£363.60	£181.00	£217.20	£371.00	£445.20
	600	65	491	1675	FARA506011	£150.00	£180.00	£335.00	£402.00	£218.00	£261.60	£403.00	£483.60
	800	65	654	2231	FARA508011	£184.00	£220.80	£386.00	£463.20	£252.00	£302.40	£454.00	£544.80
	1000	65	818	2791	FARA501011	£220.00	£264.00	£458.00	£549.60	£288.00	£345.60	£526.00	£631.20
	1100	65	900	3071	FARA501111	£236.00	£283.20	£473.00	£567.60	£304.00	£364.80	£541.00	£649.20
	1200	65	982	3351	FARA501211	£258.00	£309.60	£539.00	£646.80	£326.00	£391.20	£607.00	£728.40
	1400	65	1145	3907	FARA501411	£310.00	£372.00	£632.00	£758.40	£378.00	£453.60	£700.00	£840.00
	1600	65	1309	4466	FARA501611	£346.00	£415.20	£699.00	£838.80	£414.00	£496.80	£767.00	£920.40
	1800	65	1472	5022	FARA501811	£362.00	£434.40	£784.00	£940.80	£430.00	£516.00	£852.00	£1,022.40
	2000	65	1636	5582	FARA502011	£395.00	£474.00	£882.00	£1,058.40	£463.00	£555.60	£950.00	£1,140.00
600	400	65	381	1300	FARA604011	£138.00	£165.60	£365.00	£438.00	£206.00	£247.20	£433.00	£519.60
	600	65	572	1952	FARA606011	£164.00	£196.80	£384.00	£460.80	£232.00	£278.40	£452.00	£542.40
	700	65	667	2276	FARA607011	£187.00	£224.40	£432.00	£518.40	£255.00	£306.00	£500.00	£600.00
	800	65	762	2600	FARA608011	£210.00	£252.00	£469.00	£562.80	£278.00	£333.60	£537.00	£644.40
	900	65	858	2927	FARA609011	£231.00	£277.20	£520.00	£624.00	£299.00	£358.80	£588.00	£705.60
	1000	65	953	3252	FARA601011	£255.00	£306.00	£558.00	£669.60	£323.00	£387.60	£626.00	£751.20
	1100	65	1048	3576	FARA601111	£280.00	£336.00	£611.00	£733.20	£348.00	£417.60	£679.00	£814.80
	1200	65	1144	3903	FARA601211	£294.00	£352.80	£645.00	£774.00	£362.00	£434.40	£713.00	£855.60
	1400	65	1334	4552	FARA601411	£352.00	£422.40	£783.00	£939.60	£420.00	£504.00	£851.00	£1,021.20
	1600	65	1525	5203	FARA601611	£393.00	£471.60	£880.00	£1,056.00	£461.00	£553.20	£948.00	£1,137.60
1800	65	1715	5852	FARA601811	£463.00	£555.60	£970.00	£1,164.00	£531.00	£637.20	£1,038.00	£1,245.60	
2000	65	1906	6503	FARA602011	£508.00	£609.60	£1,086.00	£1,303.20	£576.00	£691.20	£1,154.00	£1,384.80	

\*+Valves Prices include a choice of either Chrome or White, angled KINGSTON TRVs, (if you require straight valves please specify).

## Pipe Centres and Technical Drawings

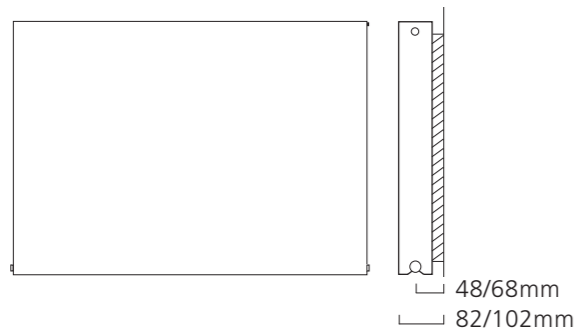

### Type 11 (K1) Profile

Single steel panel with a single convector.



Pipe centres left to right = Width plus valves  
 Pipe centres from wall = 48mm / 68mm  
 Depth from wall = 82mm / 102mm

© FARADAY is a registered trademark of IRSAP UK Limited.



+Valves Prices include angled chrome or white KINGSTON TRVs

Please specify at time of order

♦FARADAY® Type 11 (K1) 500mm x 1000mm in White RAL 9016 shown with WELLINGTON TRVs and White Radsnaps.



# FARADAY® Type 22 (K2)

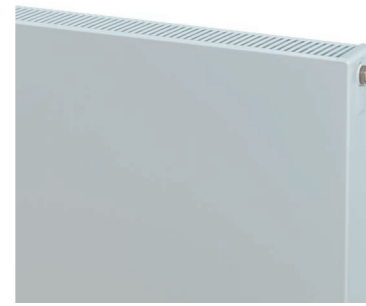

- Smooth plain front with double flat panels and double convectors
- Steel flat panel radiator available in 4 heights and 12 widths
- Standard white RAL 9016 delivered in 48-72 hours
- 23 RAL colours, 10 special finishes, up to 10 working days (pg.12-13)

## Sizes and Prices

Please add 10% to the RAL colour price to work out your special finish price.

Height	Dimensions (mm)			Output Δt 50°C		Product Code	White Ex VAT	White Inc VAT	RAL Colour Ex VAT	RAL Colour Inc VAT	White +Valves Ex VAT	White +Valves Inc VAT	RAL Colour +Valves Ex VAT	RAL Colour +Valves Inc VAT
	Width	Depth	Watts	Btu's										
300	800	102	758	2586	FARA308022	£253.00	£303.60	£571.00	£685.20	£321.00	£385.20	£639.00	£766.80	
	1000	102	948	3235	FARA301022	£301.00	£361.20	£593.00	£711.60	£369.00	£442.80	£661.00	£793.20	
	1200	102	1138	3883	FARA301222	£351.00	£421.20	£670.00	£804.00	£419.00	£502.80	£738.00	£885.60	
	1400	102	1327	4528	FARA301422	£411.00	£493.20	£749.00	£898.80	£479.00	£574.80	£817.00	£980.40	
	1600	102	1517	5176	FARA301622	£453.00	£543.60	£835.00	£1,002.00	£521.00	£625.20	£903.00	£1,083.60	
	1800	102	1706	5821	FARA301822	£501.00	£601.20	£929.00	£1,114.80	£569.00	£682.80	£997.00	£1,196.40	
400	400	102	475	1621	FARA404022	£183.00	£219.60	£429.00	£514.80	£251.00	£301.20	£497.00	£596.40	
	600	102	712	2429	FARA406022	£208.00	£249.60	£495.00	£594.00	£276.00	£331.20	£563.00	£675.60	
	800	102	950	3241	FARA408022	£248.00	£297.60	£549.00	£658.80	£316.00	£379.20	£617.00	£740.40	
	900	102	1068	3644	FARA409022	£273.00	£327.60	£609.00	£730.80	£341.00	£409.20	£677.00	£812.40	
	1000	102	1187	4050	FARA401022	£305.00	£366.00	£617.00	£740.40	£373.00	£447.60	£685.00	£822.00	
	1200	102	1424	4859	FARA401222	£361.00	£433.20	£672.00	£806.40	£429.00	£514.80	£740.00	£888.00	
	1400	102	1662	5671	FARA401422	£408.00	£489.60	£810.00	£972.00	£476.00	£571.20	£878.00	£1,053.60	
	1600	102	1899	6479	FARA401622	£470.00	£564.00	£896.00	£1,075.20	£538.00	£645.60	£964.00	£1,156.80	
	1800	102	2137	7291	FARA401822	£507.00	£608.40	£1,055.00	£1,266.00	£575.00	£690.00	£1,123.00	£1,347.60	
	2000	102	2374	8100	FARA402022	£577.00	£692.40	£1,121.00	£1,345.20	£645.00	£774.00	£1,189.00	£1,426.80	
500	400	102	566	1931	FARA504022	£206.00	£247.20	£442.00	£530.40	£274.00	£328.80	£510.00	£612.00	
	600	102	848	2893	FARA506022	£226.00	£271.20	£546.00	£655.20	£294.00	£352.80	£614.00	£736.80	
	800	102	1131	3859	FARA508022	£277.00	£332.40	£620.00	£744.00	£345.00	£414.00	£688.00	£825.60	
	1000	102	1414	4825	FARA501022	£348.00	£417.60	£683.00	£819.60	£416.00	£499.20	£751.00	£901.20	
	1200	102	1697	5790	FARA501222	£405.00	£486.00	£813.00	£975.60	£473.00	£567.60	£881.00	£1,057.20	
	1400	102	1980	6756	FARA501422	£470.00	£564.00	£967.00	£1,160.40	£538.00	£645.60	£1,035.00	£1,242.00	
	1600	102	2262	7718	FARA501622	£534.00	£640.80	£1,074.00	£1,288.80	£602.00	£722.40	£1,142.00	£1,370.40	
	1800	102	2545	8684	FARA501822	£605.00	£726.00	£1,213.00	£1,455.60	£673.00	£807.60	£1,281.00	£1,537.20	
600	400	102	652	2225	FARA604022	£230.00	£276.00	£505.00	£606.00	£298.00	£357.60	£573.00	£687.60	
	600	102	979	3340	FARA606022	£248.00	£297.60	£599.00	£718.80	£316.00	£379.20	£667.00	£800.40	
	700	102	1142	3897	FARA607022	£289.00	£346.80	£649.00	£778.80	£357.00	£428.40	£717.00	£860.40	
	800	102	1305	4453	FARA608022	£320.00	£384.00	£668.00	£801.60	£388.00	£465.60	£736.00	£883.20	
	900	102	1468	5009	FARA609022	£360.00	£432.00	£736.00	£883.20	£428.00	£513.60	£804.00	£964.80	
	1000	102	1631	5565	FARA601022	£402.00	£482.40	£780.00	£936.00	£470.00	£564.00	£848.00	£1,017.60	
	1100	102	1794	6121	FARA601122	£441.00	£529.20	£867.00	£1,040.40	£509.00	£610.80	£935.00	£1,122.00	
	1200	102	1957	6677	FARA601222	£481.00	£577.20	£922.00	£1,106.40	£549.00	£658.80	£990.00	£1,188.00	
	1400	102	2283	7790	FARA601422	£562.00	£674.40	£1,169.00	£1,402.80	£630.00	£756.00	£1,237.00	£1,484.40	
	1600	102	2610	8905	FARA601622	£629.00	£754.80	£1,268.00	£1,521.60	£697.00	£836.40	£1,336.00	£1,603.20	
600	1800	102	2936	10018	FARA601822	£693.00	£831.60	£1,421.00	£1,705.20	£761.00	£913.20	£1,489.00	£1,786.80	
	2000	102	3262	11130	FARA602022	£783.00	£939.60	£1,579.00	£1,894.80	£851.00	£1,021.20	£1,647.00	£1,976.40	

\*+Valves Prices include a choice of either Chrome or White, angled KINGSTON TRVs, (if you require straight valves please specify).

### Pipe Centres and Technical Drawings

#### Type 22 (K2) Profile

Double steel panels (one front, one back) with double convectors.

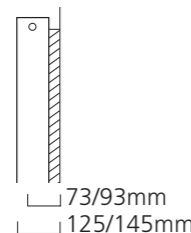

Pipe centres left to right = Width plus valves  
 Pipe centres from wall = 73 / 93mm  
 Depth from wall = 125 / 145mm

© FARADAY is a registered trademark of IRSAP UK Limited.



+Valves Prices include angled chrome or white KINGSTON TRVs.



Please specify at time of order

♦FARADAY® Type 22 (K2) 500mm x 1000mm in RAL 7016 Anthracite Grey with nickel KINGSTON TRVs & matching Pipe Covers & Shrouds.



# FARADAY® Type 21 (P+)



- Smooth plain front with double flat panels and a single convector
- Steel flat panel radiator available in 1 height and 10 widths
- Standard white RAL 9016 delivered in 48-72 hours
- 23 RAL colours, 10 special finishes, up to 10 working days (pg.12-13)

## Sizes and Prices

Please add 10% to the RAL colour price to work out your special finish price.

Dimensions (mm)			Output Δt 50°C		Product Code	White Ex VAT	White Inc VAT	RAL Colour Ex VAT	RAL Colour Inc VAT	White +Valves Ex VAT	White +Valves Inc VAT	RAL Colour +Valves Ex VAT	RAL Colour +Valves Inc VAT
Height	Width	Depth	Watts	Btu's									
600	400	68	489	1668	FARA604021	£163.00	£195.60	£336.00	£403.20	£231.00	£277.20	£404.00	£484.80
	500	68	611	2085	FARA605021	£189.00	£226.80	£365.00	£438.00	£257.00	£308.40	£433.00	£519.60
	600	68	733	2501	FARA606021	£242.00	£290.40	£541.00	£649.20	£310.00	£372.00	£609.00	£730.80
	800	68	978	3337	FARA608021	£308.00	£369.60	£603.00	£723.60	£376.00	£451.20	£671.00	£805.20
	1000	68	1222	4169	FARA601021	£373.00	£447.60	£701.00	£841.20	£441.00	£529.20	£769.00	£922.80
	1100	68	1344	4586	FARA601121	£383.00	£459.60	£760.00	£912.00	£451.00	£541.20	£828.00	£993.60
	1200	68	1466	5002	FARA601221	£421.00	£505.20	£833.00	£999.60	£489.00	£586.80	£901.00	£1,081.20
	1400	68	1711	5838	FARA601421	£503.00	£603.60	£1,048.00	£1,257.60	£571.00	£685.20	£1,116.00	£1,339.20
	1600	68	1955	6670	FARA601621	£525.00	£630.00	£1,082.00	£1,298.40	£593.00	£711.60	£1,150.00	£1,380.00
1800	68	2200	7506	FARA601821	£629.00	£754.80	£1,143.00	£1,371.60	£697.00	£836.40	£1,211.00	£1,453.20	

\*+Valves Prices include a choice of either Chrome or White, angled KINGSTON TRVs, (if you require straight valves please specify).

## Pipe Centres and Technical Drawings

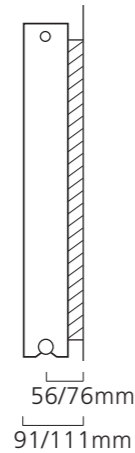
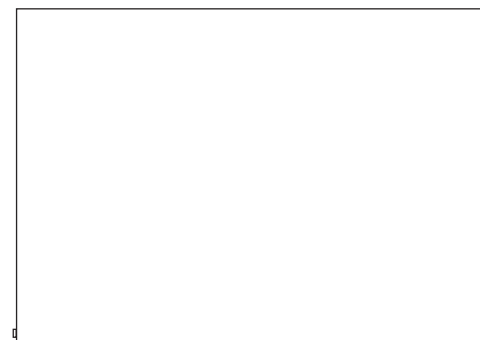

### Type 21 (P+) Profile

Double steel panels (one front, one back) with a single convector.



Pipe centres left to right = Width plus valves  
 Pipe centres from wall = 56 / 76mm  
 Depth from wall = 91 / 111mm

© FARADAY is a registered trademark of IRSAP UK Limited.

23 RAL Colours & 10 special finishes available (see pages 12-13 for full RAL and Special Finish options).

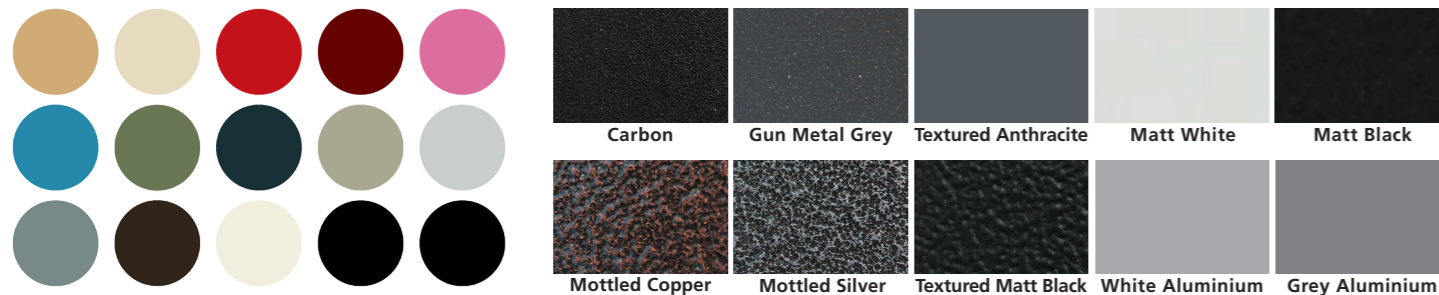

Please add 10% to the RAL Colour price to work out your Special Finish price.

Please note: Due to printing processes & manufacturing tolerances the colour of finished radiators may vary from the colours represented in this brochure.



♦ FARADAY® Type 21 (P+) 600mm x 600mm in RAL 7042 Traffic Grey A shown with nickel KINGSTON TRVs & matching Pipe Covers & Shrouds.



# FARADAY® Type 21 (P+)



- Smooth plain front with double flat panels and a single convector
- Steel flat panel radiator available in 3 heights and 3 widths
- Standard white RAL 9016 delivered in 48-72 hours
- 23 RAL colours, 10 special finishes, up to 10 working days (pg.12-13)



## Sizes and Prices

Please add 10% to the RAL colour price to work out your special finish price.

Dimensions (mm)			Output Δt 50°C		Product Code	White Ex VAT	White Inc VAT	RAL Colour Ex VAT	RAL Colour Inc VAT	White +Valves Ex VAT	White +Valves Inc VAT	RAL Colour +Valves Ex VAT	RAL Colour +Valves Inc VAT
Height	Width	Depth	Watts	Btu's									
1600	400	79	1128	3849	FARA164021	£707.00	£848.40	£1,214.00	£1,456.80	£775.00	£930.00	£1,282.00	£1,538.40
	500	79	1410	4811	FARA165021	£770.00	£924.00	£1,313.00	£1,575.60	£838.00	£1,005.60	£1,381.00	£1,657.20
	600	79	1692	5773	FARA166021 ♦	£813.00	£975.60	£1,429.00	£1,714.80	£881.00	£1,057.20	£1,497.00	£1,796.40
1800	400	79	1231	4200	FARA184021	£771.00	£925.20	£1,324.00	£1,588.80	£839.00	£1,006.80	£1,392.00	£1,670.40
	500	79	1539	5251	FARA185021	£869.00	£1,042.80	£1,484.00	£1,780.80	£937.00	£1,124.40	£1,552.00	£1,862.40
	600	79	1847	6302	FARA186021	£912.00	£1,094.40	£1,602.00	£1,922.40	£980.00	£1,176.00	£1,670.00	£2,004.00
2000	400	79	1322	4511	FARA204021	£835.00	£1,002.00	£1,592.00	£1,910.40	£903.00	£1,083.60	£1,660.00	£1,992.00
	500	79	1653	5640	FARA205021	£929.00	£1,114.80	£1,742.00	£2,090.40	£997.00	£1,196.40	£1,810.00	£2,172.00
	600	79	1983	6766	FARA206021	£1,012.00	£1,214.40	£1,932.00	£2,318.40	£1,080.00	£1,296.00	£2,000.00	£2,400.00

\*+Valves Prices include a choice of either chrome or white, straight KINGSTON TRVs, (if you require angled valves please specify).

## Pipe Centres and Technical Drawings

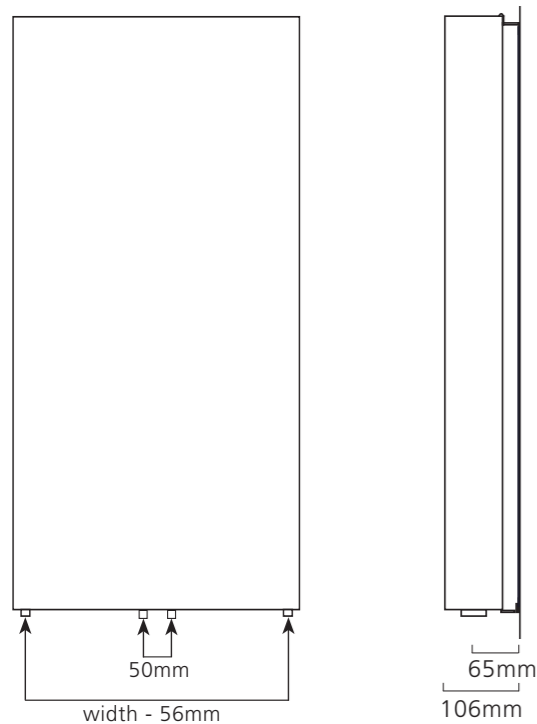

### Type 21 (P+) Profile

Double steel panels (one front, one back) with a single convector.



Pipe centres left to right	=	width minus 56mm or 50mm
Pipe centres from wall	=	65mm
Depth from wall	=	106mm

© FARADAY is a registered trademark of IRSAP UK Limited.

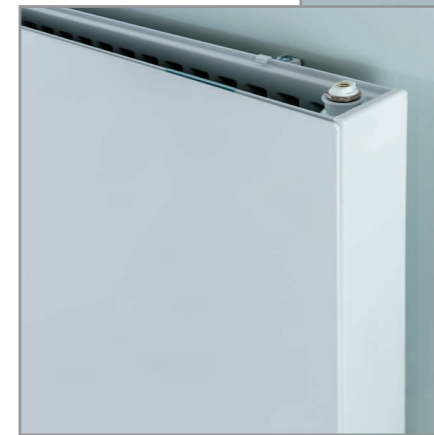

FARADAY® Type 21 (P+) Vertical profile

+Valves Prices include straight chrome or white KINGSTON TRVs



Please specify at time of order



FARADAY® Type 22 (K2) in RAL 7016 Anthracite Grey



♦ FARADAY® Type 21 (P+) Vertical 1600mm x 600mm in White RAL 9016 shown with WELLINGTON TRVs.



# WITTON Type 11

- Grooved front with a single flat panel and a single convector
- Steel flat panel radiator available in 3 heights and up to 9 widths
- Standard white RAL 9016 delivered in 48-72 hours
- 23 RAL colours, 10 special finishes, up to 10 working days (pg.12-13)



## Sizes and Prices

Please add 10% to the RAL colour price to work out your special finish price.

Dimensions (mm)			Output Δt 50°C		Product Code	White Ex VAT	White Inc VAT	RAL Colour Ex VAT	RAL Colour Inc VAT	White +Valves Ex VAT	White +Valves Inc VAT	RAL Colour +Valves Ex VAT	RAL Colour +Valves Inc VAT
Height	Width	Depth	Watts	Btu's									
400	800	65	542	1849	WITT408011	£148.00	£177.60	£285.00	£342.00	£216.00	£259.20	£353.00	£423.60
	1000	65	678	2313	WITT401011	£177.00	£212.40	£316.00	£379.20	£245.00	£294.00	£384.00	£460.80
	1200	65	814	2777	WITT401211	£206.00	£247.20	£342.00	£410.40	£274.00	£328.80	£410.00	£492.00
500	400	65	327	1116	WITT504011	£90.00	£108.00	£230.00	£276.00	£158.00	£189.60	£298.00	£357.60
	600	65	491	1675	WITT506011	£125.00	£150.00	£261.00	£313.20	£193.00	£231.60	£329.00	£394.80
	800	65	654	2231	WITT508011	£153.00	£183.60	£292.00	£350.40	£221.00	£265.20	£360.00	£432.00
	1000	65	818	2791	WITT501011	£183.00	£219.60	£320.00	£384.00	£251.00	£301.20	£388.00	£465.60
600	1200	65	982	3351	WITT501211	£214.00	£256.80	£374.00	£448.80	£282.00	£338.40	£442.00	£530.40
	400	65	381	1300	WITT604011	£105.00	£126.00	£242.00	£290.40	£173.00	£207.60	£310.00	£372.00
	600	65	572	1952	WITT606011	£135.00	£162.00	£273.00	£327.60	£203.00	£243.60	£341.00	£409.20
	700	65	667	2276	WITT607011	£156.00	£187.20	£293.00	£351.60	£224.00	£268.80	£361.00	£433.20
	800	65	762	2600	WITT608011	£174.00	£208.80	£313.00	£375.60	£242.00	£290.40	£381.00	£457.20
	900	65	858	2927	WITT609011	£193.00	£231.60	£340.00	£408.00	£261.00	£313.20	£408.00	£489.60
	1000	65	953	3252	WITT601011	£213.00	£255.60	£373.00	£447.60	£281.00	£337.20	£441.00	£529.20
	1100	65	1048	3576	WITT601111	£234.00	£280.80	£407.00	£488.40	£302.00	£362.40	£475.00	£570.00
600	1200	65	1144	3903	WITT601211	£246.00	£295.20	£435.00	£522.00	£314.00	£376.80	£503.00	£603.60
	1400	65	1334	4552	WITT601411	£294.00	£352.80	£508.00	£609.60	£362.00	£434.40	£576.00	£691.20

\*+Valves Prices include a choice of either chrome or white, angled KINGSTON TRVs, (if you require straight valves please specify).

## Pipe Centres and Technical Drawings

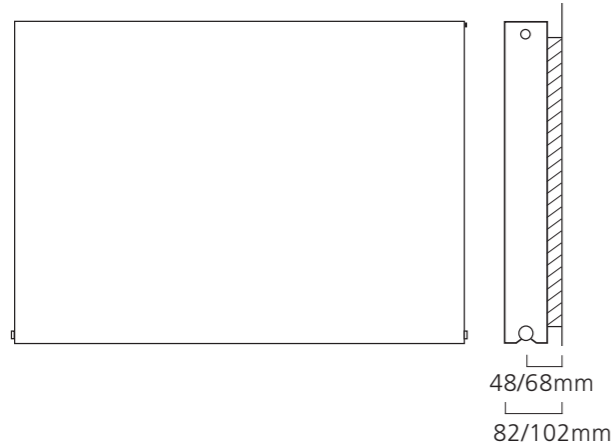

### WITTON Type 11 (K1) Profile

Single steel panel with a single convector.



Pipe centres left to right = Width plus valves  
 Pipe centres from wall = 48mm / 68mm  
 Depth from wall = 82mm / 102mm

23 RAL Colours & 10 special finishes available (see pages 12-13 for full RAL and Special Finish options).

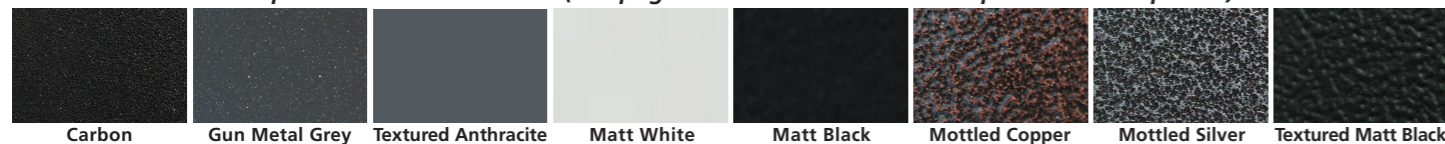

Please note: Due to printing processes & manufacturing tolerances the colour of finished radiators may vary from the colours represented in this brochure.



+Valves Prices include angled chrome or white KINGSTON TRVs

Please specify at time of order

♦ WITTON Type 11 (K1) 600mm x 1000mm in White RAL 9016 shown with white KINGSTON TRVs & matching pipe covers & shrouds.



# WITTON Type 22

- Grooved front with double flat panels and double convectors
- Steel flat panel radiator available in 3 heights and up to 10 widths
- Standard white RAL 9016 delivered in 48-72 hours
- 23 RAL colours, 10 special finishes, up to 10 working days (pg.12-13)



## Sizes and Prices

Please add 10% to the RAL colour price to work out your special finish price.

Dimensions (mm)			Output Δt 50°C		Product Code	White Ex VAT	White Inc VAT	RAL Colour Ex VAT	RAL Colour Inc VAT	White +Valves Ex VAT	White +Valves Inc VAT	RAL Colour +Valves Ex VAT	RAL Colour +Valves Inc VAT
Height	Width	Depth	Watts	Btu's									
400	800	102	950	3241	WITT408022	£239.00	£286.80	£411.00	£493.20	£307.00	£368.40	£479.00	£574.80
	1000	102	1187	4050	WITT401022	£289.00	£346.80	£462.00	£554.40	£357.00	£428.40	£530.00	£636.00
	1200	102	1424	4859	WITT401222	£342.00	£410.40	£519.00	£622.80	£410.00	£492.00	£587.00	£704.40
500	800	102	1131	3859	WITT508022	£250.00	£300.00	£423.00	£507.60	£318.00	£381.60	£491.00	£589.20
	1000	102	1414	4825	WITT501022	£305.00	£366.00	£479.00	£574.80	£373.00	£447.60	£547.00	£656.40
	1200	102	1697	5790	WITT501222	£362.00	£434.40	£565.00	£678.00	£430.00	£516.00	£633.00	£759.60
	1400	102	1980	6756	WITT501422	£421.00	£505.20	£654.00	£784.80	£489.00	£586.80	£722.00	£866.40
600	400	102	652	2225	WITT604022	£161.00	£193.20	£331.00	£397.20	£229.00	£274.80	£399.00	£478.80
	600	102	979	3340	WITT606022 ♦	£216.00	£259.20	£387.00	£464.40	£284.00	£340.80	£455.00	£546.00
	700	102	1142	3897	WITT607022	£255.00	£306.00	£426.00	£511.20	£323.00	£387.60	£494.00	£592.80
	800	102	1305	4453	WITT608022	£288.00	£345.60	£461.00	£553.20	£356.00	£427.20	£529.00	£634.80
	900	102	1468	5009	WITT609022	£319.00	£382.80	£503.00	£603.60	£387.00	£464.40	£571.00	£685.20
	1000	102	1631	5565	WITT601022	£352.00	£422.40	£555.00	£666.00	£420.00	£504.00	£623.00	£747.60
	1100	102	1794	6121	WITT601122	£399.00	£478.80	£620.00	£744.00	£467.00	£560.40	£688.00	£825.60
	1200	102	1957	6677	WITT601222	£415.00	£498.00	£652.00	£782.40	£483.00	£579.60	£720.00	£864.00
	1400	102	2283	7790	WITT601422	£494.00	£592.80	£768.00	£921.60	£562.00	£674.40	£836.00	£1,003.20
1600	102	2610	8905	WITT601622	£557.00	£668.40	£864.00	£1,036.80	£625.00	£750.00	£932.00	£1,118.40	

\*+Valves Prices include a choice of either chrome or white, angled KINGSTON TRVs, (if you require straight valves please specify).

## Pipe Centres and Technical Drawings

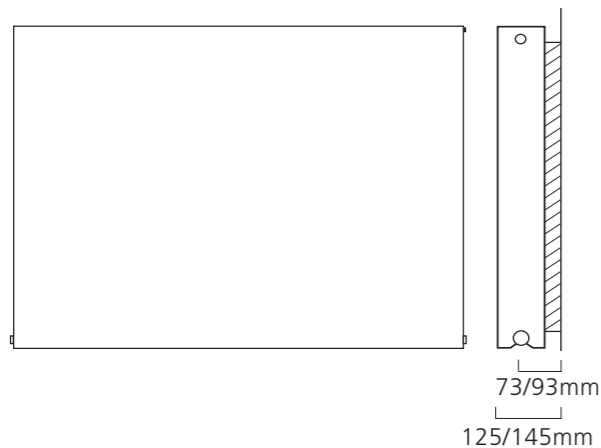

### WITTON Type 22 (K2) Profile

Double steel panels (one front, one back) with double convectors.



Pipe centres left to right	=	Width plus valves
Pipe centres from wall	=	73 / 93mm
Depth from wall	=	125 / 145mm

23 RAL Colours & 10 special finishes available (see pages 12-13 for full RAL and Special Finish options).



Please note: Due to printing processes & manufacturing tolerances the colour of finished radiators may vary from the colours represented in this brochure.



♦ WITTON Type 22 (K2) 600mm x 600mm in White RAL 9016 shown with white KINGSTON TRVs & matching pipe covers & shrouds.



# SAXON Horizontal

- Italian design & manufacture, aluminium radiator
- Combines low water content with high thermal efficiency
- Standard white RAL 9010 delivered in 48-72 hours
- 23 RAL colours, 10 special finishes, up to 10 working days (pg.12-13)



## Sizes and Prices

Please add 10% to the RAL colour price to work out your special finish price.

Dimensions (mm)			Sections	Output Δt 50°C		Product Code	White Ex VAT	White Inc VAT	RAL Colour Ex VAT	RAL Colour Inc VAT	White +Valves Ex VAT	White +Valves Inc VAT	RAL Colour +Valves Ex VAT	RAL Colour +Valves Inc VAT
Height	Width	Depth		Watts	Btu's									
440	420	95	5	470	1604	SAXO444205H	£194.00	£232.80	£288.00	£345.60	£262.00	£314.40	£356.00	£427.20
	660	95	8	752	2566	SAXO446608H	£263.00	£315.60	£418.00	£501.60	£331.00	£397.20	£486.00	£583.20
	820	95	10	940	3207	SAXO448210H	£328.00	£393.60	£523.00	£627.60	£396.00	£475.20	£591.00	£709.20
	980	95	12	1128	3849	SAXO449812H	£392.00	£470.40	£625.00	£750.00	£460.00	£552.00	£693.00	£831.60
	1140	95	14	1316	4490	SAXO441114H	£484.00	£580.80	£730.00	£876.00	£552.00	£662.40	£798.00	£957.60
590	420	95	5	615	2098	SAXO594205H	£198.00	£237.60	£297.00	£356.40	£266.00	£319.20	£365.00	£438.00
	660	95	8	984	3357	SAXO596608H	£264.00	£316.80	£426.00	£511.20	£332.00	£398.40	£494.00	£592.80
	820	95	10	1230	4197	SAXO598210H	£332.00	£398.40	£531.00	£637.20	£400.00	£480.00	£599.00	£718.80
	980	95	12	1476	5036	SAXO599812H	£394.00	£472.80	£640.00	£768.00	£462.00	£554.40	£708.00	£849.60
	1140	95	14	1722	5875	SAXO591114H	£496.00	£595.20	£747.00	£896.40	£564.00	£676.80	£815.00	£978.00
690	420	95	5	710	2423	SAXO694205H	£207.00	£248.40	£302.00	£362.40	£275.00	£330.00	£370.00	£444.00
	660	95	8	1136	3876	SAXO696608H	£277.00	£332.40	£441.00	£529.20	£345.00	£414.00	£509.00	£610.80
	820	95	10	1420	4845	SAXO698210H	£348.00	£417.60	£553.00	£663.60	£416.00	£499.20	£621.00	£745.20
	980	95	12	1704	5814	SAXO699812H	£419.00	£502.80	£662.00	£794.40	£487.00	£584.40	£730.00	£876.00
	1140	95	14	1988	6783	SAXO691114H	£519.00	£622.80	£771.00	£925.20	£587.00	£704.40	£839.00	£1,006.80

Please note widths include measurement for bushes.

\*+Valves Prices include a choice of either chrome or white, angled KINGSTON TRVs, (if you require straight valves please specify).

## Pipe Centres and Technical Drawings

Side Profile    Front Profile

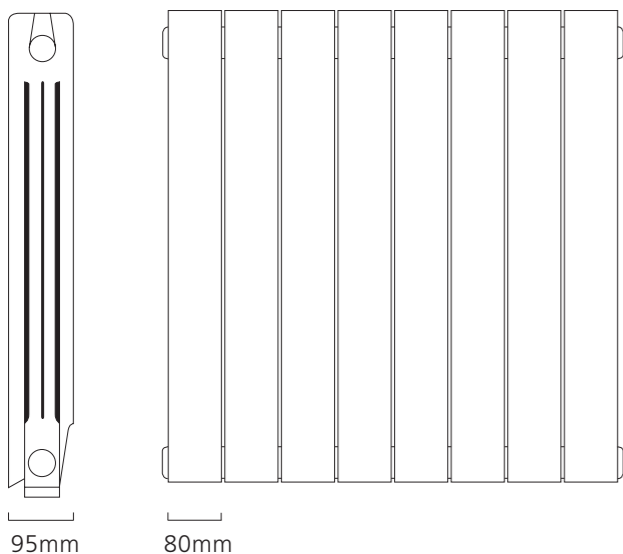

Pipe centres left to right = Width of radiator plus valves  
 Pipe centres from wall = 70mm  
 Depth from wall = 120mm

### Wall Brackets

Each SAXON radiator will be supplied with 2 x left hand and 2 x right hand Brackets.

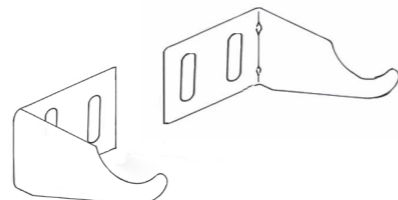

For a larger range of aluminium please refer to The Radiator Company; [theradiatorcompany.co.uk](http://theradiatorcompany.co.uk) where we have an extensive range of sizes.



+Valves Prices include angled chrome or white KINGSTON TRVs

Please specify at time of order

◆ SAXON Horizontal 690mm x 980mm shown in special finish Gun Metal Grey with nickel KINGSTON TRVs.



# SAXON Vertical

- Italian design & manufacture, aluminium radiator
- Combines low water content with high thermal efficiency
- Standard white RAL 9010 delivered in 48-72 hours
- 23 RAL colours, 10 special finishes, up to 10 working days (pg.12-13)



## Sizes and Prices

Please add 10% to the RAL colour price to work out your special finish price.

Height	Dimensions (mm)			Output Δt 50°C		Product Code	White Ex VAT	White Inc VAT	RAL Colour Ex VAT	RAL Colour Inc VAT	White +Valves Ex VAT	White +Valves Inc VAT	RAL Colour +Valves Ex VAT	RAL Colour +Valves Inc VAT
	Width	Depth	Sections	Watts	Btu's									
1446	260	95	3	735	2508	SAXO142603V	£341.00	£409.20	£468.00	£561.60	£409.00	£490.80	£536.00	£643.20
	340	95	4	980	3344	SAXO143404V	£452.00	£542.40	£605.00	£726.00	£520.00	£624.00	£673.00	£807.60
	420	95	5	1225	4180	SAXO144205V	£568.00	£681.60	£756.00	£907.20	£636.00	£763.20	£824.00	£988.80
	500	95	6	1470	5016	SAXO145006V	£682.00	£818.40	£906.00	£1,087.20	£750.00	£900.00	£974.00	£1,168.80
1846	260	95	3	891	3040	SAXO182603V	£424.00	£508.80	£549.00	£658.80	£492.00	£590.40	£617.00	£740.40
	340	95	4	1188	4053	SAXO183404V	£561.00	£673.20	£733.00	£879.60	£629.00	£754.80	£801.00	£961.20
	420	95	5	1485	5067	SAXO184205V	£704.00	£844.80	£913.00	£1,095.60	£772.00	£926.40	£981.00	£1,177.20
	500	95	6	1782	6080	SAXO185006V	£843.00	£1,011.60	£1,097.00	£1,316.40	£911.00	£1,093.20	£1,165.00	£1,398.00

Please note widths include measurement for bushes.

\*+Valves Prices include a choice of either chrome or white, angled KINGSTON TRVs, (if you require straight valves please specify).

## Pipe Centres and Technical Drawings

Side Profile      Front Profile

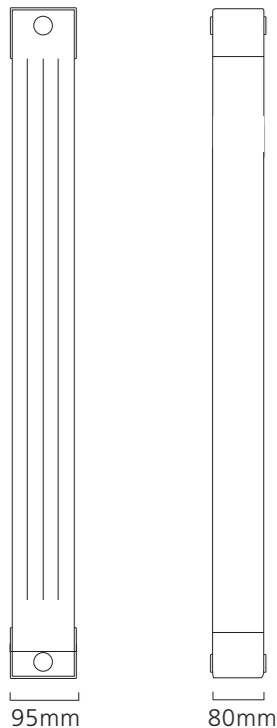

Pipe centres left to right = Width of radiator plus valves  
 Pipe centres from wall = 70mm  
 Depth from wall = 120mm

### Wall Brackets

Each SAXON radiator will be supplied with 2 x left hand and 2 x right hand Brackets.

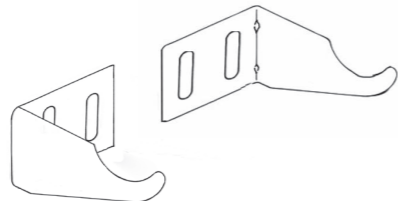

For a larger range of aluminium please refer to The Radiator Company; [theradiatorcompany.co.uk](http://theradiatorcompany.co.uk) where we have an extensive range of sizes.



SAXON shown in Gun Metal Grey

+Valves Prices include angled chrome or white KINGSTON TRVs.



Please specify at time of order



SAXON White Hanging Bar (pg.97)



◆ SAXON Vertical 1846mm x 500mm in White RAL 9010 shown with WELLINGTON TRVs.



# HUXLEY

- Italian design & manufacture, aluminium radiator
- Combines low water content with high thermal efficiency
- Standard textured matt white RAL 9016 delivered in 48-72 hours
- 23 RAL colours, 10 special finishes, up to 10 working days (pg.12-13)

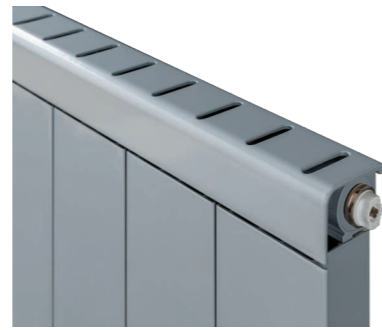

## Sizes and Prices

Please add 10% to the RAL colour price to work out your special finish price.

Dimensions (mm)		Elements	Output Δt 50°C		Product Code	White Ex VAT	White Inc VAT	RAL Colour Ex VAT	RAL Colour Inc VAT	White +Valves Ex VAT	White +Valves Inc VAT	RAL Colour +Valves Ex VAT	RAL Colour +Valves Inc VAT
Height	Width		Watts	Btu's									
<b>Horizontal</b>													
548	800	8	626	2136	HUXL548008H	£394.00	£472.80	£514.00	£616.80	£462.00	£554.40	£582.00	£698.40
	1000	10	782	2668	HUXL541010H	£482.00	£578.40	£623.00	£747.60	£550.00	£660.00	£691.00	£829.20
	1200	12	938	3200	HUXL541212H	£591.00	£709.20	£746.00	£895.20	£659.00	£790.80	£814.00	£976.80
	1400	14	1095	3736	HUXL541414H	£690.00	£828.00	£865.00	£1,038.00	£758.00	£909.60	£933.00	£1,119.60
648	800	8	725	2474	HUXL648008H	£422.00	£506.40	£546.00	£655.20	£490.00	£588.00	£614.00	£736.80
	1000	10	906	3091	HUXL641010H	£520.00	£624.00	£679.00	£814.80	£588.00	£705.60	£747.00	£896.40
	1200	12	1087	3709	HUXL641212H	£634.00	£760.80	£811.00	£973.20	£702.00	£842.40	£879.00	£1,054.80
	1400	14	1268	4326	HUXL641414H	£738.00	£885.60	£943.00	£1,131.60	£806.00	£967.20	£1,011.00	£1,213.20
<b>Vertical</b>													
1848	300	3	691	2358	HUXL183003V	£299.00	£358.80	£415.00	£498.00	£367.00	£440.40	£483.00	£579.60
	400	4	921	3142	HUXL184004V	£398.00	£477.60	£547.00	£656.40	£466.00	£559.20	£615.00	£738.00
	500	5	1151	3927	HUXL185005V	£498.00	£597.60	£679.00	£814.80	£566.00	£679.20	£747.00	£896.40
	600	6	1381	4712	HUXL186006V	£597.00	£716.40	£812.00	£974.40	£665.00	£798.00	£880.00	£1,056.00

\*+Valves Prices include a choice of either chrome or white, angled KINGSTON TRVs, (if you require straight valves please specify).

## Pipe Centres and Technical Drawings

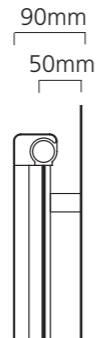
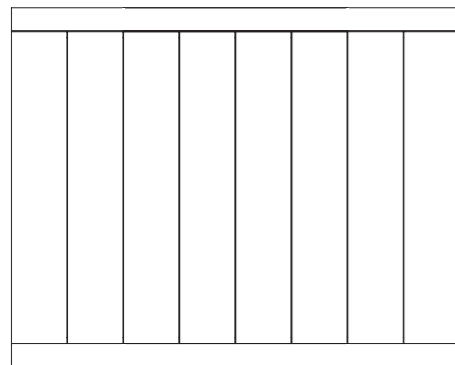

Top view



Pipe centres left to right = Width - 22mm plus valves  
 Pipe centres from wall = 50mm  
 Depth from wall = 90mm

23 RAL Colours & 10 special finishes available (see pages 12-13 for full RAL and Special Finish options).

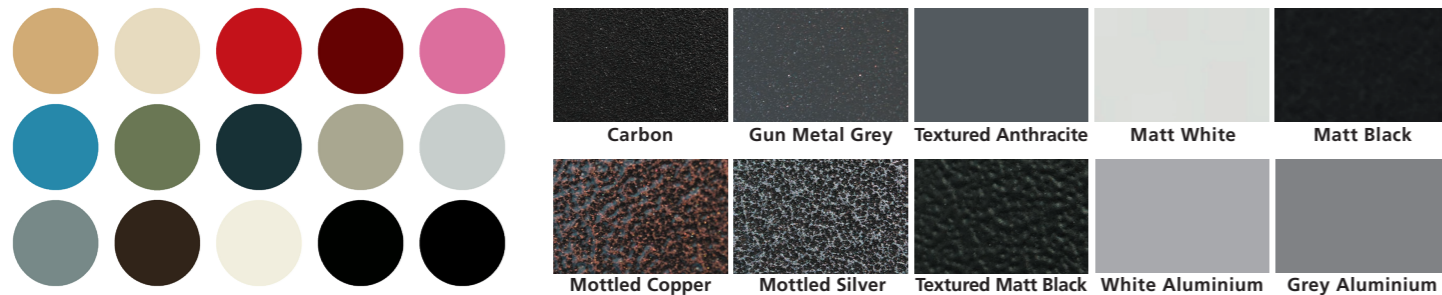

Please add 10% to the RAL Colour price to work out your Special Finish price.

Please note: Due to printing processes & manufacturing tolerances the colour of finished radiators may vary from the colours represented in this brochure.

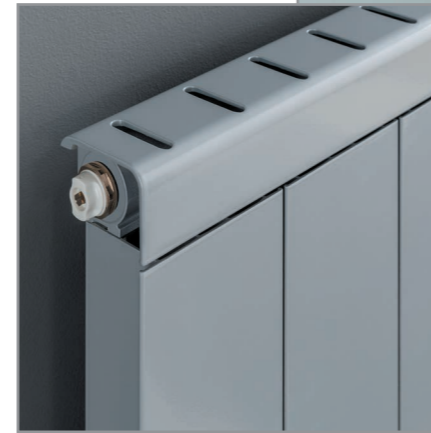

HUXLEY profile

+Valves Prices include angled chrome or white KINGSTON TRVs



Please specify at time of order



Horizontal in White Aluminium



◆ HUXLEY Vertical 1848mm x 400mm in White RAL 9016 with WELLINGTON TRVs.



# PAXTON

- Italian design & manufacture, aluminium radiator
- Combines low water content with high thermal efficiency
- Standard textured matt white RAL 9016 delivered in 48-72 hours
- 23 RAL colours, 10 special finishes, up to 10 working days (pg.12-13)



## Sizes and Prices

Please add 10% to the RAL colour price to work out your special finish price.

Dimensions (mm)		Elements	Output Δt 50°C		Product Code	White Ex VAT	White Inc VAT	RAL Colour Ex VAT	RAL Colour Inc VAT	White +Valves Ex VAT	White +Valves Inc VAT	RAL Colour +Valves Ex VAT	RAL Colour +Valves Inc VAT
Height	Width		Watts	Btu's									
<b>Horizontal</b>													
526	790	10	1050	3583	PAXT527910H	£538.00	£645.60	£637.00	£764.40	£606.00	£727.20	£705.00	£846.00
	948	12	1260	4299	PAXT529412H	£645.00	£774.00	£743.00	£891.60	£713.00	£855.60	£811.00	£973.20
	1106	14	1470	5016	PAXT521114H	£753.00	£903.60	£863.00	£1,035.60	£821.00	£985.20	£931.00	£1,117.20
	1264	16	1680	5732	PAXT521216H	£861.00	£1,033.20	£983.00	£1,179.60	£929.00	£1,114.80	£1,051.00	£1,261.20
	1422	18	1890	6449	PAXT521418H	£968.00	£1,161.60	£1,105.00	£1,326.00	£1,036.00	£1,243.20	£1,173.00	£1,407.60
626	790	10	1222	4169	PAXT627910H	£589.00	£706.80	£689.00	£826.80	£657.00	£788.40	£757.00	£908.40
	948	12	1466	5002	PAXT629412H	£707.00	£848.40	£821.00	£985.20	£775.00	£930.00	£889.00	£1,066.80
	1106	14	1711	5838	PAXT621114H	£824.00	£988.80	£956.00	£1,147.20	£892.00	£1,070.40	£1,024.00	£1,228.80
	1264	16	1955	6670	PAXT621216H	£941.00	£1,129.20	£1,089.00	£1,306.80	£1,009.00	£1,210.80	£1,157.00	£1,388.40
	1422	18	2200	7506	PAXT621418H	£1,060.00	£1,272.00	£1,224.00	£1,468.80	£1,128.00	£1,353.60	£1,292.00	£1,550.40
<b>Vertical</b>													
1826	316	4	1206	4115	PAXT183104V	£393.00	£471.60	£509.00	£610.80	£461.00	£553.20	£577.00	£692.40
	395	5	1507	5142	PAXT183905V	£492.00	£590.40	£632.00	£758.40	£560.00	£672.00	£700.00	£840.00
	474	6	1808	6169	PAXT184706V	£589.00	£706.80	£755.00	£906.00	£657.00	£788.40	£823.00	£987.60
	553	7	2110	7199	PAXT185507V	£688.00	£825.60	£877.00	£1,052.40	£756.00	£907.20	£945.00	£1,134.00

\*+Valves Prices include a choice of either chrome or white, angled KINGSTON TRVs, (if you require straight valves please specify).

## Pipe Centres and Technical Drawings

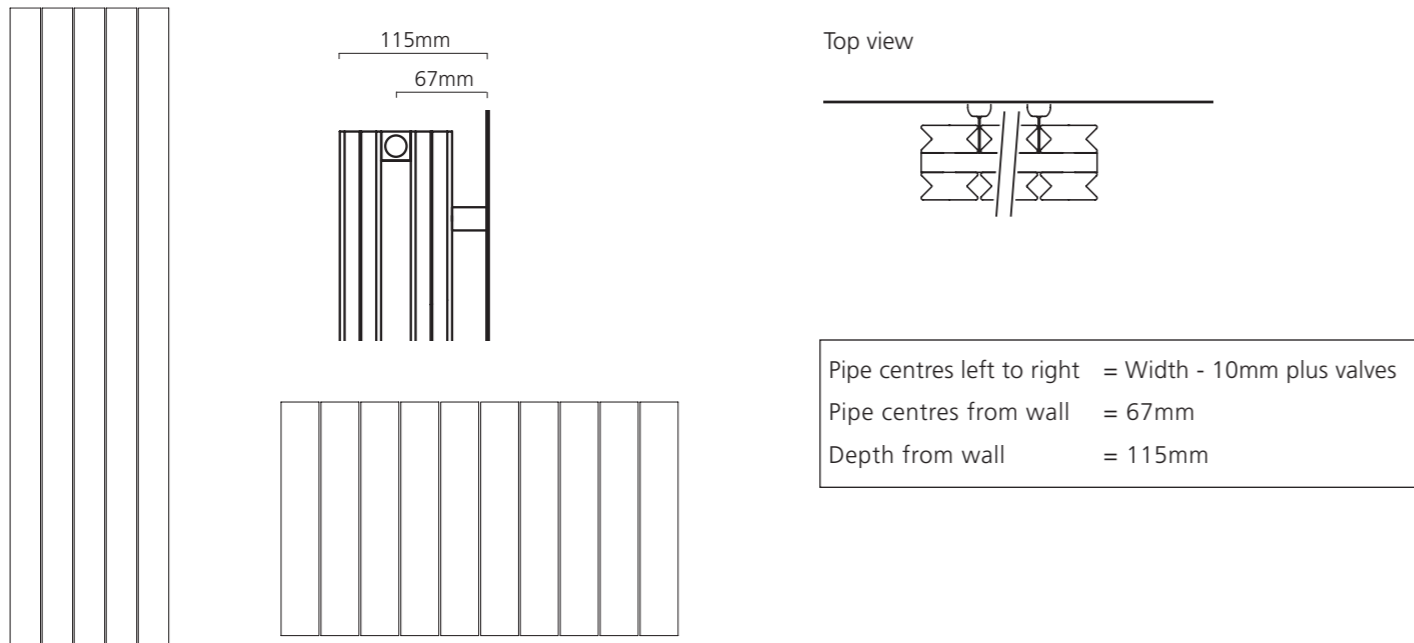

◆PAXTON Vertical 1826mm x 395mm shown in White RAL 9016 with KINGSTON TRVs.



# LARKIN

- Italian design & manufacture, horizontal or vertical configurations
- Steel radiator with 20mm x 25mm tubes & 30mm collectors
- Standard white RAL 9016 delivered in 48-72 hours
- 23 RAL colours, 10 special finishes, up to 10 working days (pg.12-13)



## Sizes and Prices

Please add 10% to the RAL colour price to work out your special finish price.

Dimensions (mm)		Elements	Output Δt 50°C		Product Code	White Ex VAT	White Inc VAT	RAL Colour Ex VAT	RAL Colour Inc VAT	White +Valves Ex VAT	White +Valves Inc VAT	RAL Colour +Valves Ex VAT	RAL Colour +Valves Inc VAT
Height	Width		Watts	Btu's									
<b>Horizontal - Single</b>													
520	1200	13	799	2726	LARK521213SH	£500.00	£600.00	£607.00	£728.40	£568.00	£681.60	£675.00	£810.00
600	900	15	686	2341	LARK609015SH	£502.00	£602.40	£626.00	£751.20	£570.00	£684.00	£694.00	£832.80
	1200	15	915	3122	LARK601215SH	£532.00	£638.40	£673.00	£807.60	£600.00	£720.00	£741.00	£889.20
<b>Horizontal - Double</b>													
520	1200	26	1272	4340	LARK521226DH	£927.00	£1,112.40	£1,026.00	£1,231.20	£995.00	£1,194.00	£1,094.00	£1,312.80
600	900	30	1066	3637	LARK609030DH	£942.00	£1,130.40	£1,056.00	£1,267.20	£1,010.00	£1,212.00	£1,124.00	£1,348.80
	1200	30	1422	4852	LARK601230DH	£990.00	£1,188.00	£1,122.00	£1,346.40	£1,058.00	£1,269.60	£1,190.00	£1,428.00
<b>Vertical - Single</b>													
1800	400	10	861	2938	LARK184010SV	£499.00	£598.80	£617.00	£740.40	£567.00	£680.40	£685.00	£822.00
	520	13	1119	3818	LARK185213SV	£572.00	£686.40	£726.00	£871.20	£640.00	£768.00	£794.00	£952.80
<b>Vertical - Double</b>													
1800	400	20	1356	4627	LARK184020DV	£914.00	£1,096.80	£1,071.00	£1,285.20	£982.00	£1,178.40	£1,139.00	£1,366.80
	520	26	1762	6012	LARK185226DV	£1,052.00	£1,262.40	£1,250.00	£1,500.00	£1,120.00	£1,344.00	£1,318.00	£1,581.60

\*\*Valves Prices include a choice of either chrome or white, angled KINGSTON TRVs, (straight valves available on request).

## Pipe Centres and Technical Drawings

Single Horizontal Double Horizontal

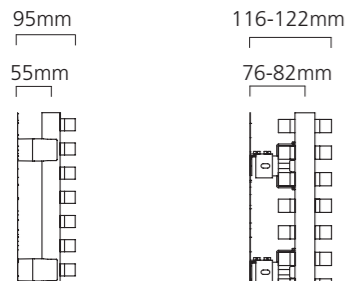

**Horizontal**  
 Pipe centres left to right = Width less 30mm  
 Pipe centres from wall = Single:55mm  
 Double:76mm-82mm  
 Depth from wall = Single:95mm  
 Double:116mm-122mm

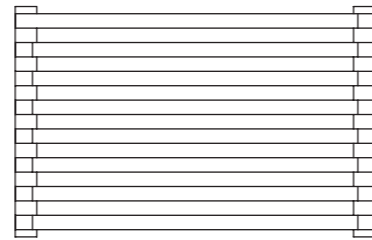

Single Vertical Double Vertical

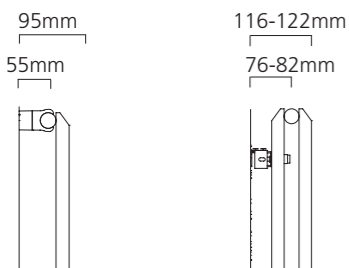

**Vertical**  
 Pipe centres left to right = Width plus valves  
 Pipe centres from wall = Single:55mm  
 Double:76mm- 82mm  
 Depth from wall = Single:95mm  
 Double:116mm-122mm

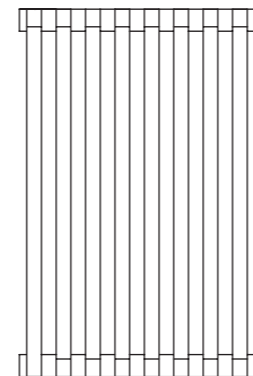

+Valves Prices include angled chrome or white KINGSTON TRVs

Please specify at time of order



Double Horizontal



Double Horizontal detail



◆LARKIN Single Vertical 1800mm x 520mm in RAL 7042 Traffic Grey A shown with nickel KINGSTON TRVs.



# BEAUFORT Max Horizontal



- Type 11 (K1) & 22 (K2) convectors cloaked in 70mm flat tubed radiators
- Steel radiator available in 3 heights & 2 widths
- Standard white RAL 9016 delivered in 48-72 hours
- 23 RAL colours, 10 special finishes, up to 10 working days (pg.12-13)



## Sizes & Prices

Please add 10% to the RAL colour price to work out your special finish price.

Dimensions (mm)		Elements	Output Δt 50°C		Product Code	White Ex VAT	White Inc VAT	RAL Colour Ex VAT	RAL Colour Inc VAT	White +Valves Ex VAT	White +Valves Inc VAT	RAL Colour +Valves Ex VAT	RAL Colour +Valves Inc VAT
Height	Width		Watts	Btu's									
<b>Horizontal - Type 11</b>													
366	1000	5	638	2177	BEAM36100511	£292.00	£350.40	£462.00	£554.40	£360.00	£432.00	£530.00	£636.00
	1200	5	766	2614	BEAM36120511	£311.00	£373.20	£482.00	£578.40	£379.00	£454.80	£550.00	£660.00
514	1000	7	848	2893	BEAM51100711	£350.00	£420.00	£531.00	£637.20	£418.00	£501.60	£599.00	£718.80
	1200	7	1018	3473	BEAM51120711	£381.00	£457.20	£580.00	£696.00	£449.00	£538.80	£648.00	£777.60
662	1000	9	1048	3576	BEAM66100911	£410.00	£492.00	£645.00	£774.00	£478.00	£573.60	£713.00	£855.60
	1200	9	1258	4292	BEAM66120911	£447.00	£536.40	£722.00	£866.40	£515.00	£618.00	£790.00	£948.00
<b>Horizontal - Type 22</b>													
366	1000	10	1207	4118	BEAM36101022	£475.00	£570.00	£712.00	£854.40	£543.00	£651.60	£780.00	£936.00
	1200	10	1448	4941	BEAM36121022	£542.00	£650.40	£749.00	£898.80	£610.00	£732.00	£817.00	£980.40
514	1000	14	1554	5302	BEAM51101422	£620.00	£744.00	£837.00	£1,004.40	£688.00	£825.60	£905.00	£1,086.00
	1200	14	1865	6363	BEAM51121422	£680.00	£816.00	£912.00	£1,094.40	£748.00	£897.60	£980.00	£1,176.00
662	1000	18	1853	6322	BEAM66101822	£749.00	£898.80	£1,011.00	£1,213.20	£817.00	£980.40	£1,079.00	£1,294.80
	1200	18	2224	7588	BEAM66121822	£816.00	£979.20	£1,127.00	£1,352.40	£884.00	£1,060.80	£1,195.00	£1,434.00

\*+Valves Prices include a choice of either chrome or white, straight KINGSTON TRVs shown right and on page 92 (if you require angled valves please specify).

## Pipe Centres and Technical Drawings



Type 11 (K1)

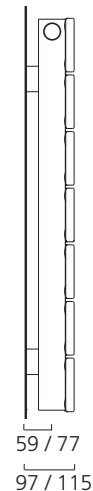

Type 22 (K2)

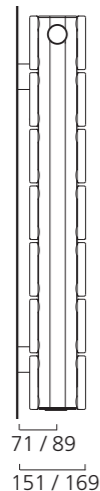

### Type 11 (K1)

Single flat tubed radiator with a single convector.



Pipe centres left to right = Width less 50mm  
 Pipe centres from wall = 59 / 77mm  
 Depth from wall = 97 / 115mm

### Type 22 (K2)

Double flat tubed radiator (front and back) with double convectors.

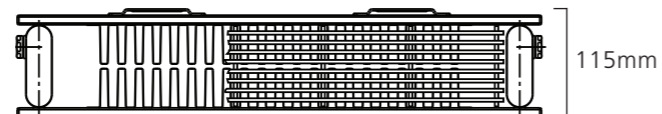

Pipe centres left to right = Width less 50mm  
 Pipe centres from wall = 71 / 89mm  
 Depth from wall = 151 / 169mm



BEAUFORT Max Type 11 (K1) Profile

◆ BEAUFORT Max Type 11 (K1) Horizontal 662mm x 1000mm shown in White RAL 9016 with white KINGSTON TRVs.



# BEAUFORT Max Vertical

- Type 11 & Type 20 profiles cloaked in 70mm flat tubed radiators
- Steel radiator available in 1 height & 4 widths
- Standard white RAL 9016 delivered in 48-72 hours
- 23 RAL colours, 10 special finishes, up to 10 working days (pg.12-13)



## Sizes & Prices

Please add 10% to the RAL colour price to work out your special finish price.

Dimensions (mm)		Elements	Output Δt 50°C		Product Code	White Ex VAT	White Inc VAT	RAL Colour Ex VAT	RAL Colour Inc VAT	White +Valves Ex VAT	White +Valves Inc VAT	RAL Colour +Valves Ex VAT	RAL Colour +Valves Inc VAT
Height	Width		Watts	Btu's									
<b>Vertical - Type 11</b>													
1800	366	5	903	3081	BEAM18360511	£357.00	£428.40	£555.00	£666.00	£425.00	£510.00	£623.00	£747.60
	514	7	1268	4326	BEAM18510711	£474.00	£568.80	£761.00	£913.20	£542.00	£650.40	£829.00	£994.80
	588	8	1450	4947	BEAM18580811	£503.00	£603.60	£846.00	£1,015.20	£571.00	£685.20	£914.00	£1,096.80
	662	9	1632	5568	BEAM18660911	£591.00	£709.20	£959.00	£1,150.80	£659.00	£790.80	£1,027.00	£1,232.40
<b>Vertical - Type 20</b>													
1800	366	10	1105	3770	BEAM18361020	£645.00	£774.00	£866.00	£1,039.20	£713.00	£855.60	£934.00	£1,120.80
	514	14	1552	5295	BEAM18511420	£849.00	£1,018.80	£1,175.00	£1,410.00	£917.00	£1,100.40	£1,243.00	£1,491.60
	588	16	1775	6056	BEAM18581620	£930.00	£1,116.00	£1,293.00	£1,551.60	£998.00	£1,197.60	£1,361.00	£1,633.20
	662	18	1999	6821	BEAM18661820	£1,048.00	£1,257.60	£1,466.00	£1,759.20	£1,116.00	£1,339.20	£1,534.00	£1,840.80

\*+Valves Prices include a choice of either chrome or white, angled KINGSTON TRVs shown right and on page 92 (if you require straight valves please specify).

+Valves Prices include angled chrome or white KINGSTON TRVs

Please specify at time of order



Horizontal (pg.50-51)

## Pipe Centres and Technical Drawings

Type 11



Type 20

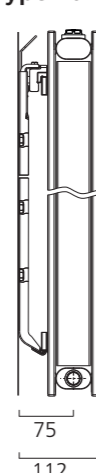

Type 11

Single flat tubed radiator with a single convector

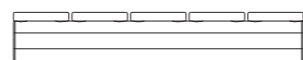

Pipe centres left to right = Width plus valves  
 Pipe centres from wall = 63mm  
 Depth from wall = 99mm

Type 20

Double flat tubed radiator (front and back)



Pipe centres left to right = Width plus valves  
 Pipe centres from wall = 75mm  
 Depth from wall = 112mm



BEAUFORT Max Vertical Type 11

◆ BEAUFORT Max Vertical Type 11 1800mm x 366mm in White RAL 9016 with white WELLINGTON TRVs.



# BEAUFORT Horizontal



- Italian design & manufacture, steel horizontal radiator
- 70mm flat tubes available in 3 heights & 2 widths in single & double
- Standard white RAL 9016 delivered in 48-72 hours
- 23 RAL colours, 10 special finishes, up to 10 working days (pg.12-13)

## Sizes and Prices

Please add 10% to the RAL colour price to work out your special finish price.

Dimensions (mm)		Elements	Output Δt 50°C		Product Code	White Ex VAT	White Inc VAT	RAL Colour Ex VAT	RAL Colour Inc VAT	White +Valves Ex VAT	White +Valves Inc VAT	RAL Colour +Valves Ex VAT	RAL Colour +Valves Inc VAT
Height	Width		Watts	Btu's									
<b>Horizontal - Single</b>													
312	1020	4	340	1160	BEAUF311004SH	£257.00	£308.40	£400.00	£480.00	£325.00	£390.00	£468.00	£561.60
	1220	4	392	1338	BEAUF311204SH	£273.00	£327.60	£417.00	£500.40	£341.00	£409.20	£485.00	£582.00
464	1020	6	501	1709	BEAUF461006SH	£308.00	£369.60	£459.00	£550.80	£376.00	£451.20	£527.00	£632.40
	1220	6	600	2047	BEAUF461206SH	£337.00	£404.40	£501.00	£601.20	£405.00	£486.00	£569.00	£682.80
616	1020	8	659	2249	BEAUF611008SH	£373.00	£447.60	£557.00	£668.40	£441.00	£529.20	£625.00	£750.00
	1220	8	789	2692	BEAUF611208SH	£409.00	£490.80	£624.00	£748.80	£477.00	£572.40	£692.00	£830.40
<b>Horizontal - Double</b>													
312	1020	8	567	1935	BEAUF311008DH	£419.00	£502.80	£614.00	£736.80	£487.00	£584.40	£682.00	£818.40
	1220	8	671	2289	BEAUF311208DH	£477.00	£572.40	£648.00	£777.60	£545.00	£654.00	£716.00	£859.20
464	1020	12	793	2706	BEAUF461012DH	£545.00	£654.00	£723.00	£867.60	£613.00	£735.60	£791.00	£949.20
	1220	12	948	3235	BEAUF461212DH	£599.00	£718.80	£788.00	£945.60	£667.00	£800.40	£856.00	£1,027.20
616	1020	16	1005	3429	BEAUF611016DH	£660.00	£792.00	£876.00	£1,051.20	£728.00	£873.60	£944.00	£1,132.80
	1220	16	1202	4101	BEAUF611216DH	£719.00	£862.80	£974.00	£1,168.80	£787.00	£944.40	£1,042.00	£1,250.40

\*+Valves Prices include a choice of either chrome or white, straight KINGSTON TRVs, (if you require angled valves please specify).

## Pipe Centres and Technical Drawings

**Single Horizontal**  
 Pipe centres left to right = Width less 58mm  
 Pipe centres from wall = 55mm - 65mm  
 Depth from wall = 79mm - 89mm

**Double Horizontal**  
 Pipe centres left to right = Width less 58mm  
 Pipe centres from wall = 67mm - 77mm  
 Depth from wall = 91mm - 101mm

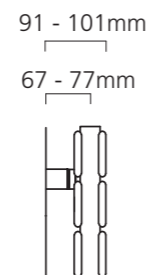
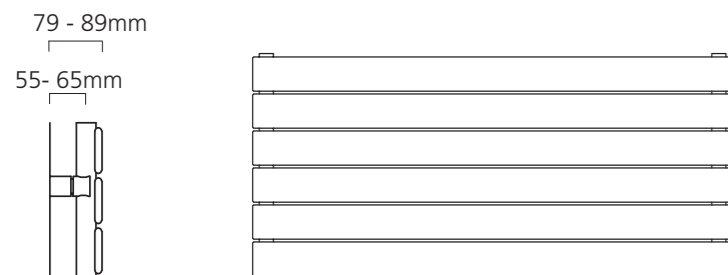

◆ BEAUFORT Double Horizontal 464mm x 1020mm shown in White RAL 9016 with white KINGSTON TRVs.



# BEAUFORT Vertical

- Italian design & manufacture, steel vertical radiator
- 70mm flat tube steel radiator available in 1 height & 4 widths
- Standard white RAL 9016 delivered in 48-72 hours
- 23 RAL colours, 10 special finishes, up to 10 working days (pg.12-13)



## Sizes and Prices

Please add 10% to the RAL colour price to work out your special finish price.

Dimensions (mm)		Elements	Output Δt 50°C		Product Code	White Ex VAT	White Inc VAT	RAL Colour Ex VAT	RAL Colour Inc VAT	White +Valves Ex VAT	White +Valves Inc VAT	RAL Colour +Valves Ex VAT	RAL Colour +Valves Inc VAT
Height	Width		Watts	Btu's									
<b>Vertical - Single</b>													
1820	312	4	588	2006	BEAUF183104SV	£315.00	£378.00	£480.00	£576.00	£383.00	£459.60	£548.00	£657.60
	464	6	881	3006	BEAUF184606SV	£418.00	£501.60	£657.00	£788.40	£486.00	£583.20	£725.00	£870.00
	540	7	1029	3511	BEAUF185407SV♦	£443.00	£531.60	£730.00	£876.00	£511.00	£613.20	£798.00	£957.60
	616	8	1176	4013	BEAUF186108SV	£522.00	£626.40	£828.00	£993.60	£590.00	£708.00	£896.00	£1,075.20
<b>Vertical - Double</b>													
1820	312	8	840	2866	BEAUF183108DV	£567.00	£680.40	£750.00	£900.00	£635.00	£762.00	£818.00	£981.60
	464	12	1259	4296	BEAUF184612DV	£748.00	£897.60	£1,016.00	£1,219.20	£816.00	£979.20	£1,084.00	£1,300.80
	540	14	1470	5016	BEAUF185414DV	£821.00	£985.20	£1,117.00	£1,340.40	£889.00	£1,066.80	£1,185.00	£1,422.00
	616	16	1680	5732	BEAUF186116DV	£924.00	£1,108.80	£1,267.00	£1,520.40	£992.00	£1,190.40	£1,335.00	£1,602.00

\*\*Valves Prices include a choice of either chrome or white, angled KINGSTON TRVs, (Straight valves available on request).

## Pipe Centres & Technical Drawings

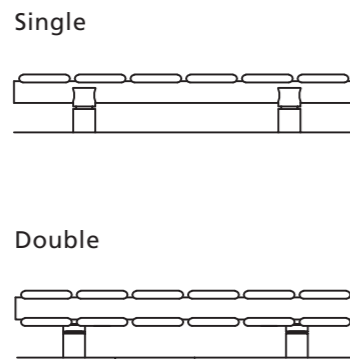
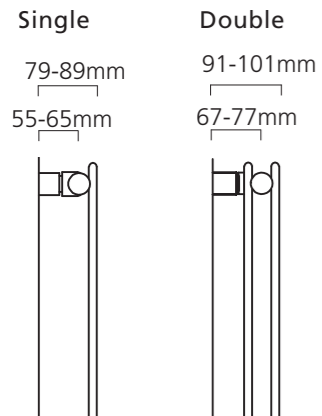

**Single Vertical**  
 Pipe centres left to right = Width plus valves  
 Pipe centres from wall = 55mm - 65mm  
 Depth from wall = 79mm - 89mm

**Double Vertical**  
 Pipe centres left to right = Width plus valves  
 Pipe centres from wall = 67mm - 77mm  
 Depth from wall = 91mm - 101mm

23 RAL Colours & 10 special finishes available (see pages 12-13 for full RAL and Special Finish options).



Please note: Due to printing processes & manufacturing tolerances the colour of finished radiators may vary from the colours represented in this brochure.

+Valves Prices include angled chrome or white KINGSTON TRVs

Please specify at time of order



Horizontal (pg.54-55)



BEAUFORT Slim (pg.58-59)



♦ BEAUFORT Single Vertical (BOE Connections) 1820mm x 540mm in Grey Aluminium with Chrome KINGSTON TRVs.



# BEAUFORT Slim

- Italian design & manufacture, steel vertical radiator
- 70mm flat tube steel radiator with underneath connections only
- Standard white RAL 9016 delivered in 48-72 hours
- 23 RAL colours, 10 special finishes, up to 10 working days (pg.12-13)



## Sizes & Prices (Underneath Connections)

Please add 10% to the RAL colour price to work out your special finish price.

Dimensions (mm)		Elements	Output Δt 50°C		Product Code	White Ex VAT	White Inc VAT	RAL Colour Ex VAT	RAL Colour Inc VAT	White +Valves Ex VAT	White +Valves Inc VAT	RAL Colour +Valves Ex VAT	RAL Colour +Valves Inc VAT
Height	Width		Watts	Btu's									
<b>Vertical - Single</b>													
1820	160	2	294	1003	BEAUF181602SUC	£254.00	£304.80	£397.00	£476.40	£322.00	£386.40	£465.00	£558.00
	236	3	441	1505	BEAUF182303SUC	£293.00	£351.60	£443.00	£531.60	£361.00	£433.20	£511.00	£613.20
	312	4	588	2006	BEAUF183104SUC	£337.00	£404.40	£509.00	£610.80	£405.00	£486.00	£577.00	£692.40
	388	5	735	2508	BEAUF183805SUC	£376.00	£451.20	£603.00	£723.60	£444.00	£532.80	£671.00	£805.20
	464	6	881	3006	BEAUF184606SUC	£440.00	£528.00	£700.00	£840.00	£508.00	£609.60	£768.00	£921.60
2020	160	2	328	1119	BEAUF201602SUC	£422.00	£506.40	£579.00	£694.80	£490.00	£588.00	£647.00	£776.40
	236	3	492	1679	BEAUF202303SUC	£468.00	£561.60	£628.00	£753.60	£536.00	£643.20	£696.00	£835.20
	312	4	656	2238	BEAUF203104SUC	£513.00	£615.60	£712.00	£854.40	£581.00	£697.20	£780.00	£936.00
	388	5	820	2798	BEAUF203805SUC	£568.00	£681.60	£810.00	£972.00	£636.00	£763.20	£878.00	£1,053.60
	464	6	984	3357	BEAUF204606SUC	£625.00	£750.00	£909.00	£1,090.80	£693.00	£831.60	£977.00	£1,172.40
<b>Vertical - Double</b>													
1820	160	4	420	1433	BEAUF181604DUC	£438.00	£525.60	£600.00	£720.00	£506.00	£607.20	£668.00	£801.60
	236	6	630	2150	BEAUF182306DUC	£519.00	£622.80	£688.00	£825.60	£587.00	£704.40	£756.00	£907.20
	312	8	840	2866	BEAUF183108DUC	£589.00	£706.80	£788.00	£945.60	£657.00	£788.40	£856.00	£1,027.20
	388	10	1050	3583	BEAUF183810DUC	£675.00	£810.00	£927.00	£1,112.40	£743.00	£891.60	£995.00	£1,194.00
	464	12	1259	4296	BEAUF184612DUC	£769.00	£922.80	£1,071.00	£1,285.20	£837.00	£1,004.40	£1,139.00	£1,366.80
2020	160	4	466	1590	BEAUF201604DUC	£613.00	£735.60	£788.00	£945.60	£681.00	£817.20	£856.00	£1,027.20
	236	6	699	2385	BEAUF202306DUC	£686.00	£823.20	£869.00	£1,042.80	£754.00	£904.80	£937.00	£1,124.40
	312	8	932	3180	BEAUF203108DUC	£762.00	£914.40	£983.00	£1,179.60	£830.00	£996.00	£1,051.00	£1,261.20
	388	10	1166	3978	BEAUF203810DUC	£840.00	£1,008.00	£1,105.00	£1,326.00	£908.00	£1,089.60	£1,173.00	£1,407.60
	464	12	1399	4773	BEAUF204612DUC	£946.00	£1,135.20	£1,259.00	£1,510.80	£1,014.00	£1,216.80	£1,327.00	£1,592.40

\*+Valves Prices include a choice of either chrome or white, straight KINGSTON TRVs, (if you require angled valves please specify).

## Pipe Centres & Technical Drawings

**Single**

79-89mm  
55-65mm

**Double**

91-101mm  
67-77mm

**Single**

**Double**

**Single**  
 Pipe centres left to right = Width less 84mm  
 Pipe centres from wall = 55mm - 65mm  
 Depth from wall = 79mm - 89mm

**Double**  
 Pipe centres left to right = Width less 84mm  
 Pipe centres from wall = 67mm - 77mm  
 Depth from wall = 91mm - 101mm

+Valves Prices include straight chrome or white KINGSTON TRVs

Please specify at time of order

Double Horizontal (pg.54-55)

Underneath Connections



◆BEAUFORT Slim Single 1820mm x 388mm in Matt Black shown with nickel KINGSTON TRVs.







# TALLIS Horizontal

- Italian design & manufacture, steel horizontal radiator
- 50mm x 25mm oval tubes in single & double; 3 heights & 3 widths
- Standard white RAL 9016 delivered in 48-72 hours
- 23 RAL colours, 10 special finishes, up to 10 working days (pg.12-13)



## Sizes and Prices

Please add 10% to the RAL colour price to work out your special finish price.

Dimensions (mm)		Elements	Output Δt 50°C		Product Code	White Ex VAT	White Inc VAT	RAL Colour Ex VAT	RAL Colour Inc VAT	White +Valves Ex VAT	White +Valves Inc VAT	RAL Colour +Valves Ex VAT	RAL Colour +Valves Inc VAT
Height	Width		Watts	Btu's									
<b>Horizontal - Single</b>													
420	1020	7	481	1641	TALL421007SH	£290.00	£348.00	£441.00	£529.20	£358.00	£429.60	£509.00	£610.80
	1220	7	575	1962	TALL421207SH	£299.00	£358.80	£453.00	£543.60	£367.00	£440.40	£521.00	£625.20
	1520	7	717	2446	TALL421507SH	£334.00	£400.80	£496.00	£595.20	£402.00	£482.40	£564.00	£676.80
480	1020	8	549	1873	TALL481008SH	£321.00	£385.20	£491.00	£589.20	£389.00	£466.80	£559.00	£670.80
	1220	8	657	2242	TALL481208SH	£324.00	£388.80	£519.00	£622.80	£392.00	£470.40	£587.00	£704.40
	1520	8	818	2791	TALL481508SH	£383.00	£459.60	£564.00	£676.80	£451.00	£541.20	£632.00	£758.40
600	1020	10	686	2341	TALL601010SH ♦	£373.00	£447.60	£588.00	£705.60	£441.00	£529.20	£656.00	£787.20
	1220	10	821	2801	TALL601210SH	£401.00	£481.20	£647.00	£776.40	£469.00	£562.80	£715.00	£858.00
	1520	10	1022	3487	TALL601510SH	£479.00	£574.80	£706.00	£847.20	£547.00	£656.40	£774.00	£928.80
<b>Horizontal - Double</b>													
420	1020	14	748	2552	TALL421014DH	£443.00	£531.60	£614.00	£736.80	£511.00	£613.20	£682.00	£818.40
	1220	14	895	3054	TALL421214DH	£482.00	£578.40	£657.00	£788.40	£550.00	£660.00	£725.00	£870.00
	1520	14	1115	3804	TALL421514DH	£553.00	£663.60	£716.00	£859.20	£621.00	£745.20	£784.00	£940.80
480	1020	16	855	2917	TALL481016DH	£508.00	£609.60	£686.00	£823.20	£576.00	£691.20	£754.00	£904.80
	1220	16	1023	3490	TALL481216DH	£518.00	£621.60	£753.00	£903.60	£586.00	£703.20	£821.00	£985.20
	1520	16	1274	4347	TALL481516DH	£630.00	£756.00	£817.00	£980.40	£698.00	£837.60	£885.00	£1,062.00
600	1020	20	1069	3647	TALL601020DH	£591.00	£709.20	£842.00	£1,010.40	£659.00	£790.80	£910.00	£1,092.00
	1220	20	1279	4364	TALL601220DH	£625.00	£750.00	£914.00	£1,096.80	£693.00	£831.60	£982.00	£1,178.40
	1520	20	1593	5435	TALL601520DH	£752.00	£902.40	£985.00	£1,182.00	£820.00	£984.00	£1,053.00	£1,263.60

\*+Valves Prices include a choice of either chrome or white, straight KINGSTON TRVs, (if you require angled valves please specify).

## Pipe Centres and Technical Drawings

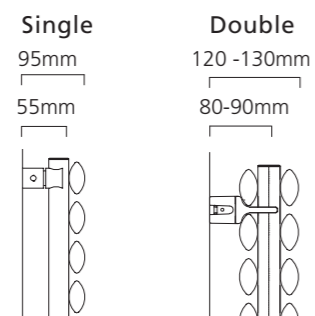
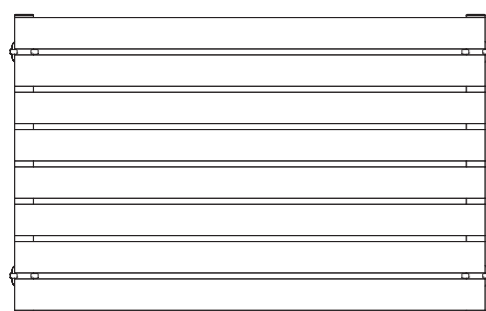

**Single Horizontal**  
Pipe centres left to right = Width less 50mm  
Pipe centres from wall = 55mm  
Depth from wall = 95mm

**Double Horizontal**  
Pipe centres left to right = Width less 50mm  
Pipe centres from wall = 80mm - 90mm  
Depth from wall = 120mm - 130mm

23 RAL Colours & 10 special finishes available (see pages 12-13 for full RAL and Special Finish options).



Please note: Due to printing processes & manufacturing tolerances the colour of finished radiators may vary from the colours represented in this brochure.



+Valves Prices include straight chrome or white KINGSTON TRVs

Please specify at time of order

♦TALLIS Double Horizontal in White RAL 9016, 600mm x 1020mm shown with white KINGSTON TRVs.



# TALLIS Vertical

- Italian design & manufacture, steel vertical radiator
- 50mm x 25mm oval tubes in single & double; 1 heights & 4 widths
- Standard white RAL 9016 delivered in 48-72 hours
- 23 RAL colours, 10 special finishes, up to 10 working days (pg.12-13)

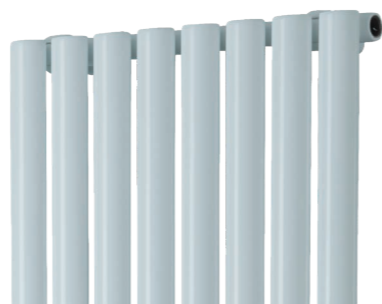

## Sizes and Prices

Please add 10% to the RAL colour price to work out your special finish price.

Dimensions (mm)		Elements	Output Δt 50°C		Product Code	White Ex VAT	White Inc VAT	RAL Colour Ex VAT	RAL Colour Inc VAT	White +Valves Ex VAT	White +Valves Inc VAT	RAL Colour +Valves Ex VAT	RAL Colour +Valves Inc VAT
Height	Width		Watts	Btu's									
<b>Vertical - Single</b>													
1820	300	5	627	2139	TALL183005SV	£299.00	£358.80	£429.00	£514.80	£367.00	£440.40	£497.00	£596.40
	420	7	878	2996	TALL184207SV	£318.00	£381.60	£532.00	£638.40	£386.00	£463.20	£600.00	£720.00
	480	8	1004	3426	TALL184808SV	£360.00	£432.00	£611.00	£733.20	£428.00	£513.60	£679.00	£814.80
	600	10	1255	4282	TALL186010SV	£446.00	£535.20	£767.00	£920.40	£514.00	£616.80	£835.00	£1,002.00
<b>Vertical - Double</b>													
1820	300	10	950	3241	TALL183010DV	£425.00	£510.00	£615.00	£738.00	£493.00	£591.60	£683.00	£819.60
	420	14	1331	4541	TALL184214DV	£530.00	£636.00	£774.00	£928.80	£598.00	£717.60	£842.00	£1,010.40
	480	16	1521	5190	TALL184816DV	£595.00	£714.00	£884.00	£1,060.80	£663.00	£795.60	£952.00	£1,142.40
	600	20	1901	6486	TALL186020DV	£704.00	£844.80	£1,058.00	£1,269.60	£772.00	£926.40	£1,126.00	£1,351.20

\*+Valves Prices include a choice of either chrome or white, angled KINGSTON TRVs, (if you require straight valves please specify).

## Pipe Centres and Technical Drawings

### Single

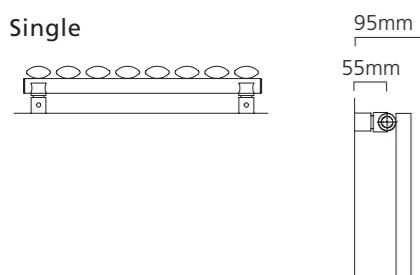

**Single Vertical**  
 Pipe centres left to right = Width plus valves  
 Pipe centres from wall = 55mm  
 Depth from wall = 95mm

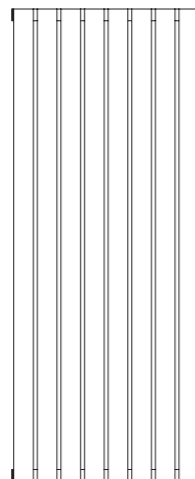

### Double

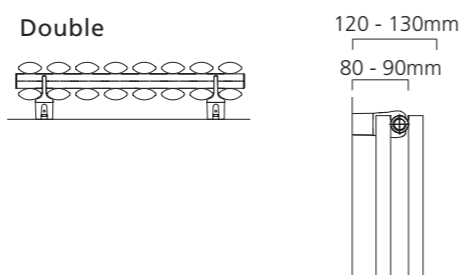

**Double Vertical**  
 Pipe centres left to right = Width plus valves  
 Pipe centres from wall = 80mm - 90mm  
 Depth from wall = 120mm - 130mm

23 RAL Colours & 10 special finishes available (see pages 12-13 for full RAL and Special Finish options).

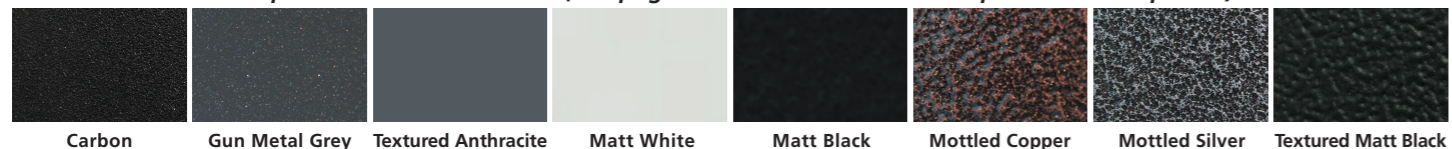

Please note: Due to printing processes & manufacturing tolerances the colour of finished radiators may vary from the colours represented in this brochure.

+Valves Prices include Angled Chrome or White KINGSTON TRVs

Please specify at time of order



TALLIS FUSION (pg.73)



◆TALLIS Single Vertical in White RAL 9016 1820mm x 480mm shown with WELLINGTON TRVs.



# CHAUCER Horizontal

- Italian design & manufacture, steel horizontal radiator
- 23mm round tubes in 2 heights & 3 widths in single & double
- Standard white RAL 9016 delivered in 48-72 hours
- 23 RAL colours, 10 special finishes, up to 10 working days (pg.12-13)



## Sizes and Prices

Please add 10% to the RAL colour price to work out your special finish price.

Dimensions (mm)		Elements	Output Δt 50°C		Product Code	White Ex VAT	White Inc VAT	RAL Colour Ex VAT	RAL Colour Inc VAT	White +Valves Ex VAT	White +Valves Inc VAT	RAL Colour +Valves Ex VAT	RAL Colour +Valves Inc VAT
Height	Width		Watts	Btu's									
<b>Horizontal - Single</b>													
402	920	12	515	1757	CHAU409212SH	£256.00	£307.20	£381.00	£457.20	£324.00	£388.80	£449.00	£538.80
	1220	12	683	2330	CHAU401212SH	£273.00	£327.60	£428.00	£513.60	£341.00	£409.20	£496.00	£595.20
	1520	12	851	2904	CHAU401512SH	£321.00	£385.20	£478.00	£573.60	£389.00	£466.80	£546.00	£655.20
538	920	16	681	2324	CHAU539216SH	£291.00	£349.20	£452.00	£542.40	£359.00	£430.80	£520.00	£624.00
	1220	16	903	3081	CHAU531216SH	£340.00	£408.00	£531.00	£637.20	£408.00	£489.60	£599.00	£718.80
	1520	16	1124	3835	CHAU531516SH	£373.00	£447.60	£590.00	£708.00	£441.00	£529.20	£658.00	£789.60
<b>Horizontal - Double</b>													
402	920	24	782	2668	CHAU409224DH	£387.00	£464.40	£555.00	£666.00	£455.00	£546.00	£623.00	£747.60
	1220	24	1037	3538	CHAU401224DH	£457.00	£548.40	£634.00	£760.80	£525.00	£630.00	£702.00	£842.40
	1520	24	1292	4408	CHAU401524DH	£553.00	£663.60	£706.00	£847.20	£621.00	£745.20	£774.00	£928.80
538	920	32	955	3258	CHAU539232DH	£501.00	£601.20	£662.00	£794.40	£569.00	£682.80	£730.00	£876.00
	1220	32	1266	4320	CHAU531232DH	£567.00	£680.40	£789.00	£946.80	£635.00	£762.00	£857.00	£1,028.40
	1520	32	1577	5381	CHAU531532DH	£595.00	£714.00	£826.00	£991.20	£663.00	£795.60	£894.00	£1,072.80

\*+Valves Prices include a choice of either chrome or white, straight KINGSTON TRVs, (if you require angled valves please specify).

Actual tube size 23mm

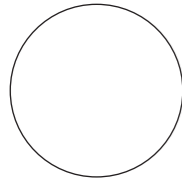

## Pipe Centres and Technical Drawings

Single

90mm  
55mm

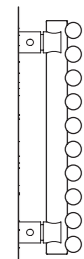

Double

114-124mm  
79-89mm

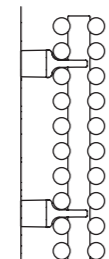

Pipe centres left to right = Width less 50mm  
 Pipe centres from wall = single - 55mm  
 = double - 79mm-89mm  
 Depth from wall = single - 90mm  
 = double - 114mm-124mm



◆CHAUCER Single Horizontal 402mm x 1220mm shown in RAL 9004 Signal Black with chrome KINGSTON TRVs.

Matching 23mm round tubed CHAUCER Side Rail (pg.74-75).



# CHAUCER Vertical

- Italian design & manufacture, steel vertical radiator
- 23mm round tubes available in 1 height & 4 widths in single & double
- Standard white RAL 9016 delivered in 48-72 hours
- 23 RAL colours, 10 special finishes, up to 10 working days (pg.12-13)

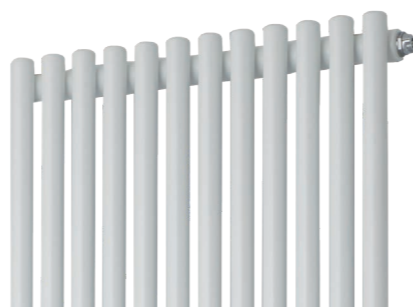

## Sizes and Prices

Please add 10% to the RAL colour price to work out your special finish price.

Dimensions (mm)		Elements	Output Δt 50°C		Product Code	White Ex VAT	White Inc VAT	RAL Colour Ex VAT	RAL Colour Inc VAT	White +Valves Ex VAT	White +Valves Inc VAT	RAL Colour +Valves Ex VAT	RAL Colour +Valves Inc VAT
Height	Width		Watts	Btu's									
<b>Vertical - Single</b>													
1820	300	9	706	2409	CHAU183009SV	£325.00	£390.00	£487.00	£584.40	£393.00	£471.60	£555.00	£666.00
	402	12	941	3211	CHAU184012SV	£369.00	£442.80	£553.00	£663.60	£437.00	£524.40	£621.00	£745.20
	504	15	1176	4013	CHAU185015SV	£413.00	£495.60	£683.00	£819.60	£481.00	£577.20	£751.00	£901.20
	606	18	1411	4814	CHAU186018SV	£455.00	£546.00	£751.00	£901.20	£523.00	£627.60	£819.00	£982.80
<b>Vertical - Double</b>													
1820	300	18	1056	3603	CHAU183018DV	£521.00	£625.20	£696.00	£835.20	£589.00	£706.80	£764.00	£916.80
	402	24	1408	4804	CHAU184024DV ♦	£595.00	£714.00	£805.00	£966.00	£663.00	£795.60	£873.00	£1,047.60
	504	30	1760	6005	CHAU185030DV	£682.00	£818.40	£1,009.00	£1,210.80	£750.00	£900.00	£1,077.00	£1,292.40
	606	36	2111	7203	CHAU186036DV	£765.00	£918.00	£1,143.00	£1,371.60	£833.00	£999.60	£1,211.00	£1,453.20

\*+Valves Prices include a choice of either chrome or white, angled KINGSTON TRVs, (if you require straight valves please specify).

Actual tube size 23mm

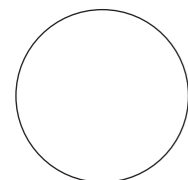

## Pipe Centres and Technical Drawings

Single

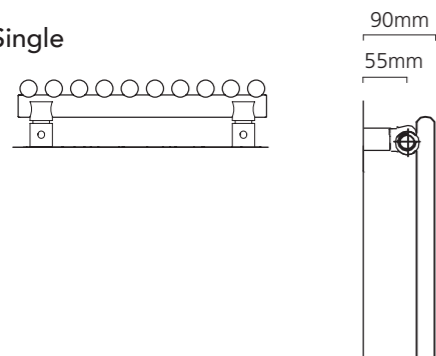

### Single Vertical

Pipe centres left to right = Width plus valves  
 Pipe centres from wall = 55mm  
 Depth from wall = 90mm

Double

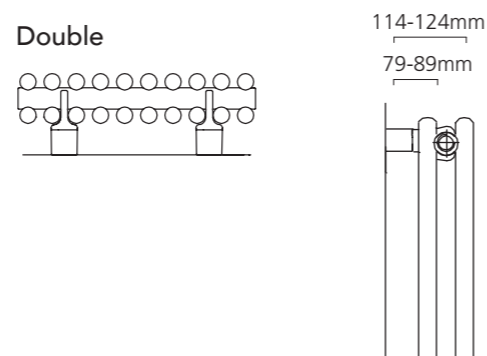

### Double Vertical

Pipe centres left to right = Width plus valves  
 Pipe centres from wall = 79mm - 89mm  
 Depth from wall = 114mm - 124mm



Horizontal (pg.66-67)

+Valves Prices include angled chrome or white KINGSTON TRVs



Please specify at time of order



Single Vertical

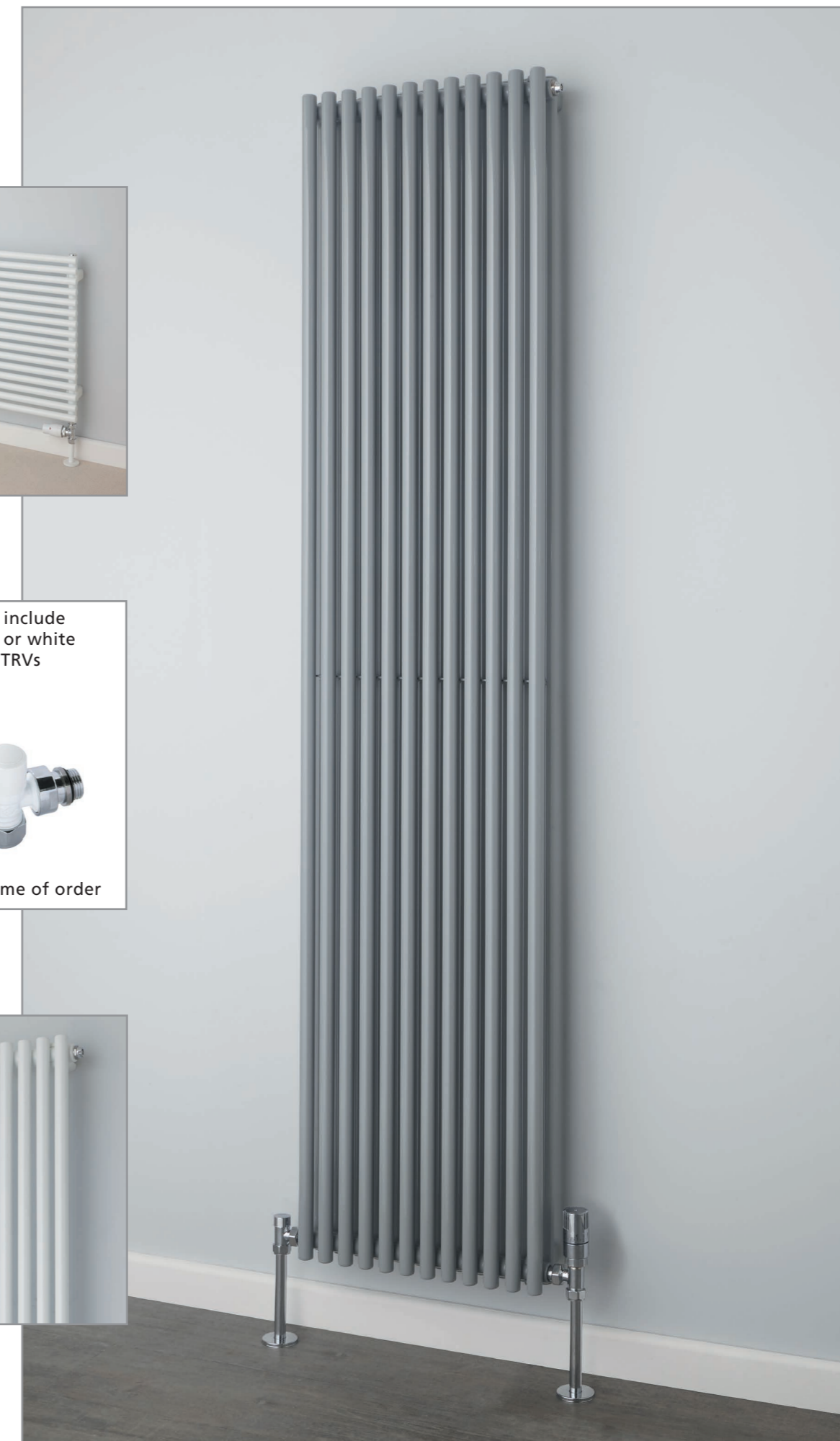

♦ CHAUCER Double Vertical in RAL 7042 Traffic Grey A, 1820mm x 402mm shown with KINGSTON TRVs.



# HORNBY

- 40mm round tubes available in hydronic and electric options
- Steel radiator available in 2 heights & 7 widths in horizontal & vertical
- Standard white RAL 9016 delivered in 48-72 hours
- 23 RAL colours, 10 special finishes, up to 10 working days (pg.12-13)



## Hydronic Sizes and Prices

Please add 10% to the RAL colour price to work out your special finish price.

Dimensions (mm)		Elements	Output Δt 50°C		Product Code	White Ex VAT	White Inc VAT	RAL Colour Ex VAT	RAL Colour Inc VAT	White +Valves Ex VAT	White +Valves Inc VAT	RAL Colour +Valves Ex VAT	RAL Colour +Valves Inc VAT
Height	Width		Watts	Btu's									
<b>Horizontal</b>													
500	865	16	591	2016	HORN508616H	£483.00	£579.60	£571.00	£685.20	£551.00	£661.20	£639.00	£766.80
	1195	22	812	2771	HORN501122H	£611.00	£733.20	£691.00	£829.20	£679.00	£814.80	£759.00	£910.80
	1470	27	997	3402	HORN501427H	£721.00	£865.20	£803.00	£963.60	£789.00	£946.80	£871.00	£1,045.20
<b>Vertical</b>													
1800	260	5	573	1955	HORN182605V	£417.00	£500.40	£503.00	£603.60	£485.00	£582.00	£571.00	£685.20
	370	7	802	2736	HORN183707V	£499.00	£598.80	£602.00	£722.40	£567.00	£680.40	£670.00	£804.00
	480	9	1031	3518	HORN184809V	£617.00	£740.40	£708.00	£849.60	£685.00	£822.00	£776.00	£931.20
	590	11	1260	4299	HORN185911V	£702.00	£842.40	£1,005.00	£1,206.00	£770.00	£924.00	£1,073.00	£1,287.60

\*+Valves Prices include a choice of either chrome or white, angled KINGSTON TRVs, (if you require straight valves please specify).

## Electric Sizes and Prices - White Vertical only

Supplied as standard with MOA Bluetooth Element

Dimensions (mm)		Elements	Output Δt 50°C Watts	Product Code	White Ex VAT	White Inc VAT
Height	Width					
1800	370	7	800	HORN183707EW	£799.00	£958.80
	480	9	1000	HORN184809EW	£915.00	£1,098.00

## MOA Bluetooth Element (2 year guarantee)

- 5 heat settings from 30° to 60°, denoted by 5 LED's
- Full operational control of the element on smartphone / tablet via Bluetooth (with "Terma BLUE-Line" App: iOS / Android)
- 7 day timer. 2 hour drying function
- IPx5. Class 1
- Connect to an appropriate fused spur
- Lot20 EcoDesign Directive Compliant\*



\*Lot 20 EcoDesign Directive Compliancy - MOA Blue is compliant with Lot 20; whereby an electric room radiator (does not apply to electric towel rails) has to have a weekly timer and adaptive start controll/out of home control. For more information: [www.lot20.co.uk](http://www.lot20.co.uk)

## Pipe Centres and Technical Drawings

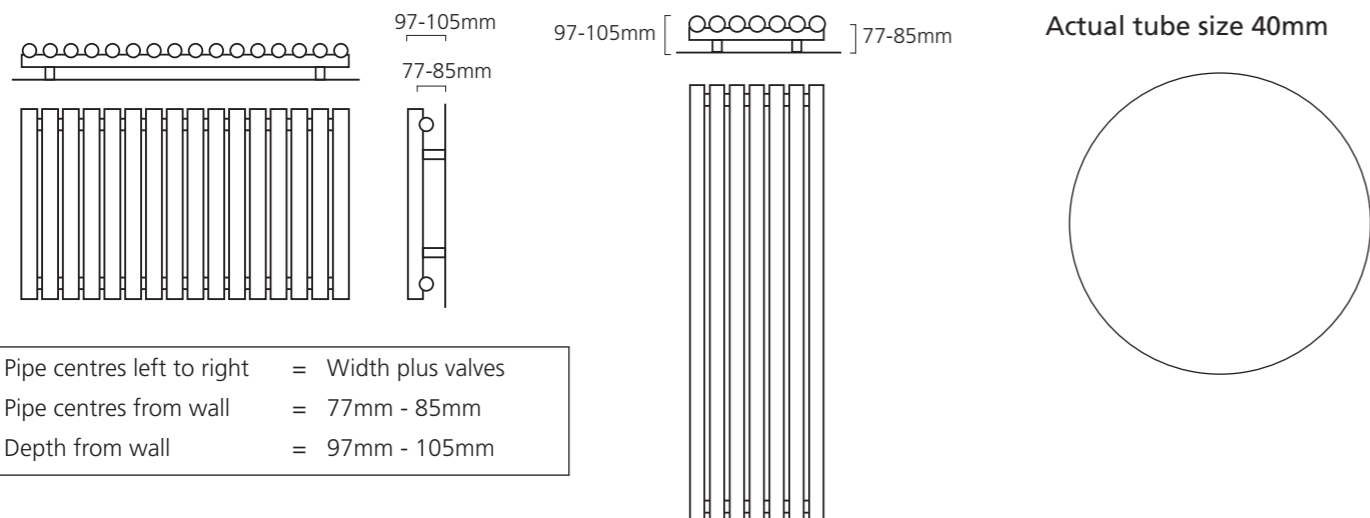

Pipe centres left to right = Width plus valves  
 Pipe centres from wall = 77mm - 85mm  
 Depth from wall = 97mm - 105mm



Horizontal in Gun Metal Grey

+Valves Prices for hydronic models include angled chrome or white KINGSTON TRVs

Please specify at time of order



Electric version



◆ HORNBY Vertical in White RAL 9016, 1800mm x 480mm shown with white KINGSTON TRVs.



# TALLIS

## Ladder Rail



- Italian design & manufacture
- +Valves prices include chrome DRAKE valves\*
- 50mm x 25mm oval tube steel towel rail
- White RAL 9016 as standard delivered in 48-72 hours
- Optional next-day delivery available (pg.2)
- 23 RAL colours, 10 special finishes, up to 8 working days (pg.12-13)
- Dual fuel available, please specify at time of order

### Pipe Centres and Technical Drawings

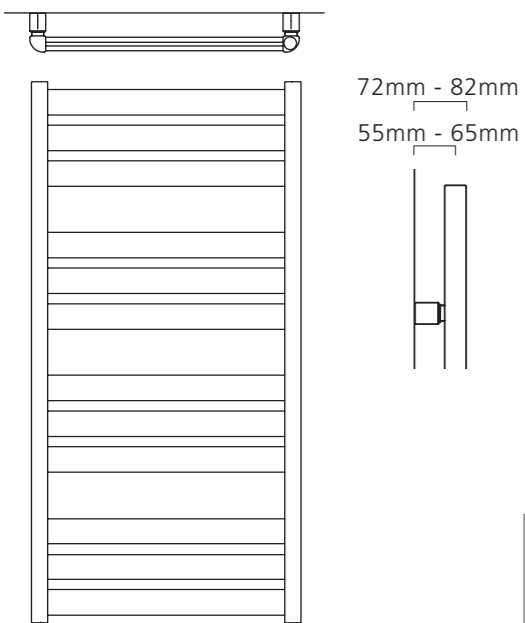

Pipe centres left to right = width less 30mm  
 Pipe centres from wall = 55mm - 65mm  
 Depth from wall = 72mm - 82mm



◆ 1340mm x 600mm shown in Gun Metal Grey with DRAKE valves.

### TALLIS Ladder Rail Sizes and Prices

Please add 10% to the RAL colour price to work out your special finish price.

Dimensions (mm)	Cross Tubes	Output Δt 50°C		Product Code	White Ex VAT	White Inc VAT	RAL Colour Ex VAT	RAL Colour Inc VAT	White +Valves Ex VAT	White +Valves Inc VAT	RAL Colour +Valves Ex VAT	RAL Colour +Valves Inc VAT	
		Watts	Btu's										
780	500	9	345	1177	TALLLR785009	£219.00	£262.80	£362.00	£434.40	£248.00	£297.60	£391.00	£469.20
	600	9	404	1378	TALLLR786009	£274.00	£328.80	£393.00	£471.60	£303.00	£363.60	£422.00	£506.40
1060	500	12	463	1580	TALLLR105012	£314.00	£376.80	£449.00	£538.80	£343.00	£411.60	£478.00	£573.60
	600	12	546	1863	TALLLR106012	£341.00	£409.20	£488.00	£585.60	£370.00	£444.00	£517.00	£620.40
1340	500	15	581	1982	TALLLR135015	£371.00	£445.20	£522.00	£626.40	£400.00	£480.00	£551.00	£661.20
	600	15	680	2320	TALLLR136015	£409.00	£490.80	£593.00	£711.60	£438.00	£525.60	£622.00	£746.40

\*\*Valves Prices include angled chrome DRAKE Valves, please specify at time of order if you require straight valves.  
 The TALLIS Ladder Rail is suitable for use as dual fuel, please see pages 98-99 for available Electric Elements.

# TALLIS

## FUSION



- +Valves prices include Chrome DRAKE Valves\*
- Contemporary steel ladder rail with Tallis vertical oval tubed steel radiator inside for additional output
- Chrome and White RAL 9016 only
- Delivered in 48-72 hours
- Optional next-day delivery available (pg.2)
- Dual fuel available, please specify at time of order

### Pipe Centres and Technical Drawings

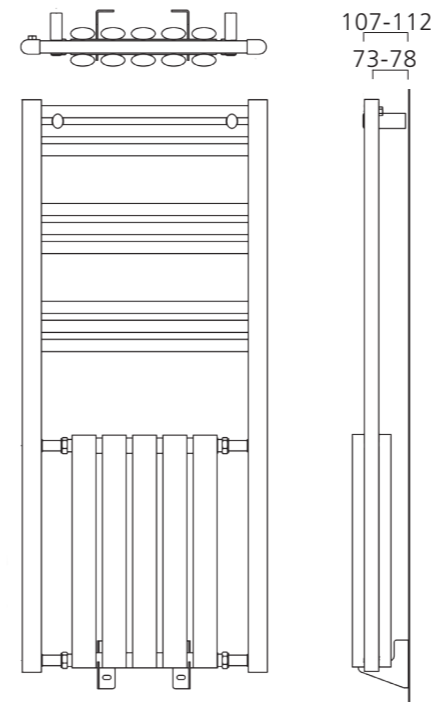

Pipe centres left to right = width less 36mm  
 Pipe centres from wall = 73mm - 78mm  
 Depth from wall = 107mm - 112mm



◆ 1200mm x 500mm shown with chrome DRAKE Valves.

### TALLIS FUSION Sizes and Prices

Dimensions (mm)		Elements	Output Δt 50°C		Product Code	Price Ex VAT	Price Inc VAT	Price +Valves Ex VAT	Price +Valves Inc VAT
Height	Width		Watts	Btu's					
1200	500	10	499	1703	TALF125010	£690.00	£828.00	£719.00	£862.80

\*\*Valves Prices include angled chrome DRAKE Valves, please specify at time of order if you require straight valves.  
 The TALLIS FUSION is suitable for use as dual fuel, please see pages 98-99 for available Electric Elements.



# CHAUCER Side Rail

- Italian design & manufacture, steel towel rail
- Side loading towel rail with 23mm round tubes
- White RAL 9016 delivered as standard in 48-72 hours
- Optional next-day delivery available (pg.2)
- 23 RAL colours, 10 special finishes, up to 8 working days (pg.12-13)
- Dual fuel available, please specify at time of order

STOCK

NEXT DAY OPTION

10 YEAR GUARANTEE

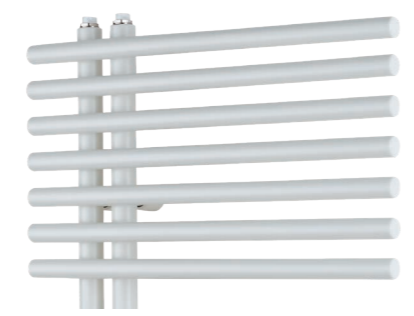

## Sizes and Prices

Please add 10% to the RAL colour price to work out your special finish price.

Dimensions (mm)		Output Δt 50°C		Product Code	White Ex VAT	White Inc VAT	RAL Colour Ex VAT	RAL Colour Inc VAT	White +Valves Ex VAT	White +Valves Inc VAT	RAL Colour +Valves Ex VAT	RAL Colour +Valves Inc VAT
Height	Width	Watts	Btu's									
832	500	394	1344	CHAUSR8350	£249.00	£298.80	£360.00	£432.00	£278.00	£333.60	£389.00	£466.80
	600	455	1552	CHAUSR8360	£258.00	£309.60	£369.00	£442.80	£287.00	£344.40	£398.00	£477.60
1348	500	612	2088	CHAUSR1350	£306.00	£367.20	£448.00	£537.60	£335.00	£402.00	£477.00	£572.40
	600	708	2416	CHAUSR1360	£317.00	£380.40	£486.00	£583.20	£346.00	£415.20	£515.00	£618.00

\*+Valves Prices include angled chrome DRAKE Valves, please specify at time of order if you require straight valves. The CHAUCER Side Rail is suitable for use as dual fuel, please see pages 98-99 for available Electric Elements.

## Pipe Centres and Technical Drawings

The Chaucer Side Rail can be hung left or right-handed.

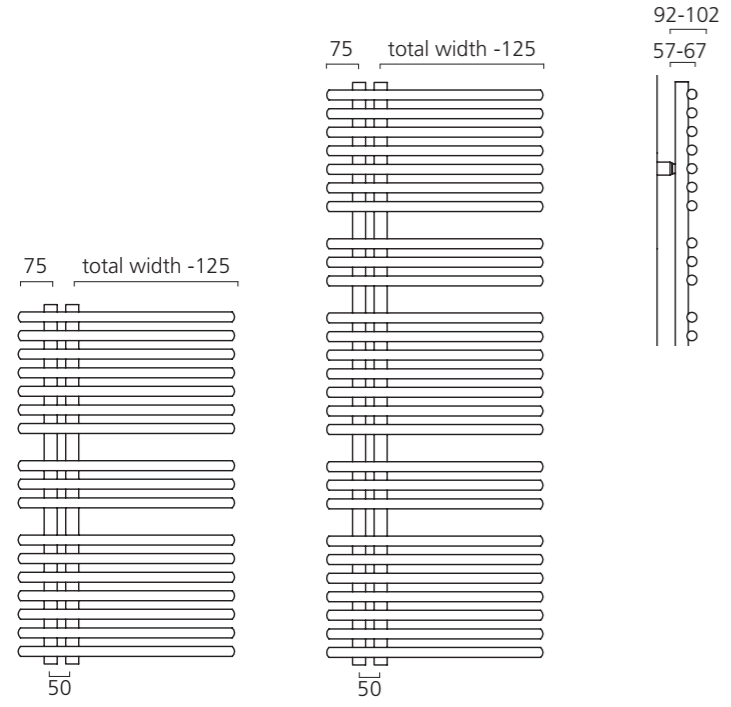

Pipe centres left to right = 50mm  
 Pipe centres from wall = 57mm - 67mm  
 Depth from wall = 92mm - 102mm

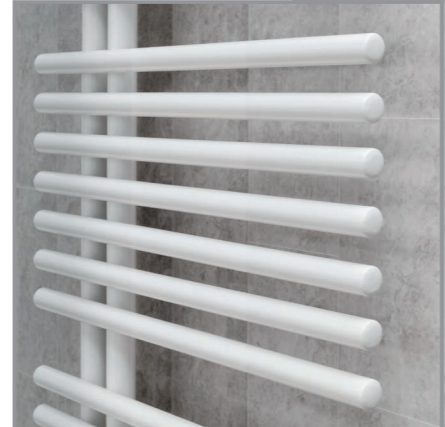

Side Rail detail



+Valves Prices include angled chrome DRAKE Valves

Please specify at time of order



50mm connections

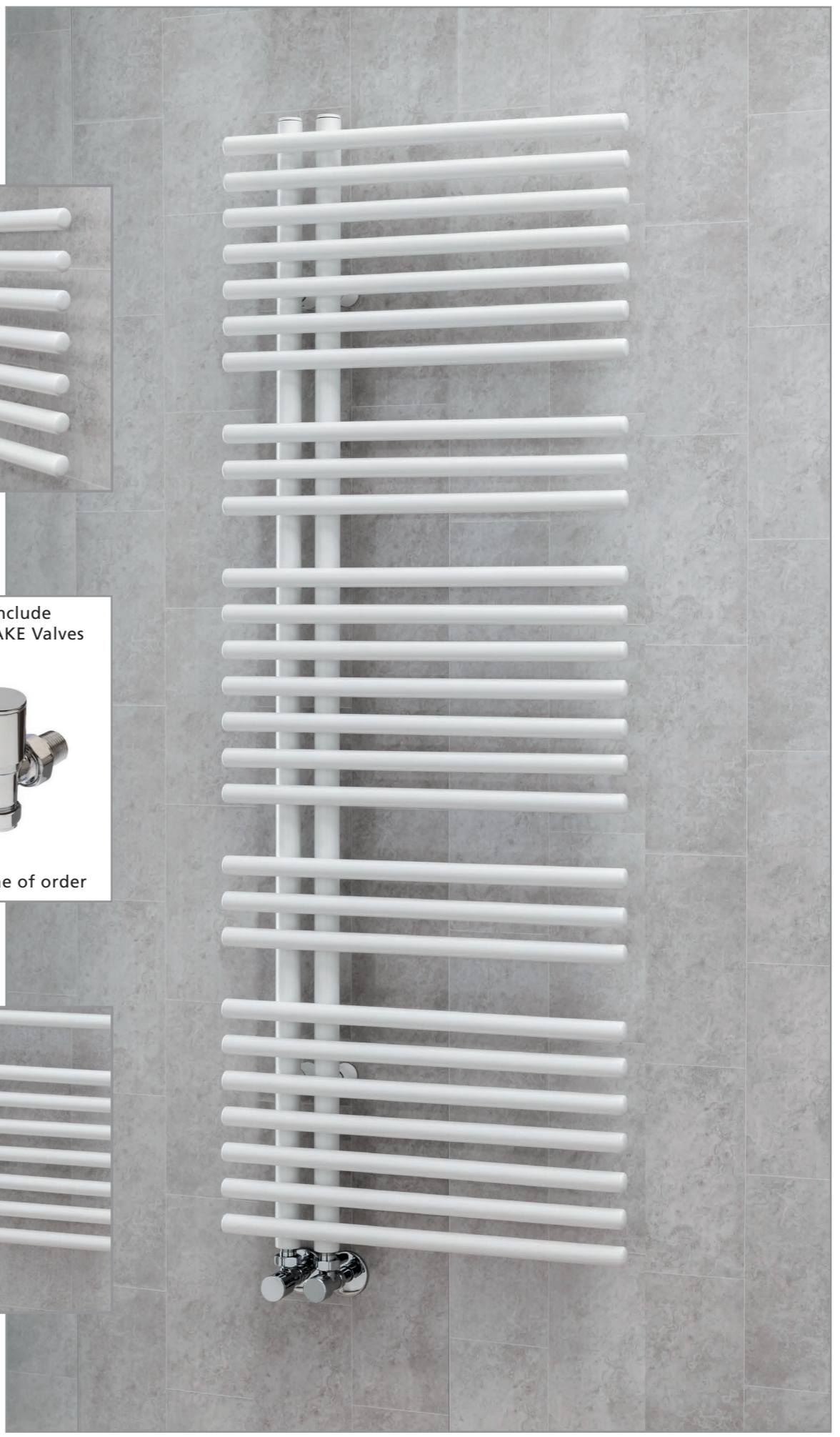

◆ CHAUCER Side Rail 1348mm x 500mm in White RAL 9016 shown with DRAKE Valves.

23 RAL Colours & 10 special finishes available (see pages 12-13 for full RAL and Special Finish options)



Please note: Due to printing processes & manufacturing tolerances the colour of finished radiators may vary from the colours represented in this brochure.



# APSLEY Towel Rail

- 22mm cross tubes with extended towel bars
- Steel towel rail available in hydronic and electric versions
- White RAL 9016 as standard delivered in 48-72 hours
- Optional next-day delivery available (pg.2)
- 23 RAL colours and 10 special finishes delivered in up to 8 working days for hydronic models only (pg. 12-13)
- Dual fuel available, please specify at time of order

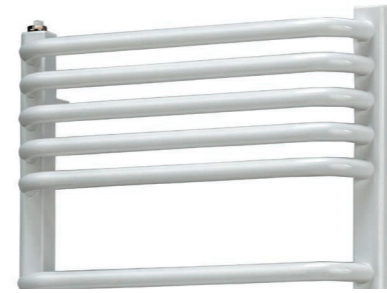

## Hydronic Sizes and Prices

Please add 10% to the RAL colour price to work out your special finish price.

Dimensions (mm)		Cross Tubes	Output Δt 50°C		Product Code	White Ex VAT	White Inc VAT	RAL Colour Ex VAT	RAL Colour Inc VAT	White +Valves Ex VAT	White +Valves Inc VAT	RAL Colour +Valves Ex VAT	RAL Colour +Valves Inc VAT
Height	Width		Watts	Btu's									
620	500	11	300	1024	APSL625011	£127.00	£152.40	£218.00	£261.60	£156.00	£187.20	£247.00	£296.40
	600	11	344	1174	APSL626011	£144.00	£172.80	£249.00	£298.80	£173.00	£207.60	£278.00	£333.60
900	500	16	440	1501	APSL905016	£148.00	£177.60	£251.00	£301.20	£177.00	£212.40	£280.00	£336.00
	600	16	506	1726	APSL906016	£184.00	£220.80	£291.00	£349.20	£213.00	£255.60	£320.00	£384.00
1100	500	19	540	1842	APSL115019	£161.00	£193.20	£293.00	£351.60	£190.00	£228.00	£322.00	£386.40
	600	19	622	2122	APSL116019	£206.00	£247.20	£337.00	£404.40	£235.00	£282.00	£366.00	£439.20
1300	500	24	641	2187	APSL135024	£188.00	£225.60	£329.00	£394.80	£217.00	£260.40	£358.00	£429.60
	600	24	737	2515	APSL136024	£233.00	£279.60	£375.00	£450.00	£262.00	£314.40	£404.00	£484.80

\*+Valves Prices include angled chrome DRAKE Valves, please specify at time of order if you require straight valves.  
The APSLEY Towel Rail is suitable for use as dual fuel, please see pages 98-99 for available Electric Elements.

## Electric Sizes and Prices in White Only

Supplied with an internalised heating element

Dimensions (mm)		Cross Tubes	Output Δt 50°C Watts	Product Code	White Ex VAT	White Inc VAT
Height	Width					
760	500	14	400	APSL7650EW	£344.00	£412.80
1140	500	22	600	APSL1150EW	£425.00	£510.00
1580	500	30	800	APSL1550EW	£498.00	£597.60

## Internal Heating Element (2-year guarantee)

- Electric towel rail supplied with a minimalist heating element
- Discreet underside control button & miniature front-facing LED panel fitted to the right-hand side. Note: This cannot be moved to the left-hand side
- 2 heat settings 45°C and 60°C regulating the internal radiator temperature, denoted by multi-colour LED
- Cable runs out through the bottom right mounting bracket
- Features a 2hr drying function. Compatible with external timer
- IPx5 (safe for use in bathrooms). Oil filled. Class 1. CE Approved

## Pipe Centres and Technical Drawings

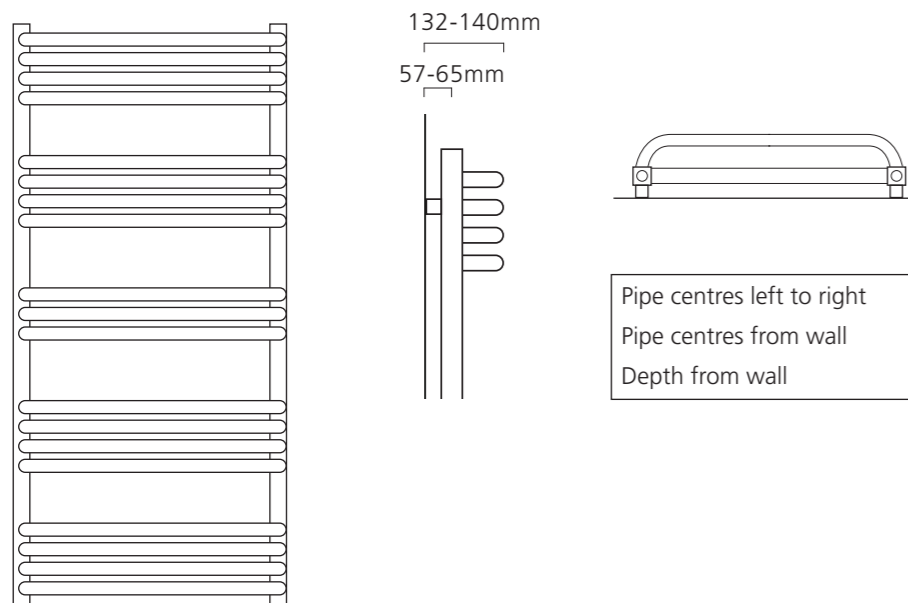

Pipe centres left to right = Width less 40mm  
 Pipe centres from wall = 57mm - 65mm  
 Depth from wall = 132mm - 140mm



Electric sizes available

+Valves Prices include angled chrome DRAKE Valves.



Please specify at time of order



RAL 7016 Anthracite Grey.



◆ APSLEY Towel Rail 1300mm x 600mm in Carbon shown with LIVINGSTONE Valves.



# WINSFORD Ladder Rail



- Italian design & manufacture, steel ladder rail, 25mm straight cross tubes
- White RAL 9016 as standard delivered in 48-72 hours
- 23 RAL colours, 10 special finishes, up to 8 working days (pg.12-13)
- Optional next-day delivery available (pg.2)
- Stocked textured anthracite & matt black sizes delivered in 48-72 hours
- Dual fuel available, please specify at time of order

## Sizes and Prices

Please add 10% to the RAL colour price to work out your special finish price.

Dimensions (mm)		Cross Tubes	Output Δt 50°C		Product Code	White Ex VAT	White Inc VAT	RAL Colour Ex VAT	RAL Colour Inc VAT	White +Valves Ex VAT	White +Valves Inc VAT	RAL Colour +Valves Ex VAT	RAL Colour +Valves Inc VAT
Height	Width		Watts	Btu's									
759	500	12	332	1133	WINS755012	£91.00	£109.20	£211.00	£253.20	£120.00	£144.00	£240.00	£288.00
	600	12	388	1324	WINS756012	£107.00	£128.40	£246.00	£295.20	£136.00	£163.20	£275.00	£330.00
964	500	15	404	1378	WINS965015	£101.00	£121.20	£226.00	£271.20	£130.00	£156.00	£255.00	£306.00
	600	15	471	1607	WINS966015	£124.00	£148.80	£280.00	£336.00	£153.00	£183.60	£309.00	£370.80
1374	500	21	578	1972	WINS135021	£120.00	£144.00	£275.00	£330.00	£149.00	£178.80	£304.00	£364.80
	600	21	674	2300	WINS136021	£144.00	£172.80	£362.00	£434.40	£173.00	£207.60	£391.00	£469.20

\*\*Valves Prices include angled chrome DRAKE Valves, please specify at time of order if you require straight valves.

The WINSFORD Ladder Rail is suitable for use as dual fuel, please see pages 98-99 for available Electric Elements.

## STOCKED TEXTURED ANTHRACITE & MATT BLACK SIZES AVAILABLE FOR DELIVERY IN 48-72 HOURS

Dimensions (mm)		Cross Tubes	Output Δt 50°C		Product Code	Price Ex VAT	Price Inc VAT	Price +Valves Ex VAT	Price +Valves Inc VAT
Height	Width		Watts	Btu's					
<b>Textured Anthracite</b>									
759	500	12	332	1133	WINS755012TA	£151.00	£181.20	£250.00	£300.00
964		15	404	1378	WINS965015TA	£163.00	£195.60	£262.00	£314.40
1374		21	578	1972	WINS135021TA	£196.00	£235.20	£295.00	£354.00
<b>Matt Black</b>									
759	500	12	332	1133	WINS755012MB	£151.00	£181.20	£250.00	£300.00
964		15	404	1378	WINS965015MB	£163.00	£195.60	£262.00	£314.40
1374		21	578	1972	WINS135021MB	£196.00	£235.20	£295.00	£354.00



Textured Anthracite



Matt Black

\*\*Valves Prices include matching angled SHELLEY Valves, please specify at time of order if you require straight valves.

The WINSFORD Ladder Rail is suitable for use as dual fuel, please see pages 98-99 for available Electric Elements.

## Pipe Centres and Technical Drawings

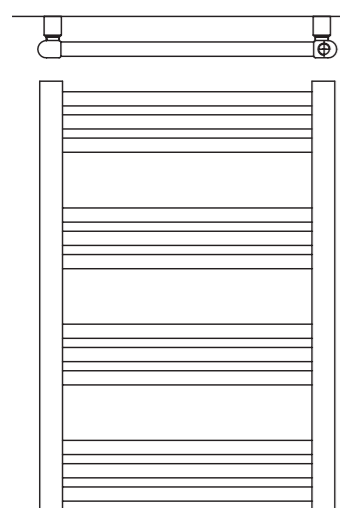

72mm - 82mm  
57mm - 67mm

Pipe centres left to right = Width less 44mm  
Pipe centres from wall = 57mm - 67mm  
Depth from wall = 72mm - 82mm



+Valves Prices include angled chrome DRAKE or matching SHELLEY Valves.

Please specify at time of order



1374 x 600  
in White RAL 9016



◆ WINSFORD Ladder Rail 1374mm x 500mm in Textured Anthracite shown with matching SHELLEY Valves.



# ARGYLL

- Steel towel rail with 22mm straight or curved cross tubes in hydronic
- Electric oil-filled versions available with straight cross tubes only
- Chrome finish, delivered as standard in 48-72 hours
- Optional next-day delivery available (pg. 2)
- Dual fuel available, please specify at time of order



## Hydronic Sizes and Prices

Dimensions (mm)		Cross Tubes	Output Δt 50°C		Product Code	Chrome Ex VAT	Chrome Inc VAT	Chrome +Valves Ex VAT	Chrome +Valves Inc VAT
Height	Width		Watts	Btu's					
<b>Straight</b>									
800	400	14	209	713	ARGS804014C	£130.00	£156.00	£159.00	£190.80
	500	14	252	860	ARGS805014C	£137.00	£164.40	£166.00	£199.20
	600	14	295	1007	ARGS806014C	£147.00	£176.40	£176.00	£211.20
1200	400	21	313	1068	ARGS124021C	£169.00	£202.80	£198.00	£237.60
	500	21	378	1290	ARGS125021C	£174.00	£208.80	£203.00	£243.60
	600	21	443	1512	ARGS126021C	£183.00	£219.60	£212.00	£254.40
1800	500	32	558	1904	ARGS185032C	£248.00	£297.60	£277.00	£332.40
	600	32	654	2231	ARGS186032C	£259.00	£310.80	£288.00	£345.60
<b>Curved</b>									
800	500	14	252	860	ARGC805014C	£140.00	£168.00	£169.00	£202.80
	600	14	295	1007	ARGC806014C	£152.00	£182.40	£181.00	£217.20
1200	500	21	378	1290	ARGC125021C	£183.00	£219.60	£212.00	£254.40
	600	21	443	1512	ARGC126021C	£190.00	£228.00	£219.00	£262.80
1800	500	32	558	1904	ARGC185032C	£263.00	£315.60	£292.00	£350.40
	600	32	654	2231	ARGC186032C	£273.00	£327.60	£302.00	£362.40

\*+Valves Prices include angled chrome DRAKE Valves, please specify at time of order if you require straight valves.  
The ARGYLL is suitable for use as dual fuel, please see pages 98-99 for available Electric Elements.

## Electric Straight Sizes and Prices

Supplied as standard with Element A see page 98 for details

Dimensions (mm)		Cross Tubes	Output Δt 50°C Watts	Product Code	Chrome Ex VAT	Chrome Inc VAT
Height	Width					
<b>Straight</b>						
600	400	12	150	ARGS6040EC	£180.00	£216.00
800	500	14	200	ARGS8050EC	£218.00	£261.60
1200	500	20	300	ARGS1250EC	£282.00	£338.40
1600	500	26	500	ARGS1650EC	£338.00	£405.60
1800	600	30	600	ARGS1860EC	£407.00	£488.40

ARGYLL Electric depth from wall = 80mm

## Element A (2-year guarantee)

- A simple, entry-level element, with a fixed stainless head
- 1 fixed heat setting of 65°C regulating the internal radiator temperature
- Power supply controlled from switched fused spur (no power button on the element itself)
- IP67. Class 1. Element fitted on the right-hand side.
- Guarantee - 2 years

## ARGYLL Hydronic Pipe Centres and Technical Drawings

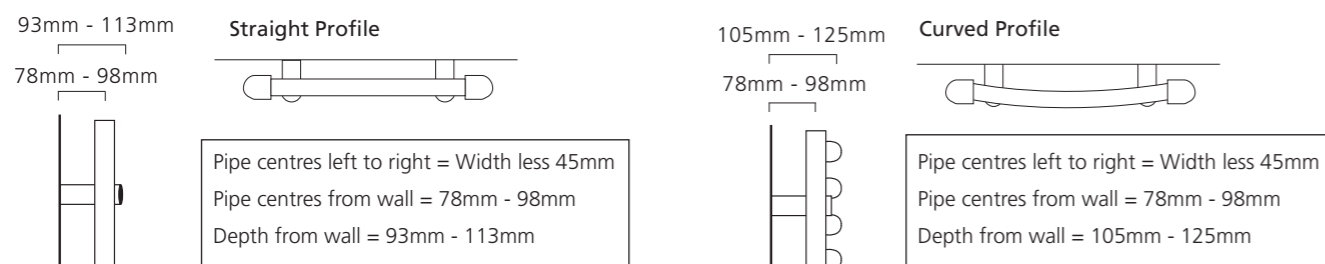

◆ ARGYLL Electric Straight 1200mm x 500mm 300 watts.



# ASHBY Ladder Rail

- Italian design & manufacture
- Steel ladder rail with 50mm x 10mm cross tubes
- +Valves prices include chrome DRAKE valves\*
- Standard white RAL 9016 delivered in 48-72 hours
- Optional next-day delivery available in white RAL 9016 (pg. 2)
- 23 RAL colours, 10 special finishes, up to 8 working days (pg.12-13)
- Dual fuel available, please specify at time of order



+Valves Prices include angled chrome DRAKE Valves

Please specify at time of order

## Sizes and Prices

Please add 10% to the RAL colour price to work out your special finish price.

Dimensions (mm)		Cross Tubes	Output Δt 50°C		Product Code	White Ex VAT	White Inc VAT	RAL Colour Ex VAT	RAL Colour Inc VAT	White +Valves Ex VAT	White +Valves Inc VAT	RAL Colour +Valves Ex VAT	RAL Colour +Valves Inc VAT
Height	Width		Watts	Btu's									
940	500	9	383	1307	ASHB945009 ♦	£221.00	£265.20	£326.00	£391.20	£250.00	£300.00	£355.00	£426.00
	600	9	430	1467	ASHB946009	£222.00	£266.40	£351.00	£421.20	£251.00	£301.20	£380.00	£456.00
1290	500	12	526	1795	ASHB125012	£243.00	£291.60	£373.00	£447.60	£272.00	£326.40	£402.00	£482.40
	600	12	590	2013	ASHB126012	£244.00	£292.80	£415.00	£498.00	£273.00	£327.60	£444.00	£532.80
1640	500	15	669	2283	ASHB165015	£291.00	£349.20	£454.00	£544.80	£320.00	£384.00	£483.00	£579.60
	600	15	749	2556	ASHB166015	£292.00	£350.40	£507.00	£608.40	£321.00	£385.20	£536.00	£643.20

\*+Valves Prices include angled chrome DRAKE Valves, please specify at time of order if you require straight valves. The ASHBY Ladder Rail is suitable for use as dual fuel, please see pages 98-99 for available Electric Elements.

## Pipe Centres and Technical Drawings

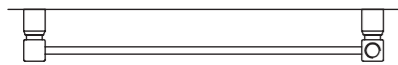

72mm - 82mm

57mm - 67mm

Pipe centres left to right = Width less 30mm  
 Pipe centres from wall = 57mm - 67mm  
 Depth from wall = 72mm - 82mm

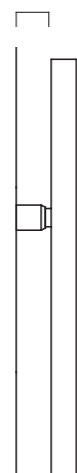
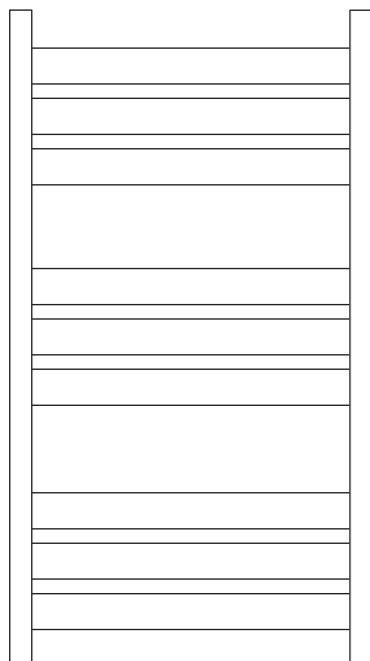

1640mm x 500mm in RAL 9004 Signal Black



♦ 940mm x 500mm in White RAL 9016 shown with DRAKE Valves.



# MILTON Towel Rail

- Steel towel rail; 50mm x 10mm cross tubes
- 30mm x 30mm square collectors
- +Valves prices include chrome DRAKE valves\*
- Standard white RAL 9016 delivered in 48-72 hours
- Optional next-day delivery available in White RAL 9016 (pg. 2)
- 23 RAL colours, 10 special finishes, up to 8 working days (pg.12-13)
- Dual fuel available, please specify at time of order



## Sizes and Prices

Please add 10% to the RAL colour price to work out your special finish price.

Dimensions (mm)		Cross Tubes	Output Δt 50°C		Product Code	White Ex VAT	White Inc VAT	RAL Colour Ex VAT	RAL Colour Inc VAT	White +Valves Ex VAT	White +Valves Inc VAT	RAL Colour +Valves Ex VAT	RAL Colour +Valves Inc VAT
Height	Width		Watts	Btu's									
655	500	8	325	1109	MILT655008	£239.00	£286.80	£333.00	£399.60	£268.00	£321.60	£362.00	£434.40
	600	8	383	1307	MILT656008	£251.00	£301.20	£336.00	£403.20	£280.00	£336.00	£365.00	£438.00
785	500	10	400	1365	MILT785010	£276.00	£331.20	£368.00	£441.60	£305.00	£366.00	£397.00	£476.40
	600	10	470	1604	MILT786010	£290.00	£348.00	£373.00	£447.60	£319.00	£382.80	£402.00	£482.40
915	500	12	475	1621	MILT915012	£312.00	£374.40	£404.00	£484.80	£341.00	£409.20	£433.00	£519.60
	600	12	555	1894	MILT916012	£329.00	£394.80	£418.00	£501.60	£358.00	£429.60	£447.00	£536.40
1110	500	14	553	1887	MILT115014	£349.00	£418.80	£454.00	£544.80	£378.00	£453.60	£483.00	£579.60
	600	14	650	2218	MILT116014 ♦	£385.00	£462.00	£490.00	£588.00	£414.00	£496.80	£519.00	£622.80

\*+Valves Prices include angled chrome DRAKE Valves, please specify at time of order if you require straight valves. The MILTON Towel Rail is suitable for use as dual fuel, please see pages 98-99 for available Electric Elements.

## Pipe Centres and Technical Drawings

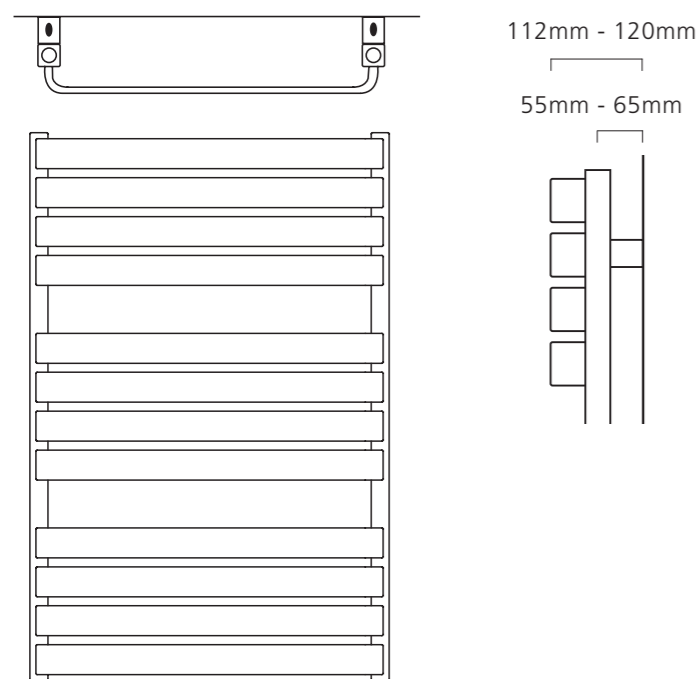

Pipe centres left to right = Width less 30mm  
 Pipe centres from wall = 57mm - 65mm  
 Depth from wall = 112mm - 120mm



RAL 9005 Jet Black

+Valves Prices include angled chrome DRAKE Valves



Please specify at time of order



655mm x 500mm in White RAL 9016

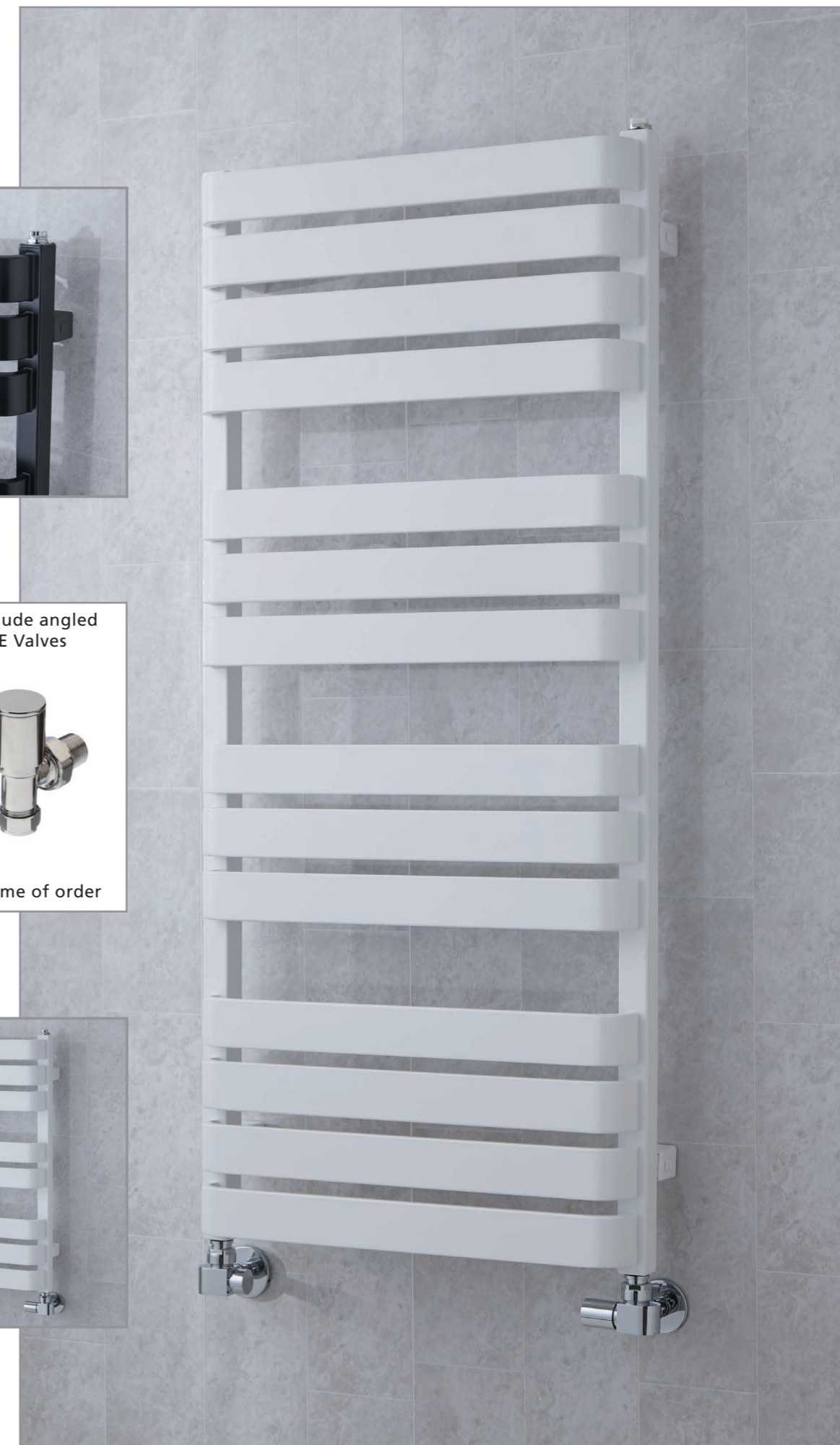

♦ 1110mm x 600mm in White RAL 9016 shown with DARWIN Valves.



# LANARK Stainless Steel



- 22mm cross tubed stainless steel towel rail
- Polished stainless steel finish delivered in 48-72 hours
- Suitable for direct systems
- Optional next-day delivery available (pg.2)
- Dual fuel available, please specify at time of order

## Sizes and Prices

Dimensions (mm)		Cross Tubes	Output Δt 50°C		Product Code	Price Ex VAT	Price Inc VAT	Price +Valves Ex VAT	Price +Valves Inc VAT
Height	Width		Watts	Btu's					
<b>Straight</b>									
800	500	12	198	676	LANS8050SS	£394.00	£472.80	£423.00	£507.60
	600	12	233	795	LANS8060SS	£431.00	£517.20	£460.00	£552.00
1200	500	18	314	1071	LANS1250SS	£532.00	£638.40	£561.00	£673.20
	600	18	371	1266	LANS1260SS	£595.00	£714.00	£624.00	£748.80
<b>Curved</b>									
800	500	12	198	676	LANC8050SS	£426.00	£511.20	£455.00	£546.00
	600	12	233	795	LANC8060SS	£468.00	£561.60	£497.00	£596.40
1200	500	18	314	1071	LANC1250SS	£605.00	£726.00	£634.00	£760.80
	600	18	371	1266	LANC1260SS	£637.00	£764.40	£666.00	£799.20

\*+Valves Prices include angled chrome DRAKE Valves, please specify at time of order if you require straight valves.  
The LANARK is suitable for use as dual fuel, please see pages 98-99 for available Electric Elements.

## Pipe Centres and Technical Drawings

### Straight Ladder Rail

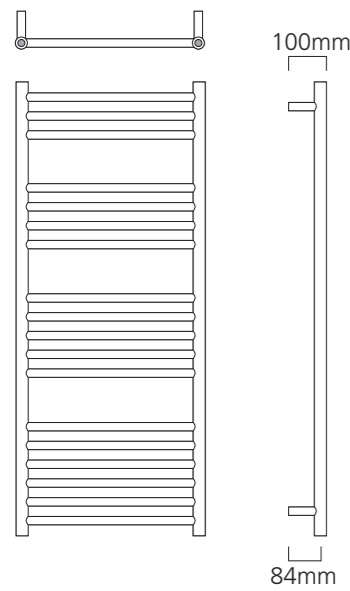

### Curved Ladder Rail

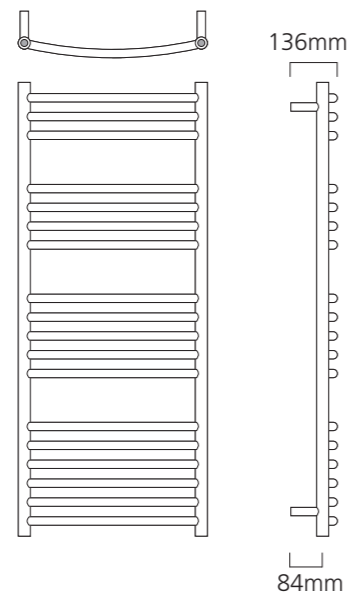

**Lanark Straight**  
 Pipe centres left to right = Width less 32mm  
 Pipe centres from wall = 84mm  
 Depth from wall = 100mm

**Lanark Curved**  
 Pipe centres left to right = Width less 32mm  
 Pipe centres from wall = 84mm  
 Depth from wall = 136mm



### Stainless Steel Cleaning Glove

Description	Product Code	Price Ex VAT	Price Inc VAT
Stainless Steel Cleaning Glove	STSGLOV	£11.00	£13.20



LANARK Curved option



LANARK with Dual Fuel option



◆ LANARK Straight 1200mm x 500mm shown with DRAKE Valves.



# CLEVES

- Classic steel towel rail in chrome
- Floor or wall mounted options, delivered in 48-72 hours
- Optional next-day delivery available (pg.2)
- Dual fuel available, please specify at time of order

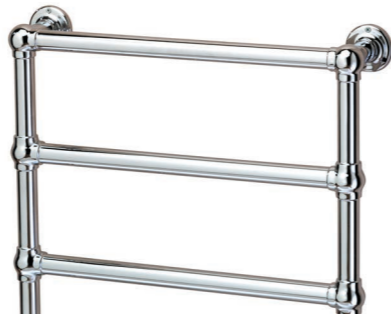

## Sizes and Prices

Dimensions (mm)			Cross Tubes	Output Δt 50°C		Product Code	Chrome Ex VAT	Chrome Inc VAT	Chrome +Valves Ex VAT	Chrome +Valves Inc VAT
Height	Width	Depth		Watts	Btu's					
<b>Wall Mounted</b>										
750	500	125	4	137	467	CLEV75504C	£523.00	£627.60	£562.00	£674.40
<b>Floor Standing</b>										
848	598	137	4	163	556	CLEV845904C	£540.00	£648.00	£579.00	£694.80
1548	598	144	5	310	1058	CLEV155905C	£656.00	£787.20	£695.00	£834.00

\*+Valve Prices include Chrome WILLOW Valves, angled only.

The CLEVES is suitable for use as dual fuel, please see pages 98-99 for available Electric Elements.

## Supplement Prices for Dual Fuel Option

Description	Product Code	Price Ex VAT	Price Inc VAT
100W Dual Energy Element (for Wall Mounted Rail)	100WDEELE	£62.00	£74.40
100W Dual Energy Element (for Floor Standing Rail 848 x 598)	100WDEELE	£62.00	£74.40
150W Dual Energy Element (for Floor Standing Rail 1548 x 598)	150WDEELE	£63.00	£75.60

Please Note: Elements have an IP rating of 55 and are guaranteed for 2 years.

## Pipe Centres and Technical Drawings

### Wall Mounted 750mm high

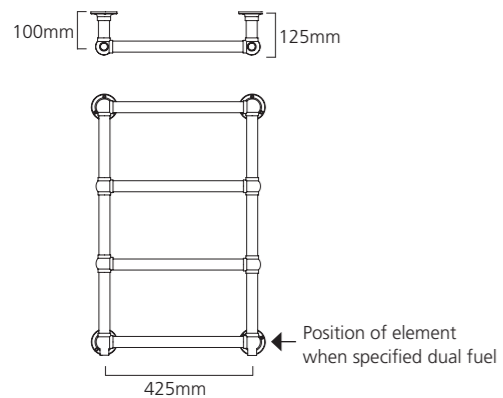

Pipe centres left to right = Width less 75mm  
 Pipe centres from wall = 100mm  
 Depth from wall = 125mm

### Floor Standing 848mm high

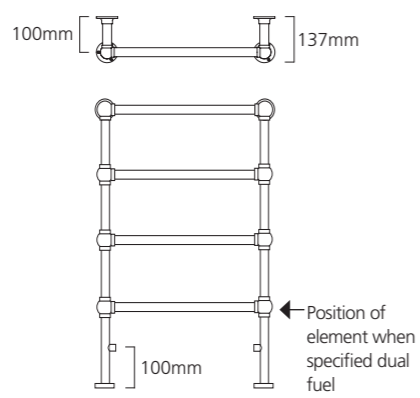

Pipe centres left to right = Width less 145mm less valves  
 Pipe centres from wall = 848mm high = 100mm, 1548mm high = 107mm  
 Depth from wall = 848mm high = 137mm, 1548mm high = 144mm

### Floor Standing 1548mm high

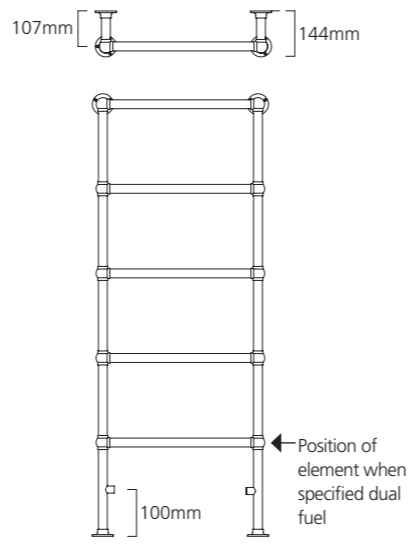

Floor Standing option

+Valves Prices include chrome WILLOW Valves



Please specify at time of order



Wall Mounted option

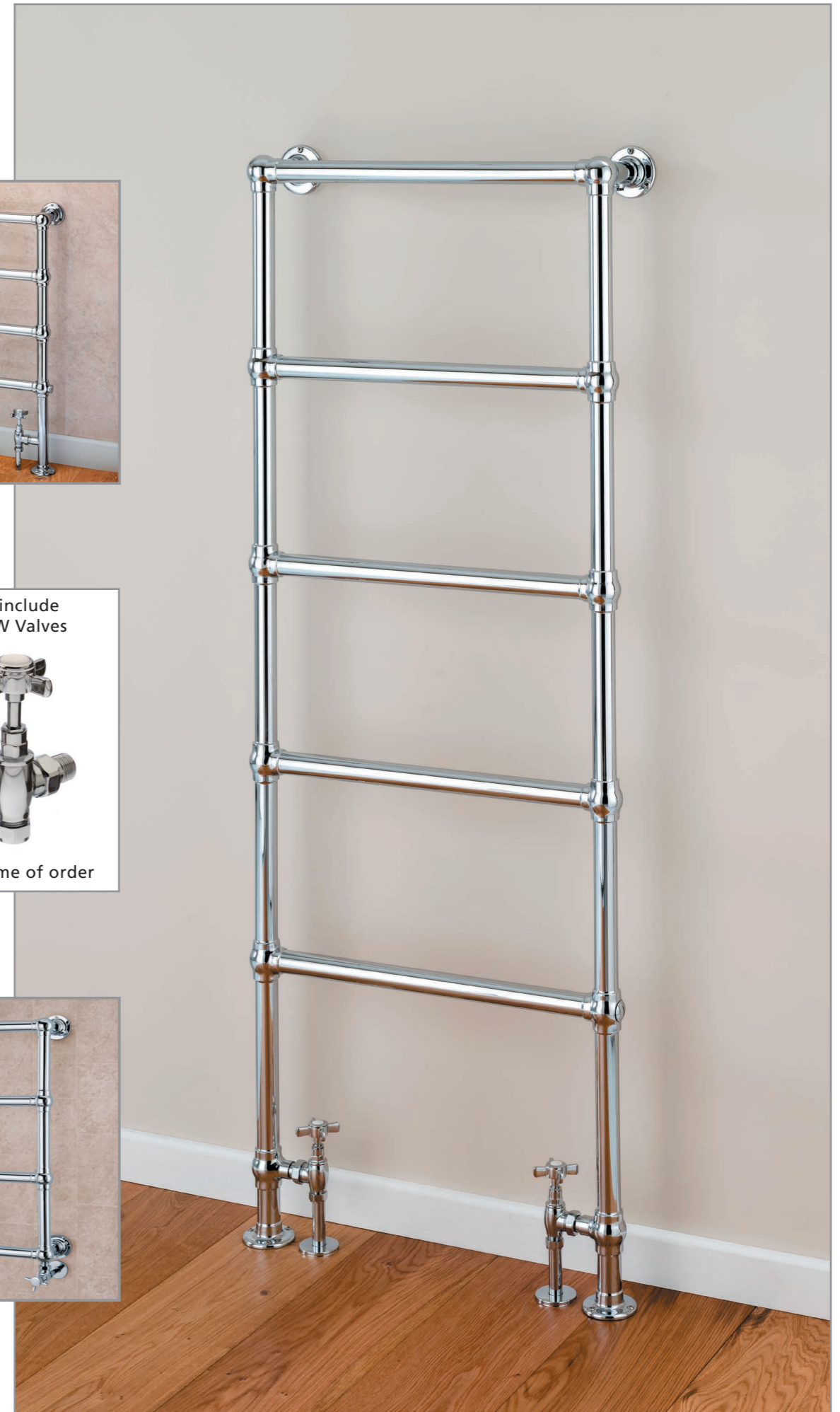

◆ CLEVES Floor Standing 1548mm x 598mm shown with WILLOW Valves.



# BOLEYN

- Classic steel towel rail with a steel multi column radiator
- Chrome with white RAL 9016 multi column sections
- Standard delivery 48-72 hours
- Optional next-day delivery available (pg.2)
- Dual fuel option available, please specify at time of order



## Sizes and Prices

Dimensions (mm)			Sections	Output Δt 50°C		Product Code	Price Ex VAT	Price Inc VAT	Price +Valves Ex VAT	Price +Valves Inc VAT
Height	Width	Depth		Watts	Btu's					
<b>Floor Standing</b>										
965	540	230	5	392	1338	BOLE965405	£565.00	£678.00	£604.00	£724.80
	673	230	8	554	1890	BOLE966708	£672.00	£806.40	£711.00	£853.20
	765	230	10	653	2228	BOLE967610	£771.00	£925.20	£810.00	£972.00
<b>Wall Mounted</b>										
740	675	250	8	568	1938	BOLE746708	£787.00	£944.40	£826.00	£991.20

\*+Valve Prices include Chrome WILLOW Valves, angled only.

The BOLEYN is suitable for use as dual fuel, please see pages 98-99 for available Electric Elements.

## Supplement Prices for Dual Fuel Option

Description	Product Code	Price Ex VAT	Price Inc VAT
200W Dual Energy Element (for 5 Section Rail)	200WDEELE	£63.00	£75.60
400W Dual Energy Element (for 8 & 10 Section Rail)	400WDEELE	£72.00	£86.40

Please Note: Elements have an IP rating of 55 and are guaranteed for 2 years.

## Pipe Centres and Technical Drawings

### Boleyn Floor Standing

Pipe centres left to right = Width less 145mm less valves  
 Pipe centres from wall = 92mm  
 Depth from wall = 230mm

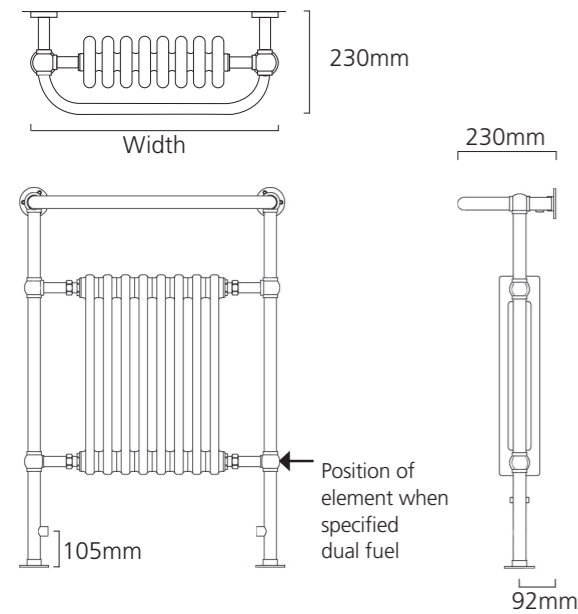

### Boleyn Wall Mounted

Pipe centres left to right = Width less 75mm  
 Pipe centres from wall = 50mm  
 Depth from wall = 250mm

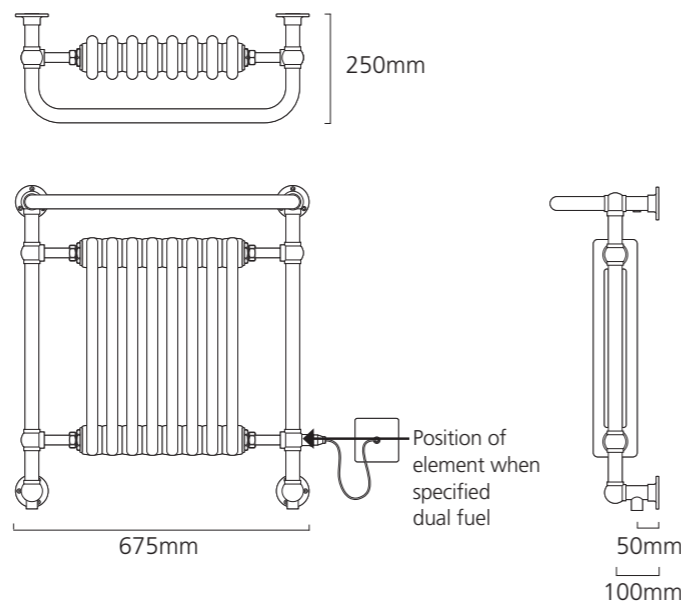

BOLEYN Wall Mounted option available

+Valves Prices include chrome WILLOW Valves



Please specify at time of order



Dual Fuel option available



◆ BOLEYN Floor Standing 965mm x 765mm shown with WILLOW Valves.



# TRV VALVES & VALVE KITS

Please note all valves are sold in pairs - Lockshield & Wheelhead. Angled versions will be supplied as standard, if you require a Straight pair please specify at time of order. These valves are not Bi-directional.



## TOWER TRV

For angled valves allow an extra 80mm in total.



Textured Anthracite Angled

Product Code	Price Ex VAT	Price Inc VAT
TOWEANTRVTA	£174.00	£208.80

Textured Anthracite Straight

Product Code	Price Ex VAT	Price Inc VAT
TOWESTTRVTA	£174.00	£208.80

## KINGSTON TRV ANGLED

For angled valves allow an extra 80mm in total.



White

Chrome

Nickel



Antique Brass

Antique Copper

Description	Product Code	Price Ex VAT	Price Inc VAT
Kingston TRV Valve - White	KINGANTRVW	£72.00	£86.40
Kingston TRV Valve - Chrome	KINGANTRVC	£83.00	£99.60
Kingston TRV Valve - Nickel	KINGANTRVN	£118.00	£141.60
Kingston TRV Valve - Antique Brass	KINGANTRVAB	£118.00	£141.60
Kingston TRV Valve - Antique Copper	KINGANTRVAC	£118.00	£141.60

## KINGSTON TRV STRAIGHT



Nickel Straight (shown above)

Description	Product Code	Price Ex VAT	Price Inc VAT
Kingston TRV Valve - White	KINGSTTRVW	£72.00	£86.40
Kingston TRV Valve - Chrome	KINGSTTRVC	£83.00	£99.60
Kingston TRV Valve - Nickel	KINGSTTRVN	£121.00	£145.20
Kingston TRV Valve - Antique Brass	KINGSTTRVAB	£121.00	£145.20
Kingston TRV Valve - Antique Copper	KINGSTTRVAC	£121.00	£145.20

## WELLINGTON TRV



White Angled

Product Code	Price Ex VAT	Price Inc VAT
WELLANTRVW	£83.00	£99.60

Chrome Angled

Product Code	Price Ex VAT	Price Inc VAT
WELLANTRVC	£83.00	£99.60

White Straight

Product Code	Price Ex VAT	Price Inc VAT
WELLSTRVW	£83.00	£99.60

Chrome Straight

Product Code	Price Ex VAT	Price Inc VAT
WELLSTRVC	£83.00	£99.60

For angled valves allow an extra 80mm in total.

## WELLINGTON TRV KITS

Wellington TRV Kits include; Lockshield & Wheelhead in Chrome or White with Chrome or White Pipe Covers & Shrouds.



Chrome Angled

Product Code	Price Ex VAT	Price Inc VAT
WELLANKITC	£113.00	£135.60
WELLANKITW	£113.00	£135.60

White Straight

Product Code	Price Ex VAT	Price Inc VAT
WELLSTKITC	£113.00	£135.60
WELLSTKITW	£113.00	£135.60

Allow an extra 80mm in total.

Save money when you buy the Wellington TRV and Pipe Covers and Shroud as a kit.

## SHIRE TRV

For angled valves allow an extra 80mm in total.



Brass Angled

Angled / Straight	Product Code	Price Ex VAT	Price Inc VAT
Angled	SHIRANTRVBR	£111.00	£133.20
Straight	SHIRSTTRVBR	£116.00	£139.20

Brass Straight

Chrome Angled

Angled / Straight	Product Code	Price Ex VAT	Price Inc VAT
Angled	SHIRANTRVC	£111.00	£133.20
Straight	SHIRSTTRVC	£116.00	£139.20

Chrome Straight



# TRADITIONAL THERMOSTATIC VALVES



Please note all valves are sold in pairs - Lockshield & Wheelhead. Angled versions will be supplied as standard, if you require a Straight pair please specify at time of order. These valves are not Bi-directional.

## BELSAY TRV

Angled only - allow an extra 80mm in total.



Antique Brass (Walnut top)

Product Code	Price Ex VAT	Price Inc VAT
NBELSANTRVAB	£96.00	£115.20



Chrome (Walnut top)

Product Code	Price Ex VAT	Price Inc VAT
NBELSANTRVC	£96.00	£115.20



Satin Nickel (Black top)

Product Code	Price Ex VAT	Price Inc VAT
NBELSANTRVSN	£96.00	£115.20



Antique Copper (Black top)

Product Code	Price Ex VAT	Price Inc VAT
NBELSANTRVAC	£96.00	£115.20



Pewter (Black top)

Product Code	Price Ex VAT	Price Inc VAT
NBELSANTRVP	£96.00	£115.20

Our dark pewter finish is perfect for traditional and industrial chic interiors.

## BELSAY TRV - CORNER RANGE

Angled only - allow an extra 60mm in total.



Corner Antique Brass (Walnut top)

Product Code	Price Ex VAT	Price Inc VAT
NBELSCOTRVAB	£122.00	£146.40



Corner Satin Nickel (Black top)

Product Code	Price Ex VAT	Price Inc VAT
NBELSCOTRVSN	£122.00	£146.40

Belsay Corner TRVs are supplied as right handed return angled valves only. They will suit radiators which have the flow connection on the right side.

# MANUAL VALVES & VALVE KITS



Please note all valves are sold in pairs - Lockshield & Wheelhead. Angled versions will be supplied as standard, if you require a Straight pair please specify at time of order. These valves are not Bi-directional.

## SHELLEY New



Matt Black Angled

Matt Black Straight

Textured Anthracite Angled

Textured Anthracite Straight

Angled / Straight	Product Code	Price Ex VAT	Price Inc VAT
Angled	SHELANROUMB	£107.00	£128.40
Straight	SHELSTROUMB	£107.00	£128.40

Angled / Straight	Product Code	Price Ex VAT	Price Inc VAT
Angled	SHELANROUTA	£107.00	£128.40
Straight	SHELSTROUTA	£107.00	£128.40

Angled only - allow an extra 80mm in total.

Angled only - allow an extra 80mm in total.

## DARWIN



Product Code	Price Ex VAT	Price Inc VAT
DARCORNC	£72.00	£86.40

Angled only - allow an extra 90mm in total.

## LIVINGSTONE



Product Code	Price Ex VAT	Price Inc VAT
LIVIANXHEADMC	£50.00	£60.00

Angled only - allow an extra 80mm in total.

## WILLOW



Product Code	Price Ex VAT	Price Inc VAT
WILLANXHEADMC	£55.00	£66.00

Angled only - allow an extra 80mm in total.

## DRAKE



Angled

Straight

Angled / Straight	Product Code	Price Ex VAT	Price Inc VAT
Angled	DRAKANROUMC	£42.00	£50.40
Straight	DRAKSTROUMC	£42.00	£50.40

Allow an extra 70mm in total.

## DRAKE KITS

Drake Kit includes Lockshield & Wheelhead with Chrome Pipe Covers & Shrouds.



Angled

Straight

Save money when you buy the Drake, Pipe Covers & Shroud as a kit.

Angled / Straight	Product Code	Price Ex VAT	Price Inc VAT
Angled	DRAKANKITC	£67.00	£80.40
Straight	DRAKSTKITC	£67.00	£80.40

Allow an extra 70mm in total.



# ACCESSORIES



## AIRVENT & BLANKING PLUGS

Co-ordinate with your radiator & valve to create the perfect finish.



Antique Brass

Product Code	Price Ex VAT	Price Inc VAT
AIRVENTKITAB	£16.00	£19.20



Nickel

Product Code	Price Ex VAT	Price Inc VAT
AIRVENTKITN	£16.00	£19.20



Antique Copper

Product Code	Price Ex VAT	Price Inc VAT
AIRVENTKITAC	£16.00	£19.20



Chrome

Product Code	Price Ex VAT	Price Inc VAT
AIRVENTKITC	£16.00	£19.20

## PIPE COVERS & SHROUDS

Creating a neat finish for your radiator.



Chrome

Product Code	Price Ex VAT	Price Inc VAT
PIPCOVSHRC	£39.00	£46.80



White

Product Code	Price Ex VAT	Price Inc VAT
PIPCOVSHRW	£39.00	£46.80



Nickel

Product Code	Price Ex VAT	Price Inc VAT
PIPCOVSHRN	£39.00	£46.80



Antique Copper

Product Code	Price Ex VAT	Price Inc VAT
PIPCOVSHRAC	£39.00	£46.80



Antique Brass

Product Code	Price Ex VAT	Price Inc VAT
PIPCOVSHRAB	£39.00	£46.80

## RADSNAPS

Plastic pipe covers; cut to size and clip on.

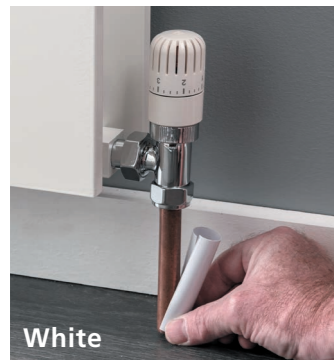

White



Description	Product Code	Price Ex VAT	Price Inc VAT
3 x 1 Metre White	RADSNAPWH	£16.00	£19.20

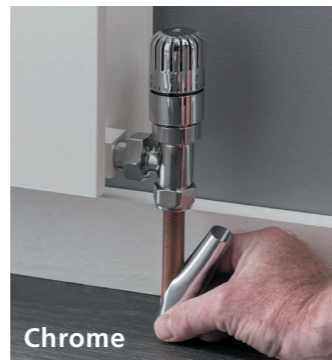

Chrome



Description	Product Code	Price Ex VAT	Price Inc VAT
3 x 1 Metre Chrome	RADSNAPCH	£19.00	£22.80

# ACCESSORIES



## HANGING BARS FOR CHAUCER, WINSFORD & ARGYLL



Description	Suitable for use with	Product Code	Price Ex VAT	Price Inc VAT
White Universal Hanging Bar 370mm	Chaucer Single Horizontal, Winsford	UNIHB370W	£92.00	£110.40
Chrome Universal Hanging Bar 370mm	Argyll Straight, Chaucer Single Horizontal, Winsford	UNIHB370C	£170.00	£204.00
White Universal Hanging Bar 480mm	Chaucer Single Horizontal	UNIHB480W	£92.00	£110.40
Chrome Universal Hanging Bar 480mm	Chaucer Single Horizontal	UNIHB480C	£171.00	£205.20

## SAXON HANGING BARS



Description / Minimum number of sections to fit	Product Code	Price Ex VAT	Price Inc VAT
White Hanging Bar 320mm / minimum of 6 sections to fit	SAXHHB320W	£70.00	£84.00
Chrome Hanging Bar 320mm / minimum of 6 sections to fit	SAXHHB320C	£79.00	£94.80
White Hanging Bar 480mm / minimum of 8 sections to fit	SAXHHB480W	£70.00	£84.00
Chrome Hanging Bar 480mm / minimum of 8 sections to fit	SAXHHB480C	£79.00	£94.80

## SAXON HANGING PEGS

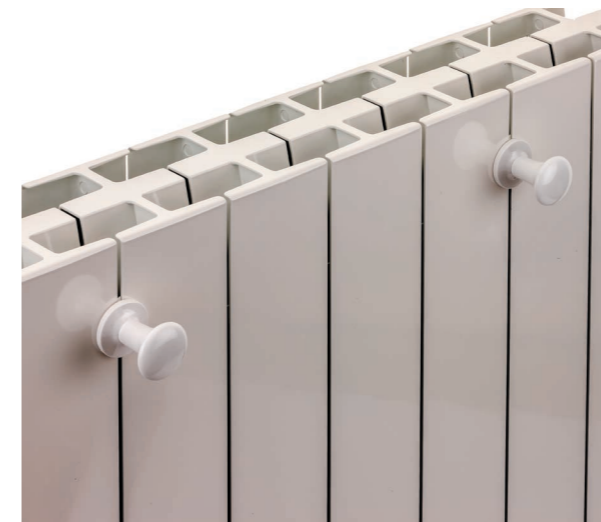

Description	Product Code	Price Ex VAT	Price Inc VAT
White Hanging Peg (each)	SAXHHPW	£25.00	£30.00
Chrome Hanging Peg (each)	SAXHHPCH	£30.00	£36.00



# ACCESSORIES - ELEMENTS



There are three types of element you can use with your towel rail; a manual electric element and two thermostatic electric elements. Use a T-Piece to enable the towel rail to be dual fuel - electric and hot water. Dual fuel valves and t-pieces can be found opposite.

## How to choose your Element

It is important to select the correct size element for your towel rail. Too small and it will not provide enough heat, too large and it can burn out.

The chart opposite will help you choose the right size element; we have listed the towel rail output in watts and the corresponding recommended size of element.

Towel Rail output range in Watts	Electric Elements
165 - 255	200w
260 - 375	300w
380 - 530	400w
535 - 735	600w
740 - 920	800w
920 - 1100	1000w

Description	Manual / Thermostatic	Output (Watts)	IP Rating	Product Code	Price Ex VAT	Price Inc VAT
Electric Element A - Stainless Steel with Grey Cable	Manual	150, 200, 300, 400, 500, 600, 800, 1000, 1200	IP67	ELEASS	£66.00	£79.20
Electric Element B - White with White Cable	Thermostatic	120, 200, 300, 400, 600, 800, 1000, 1200	IPX4	TELEBW	£103.00	£123.60
Electric Element B - Chrome with Grey Cable		120, 200, 300, 400, 600, 800, 1000, 1200	IPX4	TELEBC	£111.00	£133.20
Electric Element C - White with White Cable	Thermostatic	120, 200, 300, 400, 600, 800, 1000, 1200	IPX5	TELECW	£113.00	£135.60
Electric Element C - Chrome with Grey Cable		120, 200, 300, 400, 600, 800, 1000, 1200	IPX5	TELECC	£120.00	£144.00

## ELEMENT A (Manual Electric)

- A simple, entry-level element, with a fixed stainless head (superior to the loose plastic conical head models)
- 1 fixed heat setting of 65°C regulating the internal radiator temp Bimetal temperature limiter
- Power supply controlled from switched fused spur (no power button on the element itself)
- 26mm length from thread down
- Straight cable, no plug. IP67. Class 1
- Guarantee - 2 years



Stainless Steel with Grey Cable

## ELEMENT B (Thermostatic)

- 5 heat settings from 30°C to 60°C regulating the internal radiator temperature, denoted by 5 LEDs
- No timer
- Compatible with external Timer as remembers settings when switched off
- 55mm diameter clock shaped face
- 3x Buttons: Power, Temperature +/-
- Frost & overheating protection
- Straight cable, no plug. IPX4. Class 1
- Guarantee - 2 years



White with White Cable



Chrome with Grey Cable

# ACCESSORIES - ELEMENTS



## ELEMENT C (Thermostatic with 2 hour drying function)

- 5 heat settings from 30°C to 60°C regulating the internal radiator temperature, denoted by 5 LEDs
- No timer
- Compatible with external Timer as remembers settings when turned off
- 55mm diameter clock-shaped face
- 4x Buttons: Temperature +/-, Dryer, Power
- Frost & overheating protection
- Straight cable, no plug. IPX5. Class 1
- Guarantee - 2 years



White with White Cable



Chrome with Grey Cable

## CORNER TRV VALVE FOR DUAL FUEL

- This valve is ideal for dual fuel as it incorporates a TRV, Lockshield with an integrated T Piece, to accommodate the element
- Valve colour: Chrome

Description	Left Hand /Right Hand	Product Code	Price Ex VAT	Price Inc VAT
Corner TRV Valve for Dual Fuel - Chrome	Left Hand	CORNTRVLC	£208.00	£249.60
	Right Hand	CORNTRVRC	£208.00	£249.60



## T-PIECES

Description	Product Code	Price Ex VAT	Price Inc VAT
Chrome T-Piece 50mm	TPIECE50C	£12.00	£14.40
White T-Piece 50mm	TPIECE50W	£9.00	£10.80



White 50mm T-Piece



Chrome 50mm T-Piece

## CABLE MASKING COVER

Suitable with B & C elements only, please specify colour at time of order.

Description	Product Code	Price Ex VAT	Price Inc VAT
White Cable Masking Cover	MASKELEW	£7.00	£8.40
Silver Cable Masking Cover	MASKELES	£7.00	£8.40
Chrome Cable Masking Cover	MASKELEC	£8.00	£9.60



Chrome



White



Silver