



The Radiator Company



2024 Edition Brochure & Price List



Our Brochure is available through Easyquote software making quoting & ordering easier.



The largest selection of designer radiators and towel rails to suit any home interior.

Design

- Over 52 exclusive and affordable designs.
- Italian design & manufacture.
- Efficient low water content designs saving energy and reducing running costs.

Choice

- UK's largest brochure selection of radiators and towel rails.
- Over 1250 sizes and colours are available from stock, delivered in 48-72 hours.
- Thousands of Made to Order options in over 200 colours and special finishes.
- Sectional Specialists in Steel Multi Column, Aluminium and Cast Iron.

Service

- A dedicated UK Customer Service Team to make your purchase as smooth as possible.
- Order from our network of Plumbing & Heating Merchants including over 500 Showrooms nationwide.
- Free Delivery on all radiators and towel rails to UK mainland Showrooms and Merchants.
- Minimum 10-Year Guarantee on all radiators and towel rails.
- All radiators and towel rails are CE/UKCA approved and certified to BS EN442.

The Radiator Company is a brand of **IRSAP**, Italy's leading manufacturer of design led radiators.





Radiators

New For this edition pages 6-7

Steel Multi Column pages 8-29 / 128-147

	Product	Technical
	Ancona® Stock	8-17 128-137
	Ancona® Made to Order	18-25 138-143
	Ancona® Bench Seat	26-27 144-145
	Ancona® Curved	28 146
	Ancona® Electric	29 147

Contemporary Designer pages 30-61 / 148-173

	Product	Technical
●	Relax Hybrid	32 148-149
●	Polygon	33 151
●	Piano Electric	34 150
●	Sax Electric	35 150
	Ceramica Collection	36-37 152
	Torré	38-39 153
	Niro	40-41 153
	Iseo	42-43 154
	Sebino	44-45 155
	Canto	46 156
	Water Lily	47 157
	Piano	48-49 158-159
	Athena	50-51 172
	Relax	52-53 160-161
	Ellipsis	54-55 162-165
	Sitar	56-57 166-169
	Sax	58-59 170-171
	Halo	60-61 173

Sectional Aluminium pages 62-71 / 174-183

	Product	Technical
	Vip	64-65 176-177
	Oscar	66-67 178-179
	Vox	68-69 180-181
	Mix	70-71 182-183

Traditional Cast Iron pages 72-85 / 184-194

	Product	Technical
●	Ledbury	74-75 186
	Aston	76-77 185
●	Clifton	78-79 188
	Linton	80-81 190-191
●	Henley	82-83 192
	Stamford	84 194
●	Wentworth	85 193

®Ancona is a registered trademark of IRSAP UK Limited.

Towel Rails pages 86-113 / 195-213

	Product	Technical
	Step BDO	88 196
	Step	89 196
	Athena BDO	90 195
	Athena Towel Rail	91 195
	Relax Bagno	92 197
	Echo	93 198
●	Piano Towel Rail	94 199
●	Piano Lato / Electric	95 200
	Quadre	96 201
	Pulsar	97 202
●	Ellipsis Classic	98 203
	Ellipsis Towel Rail	99 203
●	Sitar BDO/Sitar Towel Rail	100 198/205
●	Sitar Lato/Sitar Lato Electric	101 204
	Poll BDO	102 206
	Poll	103 207
	Poppy	104-105 208
	Lupin	106-107 209
	Iris	108-109 210
	Blues	110 202
	Chalfont Range	111 212-213
	Lingfield	112 211
	Linton Towel Rail	113 211



Valves & Accessories pages 114-127

	Heating Elements	114-115
	Valves	116-125
●	NOW Smart Valves	118-119
	Accessories	126-127

Technical Details & Prices pages 128-213

To find your local showroom or merchant: **01342 302250** or visit theradiatorcompany.co.uk where you will also find helpful tools such as our **heat output (BTU) calculator** as well as our **curved** and **sectional radiator builder**.

Helpful Advice & How to Buy pages 214-215

RAL Colours & Colour Co-ordination pages 216-217

Index page 218

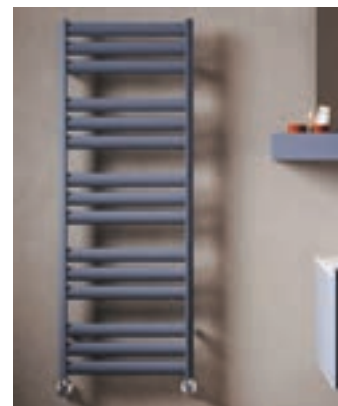
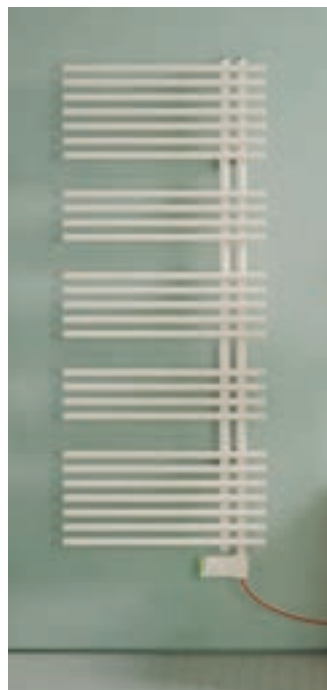

NEW Cast Iron Radiators

New

A new updated version of our Ledbury plus a collection of new cast iron radiators, the Clifton, reminiscent of 1930's school or hospital radiators, a simple and easy to clean design, the Henley and Wentworth, two ornate designs, one opulent and gothic the other channelling the arts and crafts movement.

All available in 188 RAL colours, Polished and Industrial finishes and 10 Classic Cast Iron Colours exclusive to these ranges.



Ledbury pages 74-75/186



Clifton pages 78-79/188



Henley pages 82-83/192



Wentworth pages 85/193

Classic Cast Iron Colours

Exclusive to these cast iron radiators, our specially selected colours reflect the heritage and traditions of cast iron from Victorian times to the modern day. Chosen with an eye on classic interiors these tough hard wearing and washable finishes add a stunning metallic look to your cast iron radiators.

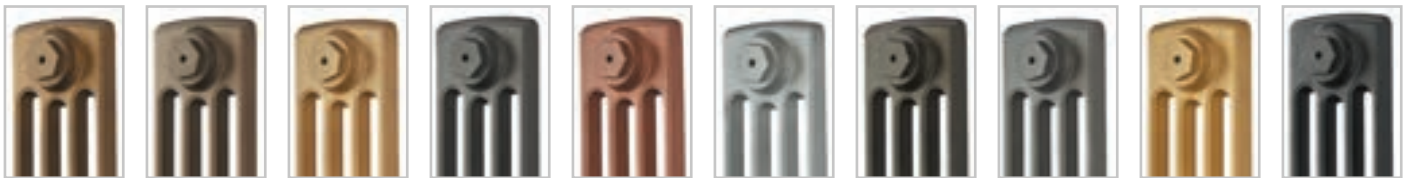

For samples of our Classic Cast Iron colours please call 01342 302250.

New Towel Rails

New

New for this edition we have an extension of our Sitar family the Sitar Towel Rail and Sitar Lato Electric. Neutral lines and classic design they look great in any Bathroom or Kitchen.

Ellipsis Classic – a standard ladder rail format with soft curved cross tubes in regular spaced groups of three.

New Double versions for the Piano Towel Rail mean increased outputs in the same amount of space.



Sitar Double Towel Rail pages 100/205

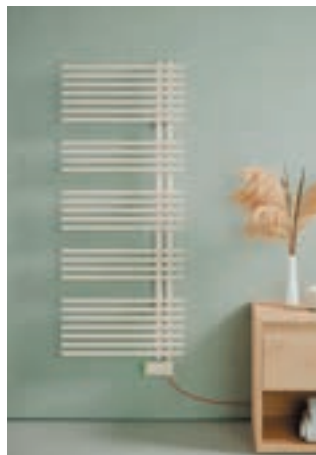

Sitar Lato Electric pages 101/204

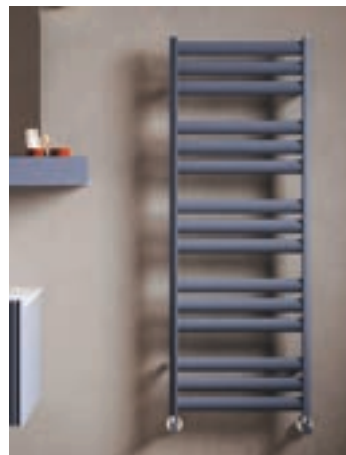

Ellipsis Classic pages 98/203



Piano Double Towel Rail pages 94/199

NEW Feature Finishes for stocked products

New

An exclusive collection of exciting and trending colours.

Our range of Feature Finishes are painted here in the UK and for this edition we are now able to offer these finishes on the majority of our stocked products. Please call 01342 302250 for sample swatches.



Vintage Green

A warm, deep pastel, shade of green. Reminiscent of the arts and crafts movement and Edwardian era, Vintage Green is a calming and relaxed tone.



Aged Brass

Bringing a luxurious touch to any room. Aged Brass has a sheen that highlights the depth of colour.



Satin Gold

Warm and deep, Satin Gold has a silky tactile finish, a perfect complement to the soft tones of many bathroom and kitchen taps and accessories.



Copper

A bright finish with red and gold tones, Copper is a very popular finish.



Textured Anthracite

This earthy near black/anthracite finish pairs well with many colour schemes, providing a sophisticated tone and nuance.



Pearl Bronze

A deep lustrous finish, the combination of darker and light tones creates a patina effect and an aged look.

Originally only available on our stock white Ancona models we have now extended them to all Sectional Aluminium and the majority of our stocked white Designer and Towel Rails. Please see individual product pages for more information.

These colours are top of the range, nuanced and striking. Painted in the UK they are usually delivered in 2 weeks (slightly longer for deliveries to off shore islands and furthest reaches of the Mainland).



Lupin in Satin Gold

Ancona® - Steel Multi Column

Italy, has earned an outstanding worldwide reputation for being at the leading edge of radiator design, style and practical functionality. Produced in our factory in Italy the Ancona® range of Steel Multi Column radiators take the classic look of cast iron and combines it with the flexibility of steel; suitable for all interiors. Multiple column depths, heights and widths provide an extensive choice of sizes and outputs to suit any room or location.

Stock pages 10-17

Our stylish and timeless stock Ancona® Steel Multi Column is held in our UK warehouse for fast delivery. The most popular 2, 3 or 4 column sizes in 5 height options and 3 mounting options are available from stock;

- White RAL 9016 delivered in 48-72 hours
- Bare Metal Lacquer delivered in 48-72 hours, 2 tinted lacquers in up to 2 weeks
- 6 Feature Finishes: Copper, Textured Anthracite, Pearl Bronze, Vintage Green, Aged Brass and Satin Gold all delivered in up to 2 weeks
- Colour Coordination service, price and lead time on application [see page 217](#)

We list all possible combinations on pages 130-137 in the technical section.



Made To Order pages 18-25

The perfect solution, made to order in our Italian factory to fit your requirements.

We offer a vast range of sizes of Ancona Multi Column in 2-6 column options; with 3 different mounting options wall-hung, cast feet or welded feet. Added to this, we have over 188 RAL colours plus 32 special finishes including Bare Metal Lacquer.

Combine all of these choices and you have over 3 million combinations of sizes, colours and mounting options. To help make selection easier please use our online radiator builder, a simple way to select the best size, options and heat requirements for your space.

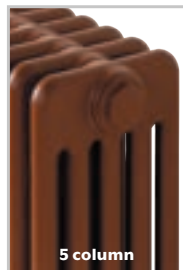

® Ancona is a registered trademark of IRSAP UK Limited.

Ancona® - Finishes & Options

Ancona® Bare Metal Lacquer finishes pages 16-17

This industrial bare metal finish is hand finished so every radiator is unique. Variations in colour, welding and burnishing marks differ from one section to another and add to the idiosyncrasy of each radiator. Sections are given a clear gloss lacquer protecting the bare metal and enhancing their individuality.

We can also apply a tinted lacquer top coat to give extra design options, Copper and Brass (pictured right). See pages 136-137 for full details.



Copper Lacquer



Brass Lacquer



Vintage Green

Aged Brass

Satin Gold

Pearl Bronze

Feature Finishes pages 14-15

Painted in the UK, our Feature Finishes give a personal touch to any room. There are 6 exciting options to choose from; Vintage Green, Aged Brass, Satin Gold, Textured Anthracite, Copper and Pearl Bronze. See pages 7, 130-135 for more information.

Ancona® Bench Seat pages 26-27

A practical solution providing both seating and heating, perfect for boot rooms, utility rooms and conservatories. The Ancona bench seat comes supplied with a solid wooden top. See pages 144-145 for full range of sizes.



Ancona® Curved page 28

Fitting a curved Ancona into your bay window or around a curved wall will give a truly bespoke finish to a room. All come with welded feet as standard & are available in 188 RAL colours & 31 Special Finishes and new for this edition Bare Metal Lacquer. Use our **curved radiator builder online** or view the easy to follow Specification Instructions on our website theradiatorcompany.co.uk.

Ancona® Electric page 29

Our range of fully electric Ancona sizes provide the option to place your radiator in spaces where it is not possible or convenient to connect to the normal heating system. Available in one height (600mm) there are 7 sizes available with 3 sizes now available from stock. These radiators are filled with an oil/glycol mix and are IP24 rated. See page 147 for full range of sizes.



® Ancona is a registered trademark of IRSAP UK Limited.

Ancona® - Stock

Ancona® Stock radiators are incredibly versatile with literally hundreds of possible sizes in 2, 3 or 4 columns from 3-40 sections, in a choice of 3 mounting options (slip on welded feet, cast feet or 2 types of wall brackets) all available from stock.

Please visit our sectional radiator builder online at theradiatorcompany.co.uk.

Design

Prices from £102.42

Ancona® from stock, our stylish & timeless Ancona® Steel Multi Column is held in our UK warehouse for fast delivery.

- White RAL 9016 delivered in 48-72 hours
- Bare Metal Lacquer delivered in 48-72 hours, 2 tinted lacquers delivered in up to 2 weeks see pages 136-137
- Feature Finishes; Copper, Pearl Bronze, Textured Anthracite, Vintage Green, Satin Gold, Aged Brass delivered in up to 2 weeks
- 2, 3 & 4 column options
- 5 heights; 300mm, 500mm, 600mm, 750mm & 1800mm
- 3 mounting options; Slip-on Welded Feet, Wall Brackets & Cast Feet
- Up to 40 pre-assembled sections, nipple & gasket joined
- 10-year guarantee



White RAL 9016

Aged Brass

Copper Lacquer

Vintage Green

See our full Stocked range of over 360 sizes on pages 128-137.

Choice

Columns

Ancona® Stock radiators can be specified in either 2, 3 or 4 column depths in over 360 sizes in up to 40 sections.

Mounting Options

Ancona® Stock (excluding lacquer) can be mounted in one of 3 ways;

- Slip-on Welded Feet; for a contemporary look
- Cast Feet; for a classic look
- Wall Brackets to position your steel multi column at any height

Stock Bare Metal Lacquer radiators can be wall or floor mounted with universal brackets or slip-on welded feet. See pages 136-137 for more information.

Ancona® Towel Bars & Pegs

Made from steel and chromed, Ancona® towel bars can be added to Ancona® radiators to provide useful hanging space in kitchens or bathrooms. Available from stock in 48-72 hours see page 127.

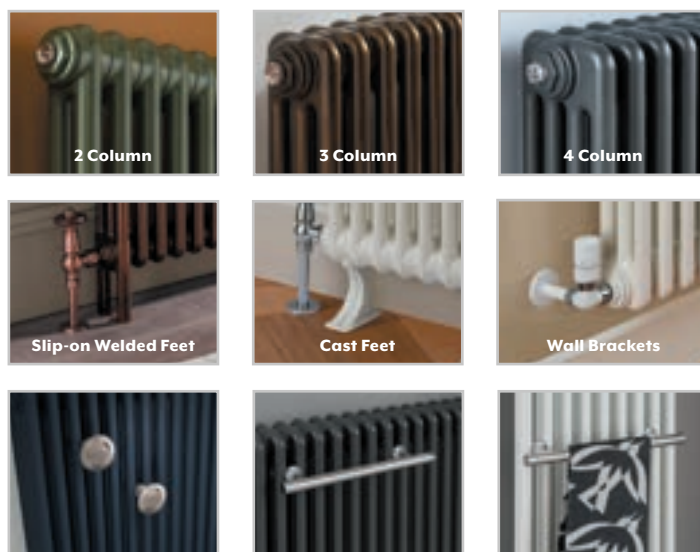

Service

All Ancona® Stock white and bare metal lacquer models are delivered in 48-72 hours. Feature Finishes: Copper, Pearl Bronze, Textured Anthracite, Vintage Green, Satin Gold and Aged Brass are available in up to 2 weeks.



Colour Coordination Service

please see page 217 for full details and how to order.

SAVE £45*

WITH OUR VALVE & PIPE COVERS PROMOTION, SEE PRODUCT PAGES AT THE BACK OF THE BROCHURE FOR FULL DETAILS. Go to our website theradiatorcompany.co.uk.

Vintage TRV & Pipe Covers



Choose from our full list of Ancona® sizes on pages 128-137 or by using our online radiator builder to select the best solution for your room. It will take you through the process quickly and easily and allows you to save your ideas to your own Wish List.

*Saving based on the value of individual items when bought separately. Order any of our selected valves and matching pipe covers at the same time as your radiator.
®Ancona is a registered trademark of IRSAP UK Limited.

Ancona[®] 2 Column

Stocked White



Colour Coordinating service

Cast Feet, 1800mm x 386mm with Chrome Vintage TRVs.

Ancona® 3 Column

Stocked White



Wall Brackets, 500mm x 836mm with Chrome Corner Ideal TRVs.

Ancona[®] 4 Column

Stocked White



Slip-on Welded Feet, 750mm x 836mm with White Ideal TRVs.

Ancona® Textured Anthracite

Feature Finishes



Copper

Textured Anthracite finish with Wall Brackets, 4 column, 600mm x 1196mm with Nickel Vintage XL TRVs.

Ancona® Vintage Green

Feature Finishes



Aged Brass

New Vintage Green finish with Slip-on Welded Feet, 2 column, 1800mm x 519mm with Black Ideal TRVs.

Ancona® 3 Column

Stocked Lacquer



With Slip-on Welded Feet, 600mm x 926mm with Nickel Vintage XL TRVs.

Ancona® 2 Column

Copper Lacquer



Brass Lacquer

With Slip-on Welded Feet, 1800mm x 341mm with Antique Copper Ideal TRVs.

Ancona® - Made to Order

Produced in our Italian factory, our made to order range of Ancona® steel multi column is the largest range in the UK, allowing maximum flexibility to create a radiator that matches your exact requirements. We offer over a vast range of Ancona Multi column in 2, 3, 4, 5 and 6 column options, with 3 different mounting options wall-hung, cast feet or welded feet.

Please visit our sectional radiator builder online at theradiatorcompany.co.uk.

Design

Prices from £29.41 per section

Ancona® Made to Order

- 2 -6 column options
- 25 heights; 195mm up to 2500mm
- 3 mounting options; Welded Feet, Cast Feet or Standard Wall Brackets
- Up to 40 sections factory welded (prices on application for 40+ sections)
- 10-Year Guarantee
- 188 RAL colours including RAL 9016 as standard plus 31 special finishes
- Up to 4 week delivery for standard white, RAL colours and special finishes
- Up to 6 weeks for bare metal lacquer (available in 300mm up to 2500mm)

See our full Made To Order range on pages 20-29.

For sizes available direct from stock please see pages 128-137.



Choice

Columns

All made to order Ancona® radiators can be specified in either 2, 3, 4, 5 or 6 column depths, allowing you to achieve the output you require in the space you have available.



Mounting Options

Our Ancona® made to order can be mounted in one of three ways: Welded Feet, Cast Feet, and Wall Brackets. Wall Brackets will allow you to position your steel multi column radiator at any height.

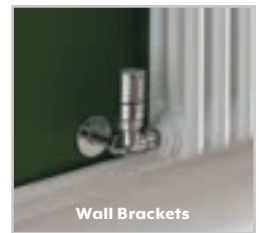
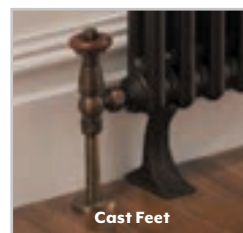

Service

Use our [online radiator builder](http://theradiatorcompany.co.uk) to select the best solution for your room. It will take you through the process quickly and easily and allows you to save your ideas to your own Wish List. [Go to our website theradiatorcompany.co.uk](http://theradiatorcompany.co.uk)

Valves

With Ancona you have a wide choice of valves to choose from, depending on your overall interior décor you could select our traditional valves, Vintage or the larger Vintage XL, available in a selection of traditional finishes. Or you might have a more modern scheme where the Ideal or Pistol range are better suited.

Save up to £45 with our valve promotion, see product pages in the back of the brochure or page 116 for full details.

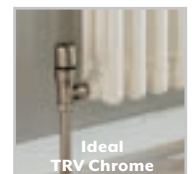
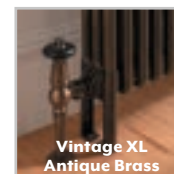
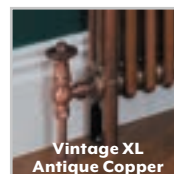

® Ancona is a registered trademark of IRSAP UK Limited.

Ancona® - Made to Order Finishes

The Ancona® made to order range is available in 188 RAL colours including our standard White RAL 9016, a bright porcelain white. We also offer 31 special finishes including Gun Metal Grey, Textured Ivory, Mottled, Metallics, Golds and a Bare Metal Lacquer finish.

Please call 01342 302250 for a RAL chart and Special Finish chart.



188 RAL Colours

Match your room style by selecting from a full rainbow of 188 RAL colours. Use either contrasting colours to create a bold statement or sympathetic colours so your Ancona® blends in to your wall.



32 Special Finishes including a Bare Metal Lacquer finish

There are 32 colours to choose from including: pastels, matts, metallics, mottled, textured effects, as well as bare metal lacquer finish.

For a Special Finish chart please call our Customer Service team on 01342 302250.

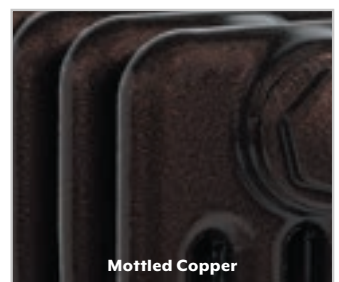
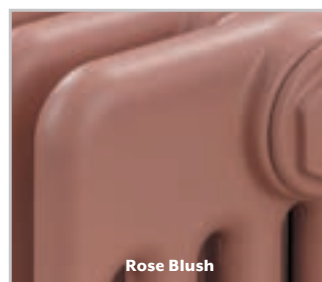
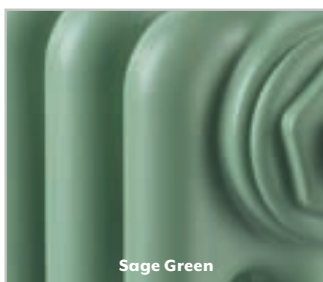

® Ancona is a registered trademark of IRSAP UK Limited.

Ancona[®] Made to Order

Welded Feet



5 column, 685mm x 476mm in new Red Oxide with Antique Brass Vintage XL TRVs



UPÉS
TISSE

3 column, 1800mm x 431mm in new Matt Ochre with matching Pistol TRVs

Ancona[®] Made to Order

Cast Feet



3 column, 1500mm x 566mm in Mottled Copper with Antique Copper Vintage TRVs.



4 column, 300mm x 881mm in Matt White with Chrome Vintage TRVs.

Ancona® Made to Order

Wall Brackets



3 column, 600mm x 701mm in Matt White with White Ideal TRVs.



2 column, 2000mm x 476mm in Carbon with Chrome Vintage XL TRVs.

Ancona[®] Bench Seat

Horizontal Made to Order



Horizontal, 6 column, 460mm x 1350mm in RAL 7047 with Wooden Top and Chrome Pistol TRVs.

Ancona® Bench Seat

Vertical Made to Order



Vertical, 5 column, 496mm x 1016mm in White RAL 9016 with Wooden Top and Nickel Vintage TRVs.

Ancona[®] Curved

Made to Order



Internal curve with Welded Feet, 4 column, 500mm x 1826mm in Mottled Copper with Antique Brass Ideal TRVS.

Ancona® Electric

Stock and Made to Order



3 Column 600mm x 843mm in White RAL 9016.

Contemporary Designer - Stock & Made to Order

Our contemporary designer range contains models that can be used throughout the home. Developed to reflect the latest trends in design these radiators will complement any interior scheme. The wide selection of sizes, formats and colour options allows you to select the perfect radiator to suit your heat output requirements, space and interior.

Knowing the heat output required (BTU/Watts) to heat your room is key when choosing your radiator. For help on calculating this and selecting the correct size of your chosen radiator please visit our website theradiatorcompany.co.uk

All Stocked Designer Radiators are now delivered in 48-72 hours.

New Technology Radiators

Smart Electric

The latest in intelligent smart heating technology is now built into a selection of our electric radiators.

Using the new NOW App it is possible to control and customise your heating straight from your smartphone.

Controlling & managing the temperature in your room has never been easier, with their precise sensors, electronic check valve & dedicated app, all fully compatible with Google Home or Amazon Alexa voice assistants.



Sax Electric



Piano Electric



Polygon

Relax Hybrid

Innovative heating and cooling combination, with a fan coil assisted radiator and cooling functions. Heats in winter and with appropriate system specification acts as a cooling unit in summer.



Relax Hybrid

Design

Prices from £315.60

As Italy's leading manufacturer with over 50 years experience of innovative design, we offer the widest choice of stylish high quality radiators with guarantees ranging from 10 to 20 years.



Choice

Aluminium

We have 4 exciting designer aluminium ranges, the Iseo, Niro, Sebino and Canto. All with the efficient features of aluminium and available in a range of sizes and colours for quick delivery. Our Low Water Content radiators are designed for improved efficiency which contribute to reduced running costs while delivering great output.



For Low Water Content radiators look out for this symbol (shown left) in the technical section.



Sebino



Niro

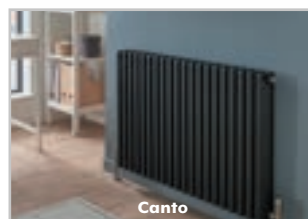

Canto



Iseo

Contemporary Designer - Stock & Made to Order

Choice

Steel

There is an extensive choice of vertical, horizontal, single & double formats, as well as a variety of tube designs so you can have the right combination of design and heat output, all available in mild steel, our designer radiators complement all types of interiors.



Service

All our designer models with stock sizes are now available for delivery in 48-72 hours. Every stock size is listed in bold in the price tables. Made to order radiators available in 4-9 weeks.

Use our **online BTU (heat output) calculator** to get a guide of your room requirements which you can then check with your installer. Once you know your outputs use our **online radiator builder** to select the best solution for your room. It will take you through the process quickly and easily and allows you to save your ideas to your own Wish List. **Please visit our website theradiatorcompany.co.uk**

Painted Valves

You have the option to fully coordinate your designer radiator colour with your valves & pipe covers to create a unique & individual statement. Note: valves & pipe covers must be ordered at the same time as the radiator. See page 117 for full details.



Pistol TRV in Azurite with matching Pipe Covers & Shrouds

Accessories

Make the most of your radiator by adding a towel bar or hanging peg. Great for kitchens, bathrooms and hallways these accessories can bring extra functionality to any radiator. See page 126-127 for full details.



Ideal TRV & Pipe Covers

SAVE £45*

WHEN YOU BUY OUR IDEAL TRV & PIPE COVERS WITH ANY DESIGNER PURCHASE. QUOTE **PROMOVI** AT TIME OF ORDER. White or Chrome only, see product pages at the back of the brochure for full details.

*Saving based on the value of individual items when bought separately.

Order any of our selected valves & matching pipe covers at the same time as your radiator; PROMOVIW (white), PROMOVIC (chrome).

Finishes

Feature Finishes (available on selected stock lines)

Painted in the UK, these 6 new Feature Finishes give a personal touch to any room. See page 7 for more details or call customer services 01342 302250 for colour swatches.

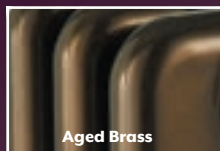

Aged Brass



Vintage Green

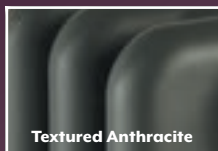

Textured Anthracite

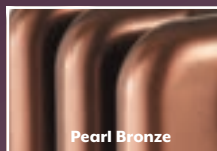

Pearl Bronze

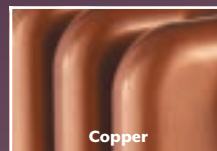

Copper



Satin Gold



Colour Coordination Service

For selected stock ranges, products that are available for this service will have the Colour Coordination icon (shown left) on their individual technical pages. **Please see page 217 for full details and how to order.**



188 RAL Colours (made to order)

Match your room style by selecting from a full rainbow of 188 RAL colours. Use either contrasting colours to create a bold statement or sympathetic colours so your designer radiator blends into your wall. **For a RAL chart please call 01342 302250.**

31 Special Finishes (made to order)

A choice of pastels, matts, metallics, mottled & textured effects. **For a Special Finish chart please call our Customer Service team on 01342 302250.**

Relax Hybrid New

Heats & Cools with Fan Assisted Technology



Horizontal with LED 650mm x 1120mm in Grey Sparkle

Polygon New

Smart Heating



Vertical 1800mm x 500mm shown in two-tone option Carbon & Grey Sparkle

Piano Electric New

Smart Heating



Hung vertically 1800mm x 443mm in White RAL 9016

Sax Electric **New**

Smart Heating

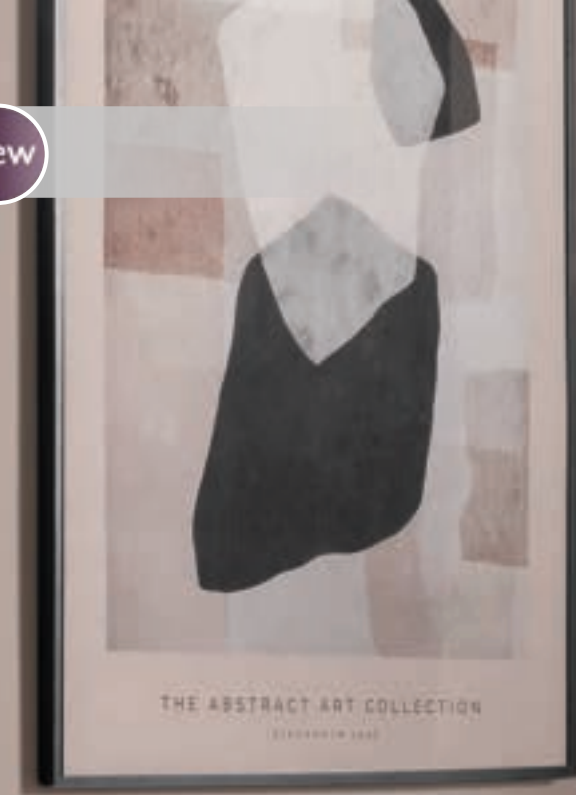

Hung horizontally 575mm x 900mm in White RAL 9016

Ceramica Collection

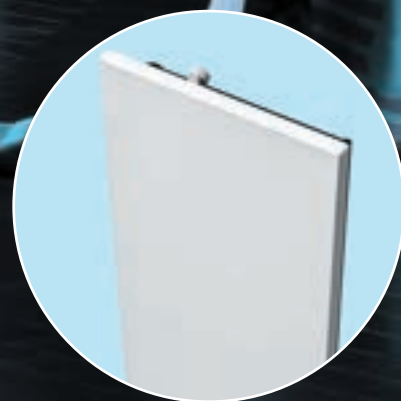
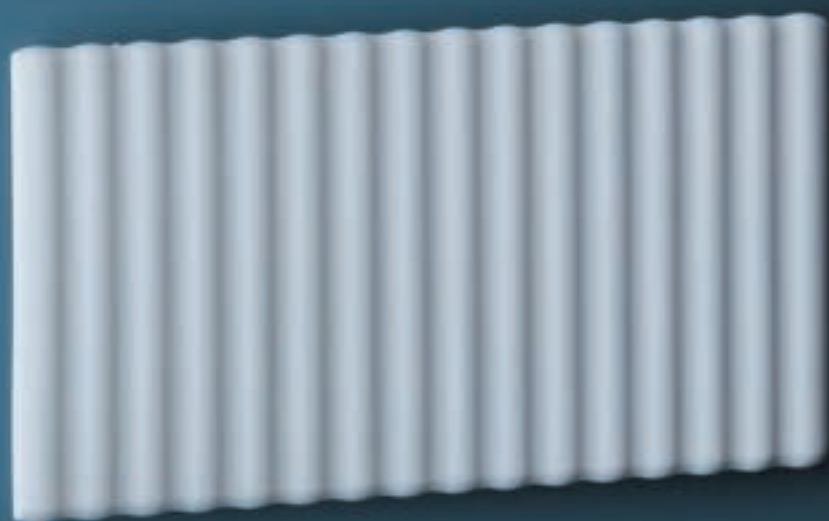

Senso Model

Varenna Model 550mm x 1100mm with integrated valves.



Pavia Model 1800mm x 300mm with integrated valves.

Torré



Horizontal 600mm x 956mm in Textured Matt White with White Ideal TRVs.

New
Colours



Vertical 1800mm x 356mm in special finish Grey Aluminium with Chrome Corner Ideal TRVs.

Niro



Horizontal 631mm x 799mm in Textured Matt White with White Corner Ideal TRVs.

New
Colours



Vertical 1831mm x 479mm in RAL 7016 with Nickel Ideal TRVs.

Iseo



Horizontal 500mm x 1185mm in Textured Matt White with White Ideal TRVs.

New
Colours



Vertical 1800mm x 335mm in RAL 7016 with matching painted Pistol TRVs.

Sebino



Horizontal 634mm x 980mm in White RAL 9010 with matching Pistol TRVs.



Mat Silver finish

Vertical 1834mm x 500mm in White RAL 9010 with White Corner Ideal TRVs.

Canto

New
Colours



668mm x 1020mm in RAL 7016 shown with Nickel Ideal TRVs.

Water Lily

New
Colours



Single 2020mm x 312mm in Matt Black with Nickel Corner Ideal TRVs.

Piano



Piano Electric shown on page 34

Double horizontal 456mm x 1220mm in Black Sparkle with Chrome Corner Ideal TRVs.

New
Colours



Double vertical 1820mm x 456mm in White RAL 9016 with Ideal TRVs.

Athena



Horizontal 410mm x 1200mm in RAL 8019 with Nickel Corner Ideal TRVs.

New
Colours



Vertical 1800mm x 410mm in White RAL 9016 with White Corner Ideal TRVs.

Relax



Double horizontal 578mm x 1401mm shown in RAL 7035 with Nickel Corner Ideal TRVs.

New
Colours



Inox single vertical

Single vertical 1853mm x 381mm in White RAL 9016 with White Corner Ideal TRVs.

Ellipsis



Single horizontal 600mm x 1020mm in Textured Anthracite with matching Pistol TRVs.

New
Colours



Double vertical

Single vertical 1820mm x 480mm shown in White RAL 9016 with Chrome Ideal TRVs.

Sitar



Double horizontal 504mm x 920mm in new Powder Blue with matching Pistol TRVs.

New
Colours



Single horizontal

Double vertical 1820mm x 402mm shown in Platinum with Nickel Ideal TRVs.

Sax

New
Colours



Double horizontal 520mm x 900mm shown in RAL 9016 with White Ideal TRVs.

New
Sizes



Sax Electric shown on page 35

Double vertical 1800mm x 400mm shown in White Aluminium with Chrome Pistol TRVs.

Halo



Horizontal 133 diameter x 2000 in Matt Black RAL 9005.



Vertical 1800mm x 155mm diameter, shown in Metallic Silver with Pistol TRVs.

Sectional Aluminium - Stock

Smooth, clean lines and slim profiles make these ranges perfect for both new homes and as replacement radiators. Their practical functionality makes them suitable for living rooms, bedrooms, or studies and our variety of accessories can also enhance their use in kitchens, bathrooms, and hallways.

Use our online radiator builder to help select the best configuration for your room; theradiatorcompany.co.uk.

Sectional Aluminium is available in:

- White RAL 9010 in 48-72 hours
- 23 RALs, 31 Special Finishes and 6 feature finishes available in up to 2 weeks

Design

Prices from £251.28

Energy Efficient & Made from Recycled Materials



Low water content

- An aluminium radiator will heat up in just over half the time of a steel radiator and use 50% less water, saving money by using less fuel. This makes aluminium among the **most energy-efficient radiators available**.
- As aluminium radiators are a third lighter than steel radiators, it means they are extremely light and easy to install on any type of wall.
- Aluminium radiators are excellent heat conductors; our products have high thermal efficiency and contain a lower amount of water, therefore heating up faster than those produced with other materials. They are therefore easier to control & cost much less to run.

With modern building methods and regulations requiring more insulation and higher U values for windows, having a more efficient heating system that can react quickly to changes in temperature and that can produce enough heat from smaller heat emitters means a more comfortable living environment and cheaper utility bills.

All of our Sectional Aluminium radiators are made in Italy and are available in 4 different profiles.



Choice

Our Sectional Aluminium ranges boast incredible versatility with hundreds of possible size options all available from stock. Meet your size requirements with 3 to 20 sections, finished in a choice of 23 RAL colours (**shown on page 216**) and 31 Special Finishes (**shown right**). See our online radiator builder for more information; theradiatorcompany.co.uk.

Sectional Aluminium - Stock

Service

White models available from stock in 48-72 hours delivery. 23 RAL colours, 31 Special Finishes and 6 feature finishes available in up to 2 weeks. (Please allow an extra 2 working days for orders of more than 10 radiators).

Use our online BTU (heat output) calculator to get a guide of your room requirements which you can then check with your installer. Once you know your outputs use our online radiator builder to select the best solution for your room. It will take you through the process quickly and easily and allows you to save your ideas to your own Wish List. **Please visit our website theradiatorcompany.co.uk**

See our stock assembled options for sizes from 3-40 sections, larger sizes will be priced on application, please call 01342 302250 for details. Please note; delivery lead times on coloured aluminium start from when we have receipt of your chosen RAL colour number and description in writing. Please ensure the selected RAL colour number and name is included on your order to avoid potential delays.

Painted Valves

You now have the option to fully coordinate your aluminium radiator colour with your valves and pipe covers to create a unique and individual statement. Image right is a Mix in Azurite with matching Pistol TRV, pipe covers & shrouds. Note: valves & pipe covers must be ordered at the same time as the radiator. **See page 117 for full details.**



Aluminium Accessories

Aluminium accessories include hanging pegs, towel bars and for the Oscar and Vip, end panels to create a clean side profile, **see page 175 for more details.**



SAVE £45*

WHEN YOU BUY OUR IDEAL TRV & PIPE COVERS WITH ANY ALUMINIUM PURCHASE. QUOTE **PROMOVI AT TIME OF ORDER.** White or Chrome only, see product pages in the back of the brochure for full details.

*Saving based on the value of individual items when bought separately.

Order any of our selected valves & matching pipe covers at the same time as your radiator; PROMOVIW (white), PROMOVIC (chrome).

White RAL 9010 delivered in 48-72 hours

Feature Finishes

Painted in the UK, our 6 Feature Finishes give a personal touch to any room, choose from Vintage Green, Satin Gold, Aged Brass, Textured Anthracite, Copper and Pearl Bronze. See page 7 for more information or call customer services for sample swatches.

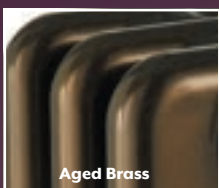

Aged Brass



Vintage Green

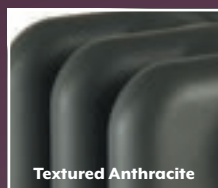

Textured Anthracite

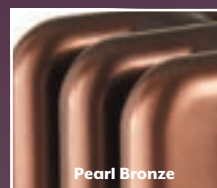

Pearl Bronze

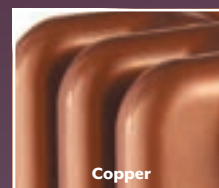

Copper



Satin Gold



23 RAL Colours

All our Sectional Aluminium radiators are available in a selection of the 23 most popular colours from the RAL range (shades of White, Cream, Grey, Brown, Red & Black), on page 216. Available in up to 2 weeks. **Please call 01342 302250 for a RAL chart.**



Colour Coordinating Service

Available for all sectional aluminium, **see product pages 217** for full details including process & lead times.

Special Finish Options

Our aluminium ranges are also available in 31 exclusive special finishes (some of which are shown below), combining the efficiency of aluminium with a truly stunning finish. Available in up to 2 weeks. **Please call 01342 302250 for a Special Finish chart.**

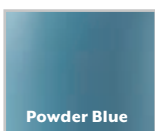

Powder Blue

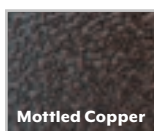

Mottled Copper

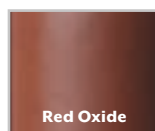

Red Oxide

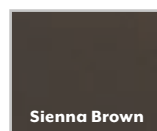

Sienna Brown



Matt Beige

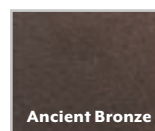

Ancient Bronze



Matt Ochre



Gun Metal Grey

For orders of more than 10 radiators in colour or special finishes please allow an extra 10 working days for delivery.

Vip



590mm x 1060mm in White RAL 9010 shown with White Pistol TRVs.



590mm x 740mm in Vintage Green shown with matching Pistol TRVs

Oscar



1646mm x 420mm colour coordinated in Dulux Natural Slate shown with optional matching end panels and matching Pistol TRVs.



1846mm x 340mm in White RAL 9010 shown with White Ideal TRVs.

Vox



440mm x 740mm in Aged Brass with Antique Brass Ideal TRVs.



1846mm x 340mm in White Aluminium with Nickel Corner Ideal TRVs.

Mix



440mm x 1060mm in Azurite with Nickel Corner Ideal TRVs.



690mm x 1060mm in White RAL 9010 with White Pistol TRVs.

Traditional Cast Iron

The epitome of traditional heating, cast iron radiators are a must for any period restoration; suitable for living rooms, bedrooms, kitchens, hallways and dining rooms. Our choice of seven classic designs offer the clean simplicity of “column” or the “decorative classic”. These radiators will be a perfect match for any existing radiators and being new, they come with a minimum ten year guarantee.

Design

Prices from £64.19 per section

As a material, cast iron has its own unique properties; these radiators will hold their heat for a long time, compared to a similar steel model, although they are slower to heat up and therefore less responsive to sudden changes in temperature.

Column

Probably the most well-known form of cast iron radiators, the original column models bring a real charm and character to any period property.



Decorative Classic

The intricate and detailed designs of the Henley and Wentworth with their tasteful scrollwork, bring a touch of splendour to your home. Our Linton range reflects the style of the 1920s, with smooth clean lines and a choice of exclusive galvanised and painted finishes.

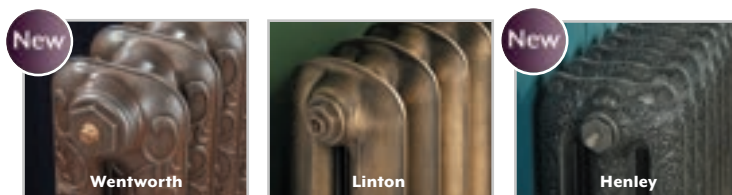

Choice

Sectional

Our sectional cast iron range is incredibly versatile with literally hundreds of possible sizes from a wide range of column depths & heights finished to your size. Use our online radiator builder to select the best solution for your room on our website theradiatorcompany.co.uk.

Mounting Options

Cast iron radiators are very heavy and therefore best mounted with floor supports. All of our ranges are available with Footed Ends as standard. The Clifton, Ledbury, Henley and Wentworth can be sold with optional Cast Feet in either an Open or Closed style, see page 189 for details.

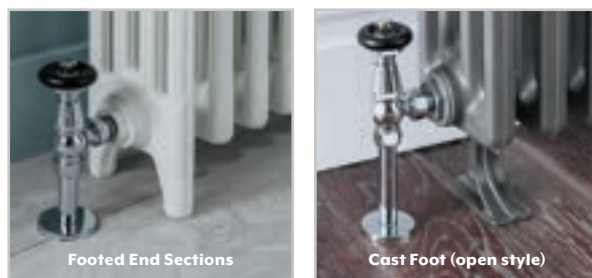

Solid Brass Wall Ties & Airvents

Available to buy with all of our cast iron radiators, see page 189 for details.



Service

Use our online radiator builder to select the best solution for your room. It will take you through the process quickly and easily and allows you to save your ideas to your own Wish List. Please visit our website theradiatorcompany.co.uk

Our range of valves include the classically styled Vintage TRV, Vintage XL TRV as well as the Black & Brass TRVs.



SAVE £45*

WHEN YOU BUY OUR VINTAGE TRV & PIPE COVERS WITH ANY CAST IRON PURCHASE. QUOTE **PROMOV2** AT TIME OF ORDER. For all Vintage TRV finishes, please see product pages in the back of the brochure for full details.

*Saving based on the value of individual items when bought separately.
Order any of our selected valves & matching pipe covers at the same time as your radiator.

Cast Iron Finishes

Our range of Cast Iron radiators are available in a wide choice of finishes. We offer a choice of colour ranges and levels of finishing for you to select from. We use high quality wet paint to finish all of our Cast Iron radiators apart from polished finishes that use a lacquer. Please note; that as a result of the casting process, cast iron radiators have a rough surface finish with small imperfections which will show after the painting process.



RAL Colours

Our Cast Iron designs are available in a large selection of RAL colours, 188 internationally recognised paint colours. Colour can add an extra element of individual style and design, creating a personal and unique result, you can select from a wide range of colours. For a RAL chart please call **01342 302250**.

Primer Finish

On selected cast iron models our standard finish is black primer, which requires finishing to prevent rust from forming. If carried out by hand this can be a long and difficult process as cast iron is very heavy and the entire surface must be covered with an appropriate undercoat and topcoats for full protection.



Classic Cast Iron Colours

We have a new range of classic cast iron colours on a selection of our cast iron models, these specially selected colours reflect the heritage and traditions of cast iron from Victorian times to the modern day.

Chosen with an eye on classic interiors these tough hard wearing and washable finishes add a stunning metallic look to your cast iron radiators.

Our selection of darker colours such as Iron Ore, Lead Grey and Factory Black are amongst the most popular choices along with the deep dark bronze of Vintage Coin and Classic Bronze.

The range of Gold's and Copper are perfect for a more rich and bold statement. For samples of our Classic Cast Iron colours please call **01342 302250**.

We are able to offer our Ledbury, Clifton, Henley and Wentworth in any one of Farrow & Ball's® or Little Greene's® stunning range of quality paints, a perfect match for any heritage property. Please see page 187 for more information.

Industrial & Burnished Finishes

A selection of our cast iron ranges are available in a beautiful, burnished finish. Created by hand in the UK, this process involves multiple stages; first a complete coat of black paint is applied to protect hidden, hard to access areas of the radiator and to provide a highlight for the visible polished areas. Then we polish the front, sides & tops of the sections, whilst the rear & more difficult to access areas between the sections (circa 2/3rds to 3/4s of the back, and the bottom) will remain black. Finally, a clear lacquer is applied to protect and maintain this exquisite finish.



Burnished on Henley **Industrial on Wentworth**



Aston Polished

Polished

Our Aston and Linton radiators are available in a beautiful high lustre, polished finish. Created by hand, an initial black paint is used to protect hidden, hard to access areas of the radiator and to highlight the visible polished areas. The front, sides and tops of the sections are polished whilst the rear and more difficult to access areas between the sections remain black. A series of burnishing & polishing processes produce the final stunning results.

Special & Galvanised Finishes

The Linton and Stamford range of cast iron models are available in 188 RAL colours, 4 special finishes exclusive to the range and a galvanised copper finish. We can also burnish both models for a unique industrial look see pages 190-191/194 for more details.

Please note, due to the printing process, these colours may not be representative of the true finished colour.



Galvanised Copper **Burnished** **Soft Gold**

Ledbury

New
Style



4 column, 360mm x 1063mm in RAL 7016 with footed end sections and Nickel Vintage TRVs.



Lead Grey finish

4 Column, 660mm x 636mm in Old Gold with Antique Brass Vintage XL TRVs.

Aston

New
Colours



3 column, 860mm x 610mm in RAL 7044 Silk Grey with Chrome Vintage XL TRVs.



Polished finish

4 column, 760mm x 493mm in White RAL 9010 with Chrome Vintage TRVs.



440mm x 1074mm shown in RAL 1013 with Chrome Vintage TRVs.



New

Burnished finish

740mm x 684mm in Classic Bronze with footed ends and Antique Brass Vintage XL TRVs.

Linton



3 Column, 621mm x 1098mm in Polished with Nickel Vintage XL TRV valves.



2 Column, 921mm x 524mm in Antique Brass with Antique Brass Vintage XL TRV valves.

Henley

New



Vintage Coin finish

470mm x 844mm in Old Gold with Antique Brass Vintage XL TRVs.



765mm x 844mm in Burnished with Nickel Vintage TRVs.

Stamford



640mm x 770mm in Burnished finish with Nickel Vintage XL TRVs.



Burnished Finish

580mm x 602mm in Industrial finish with Chrome Vintage TRVs.

Towel Rails - Stock and Made to Order

With space often at a premium, a towel rail functions as both a heat source and as a towel warmer; perfect for bathrooms, kitchens and cloakrooms.

Look out for our stocked Towel Rails delivered in 48-72 hours.

Design

Prices from £166.80

As Italy's leading manufacturer with over 50 years experience, we offer the widest choice of stylish high-quality towel rails with guarantees ranging from 10 to 20 years.

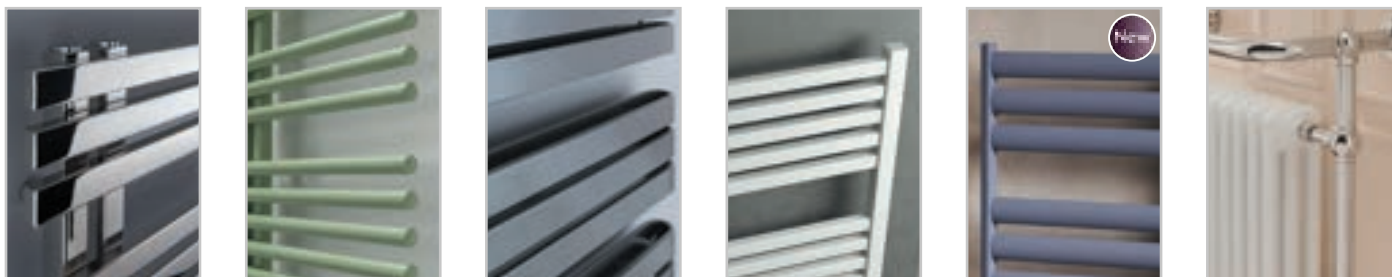

Choice

An extensive choice of styles, from standard vertical formats to horizontal and side-loading towel rails. We offer a wide variety of tube styles, including round, flat, oval, and rectangular in a range of materials; mild steel, stainless steel, and brass for the more traditional style.



Our traditional towel rails include both wall and floor mounted options, as well as a free-standing design; the Lingfield (shown far right). With distinctive period features such as ball joint connections, cast iron radiator sections and antique galvanised finishes this range provides an array of choices to complement any traditional scheme.

Service

Look out for our Towel Rails which now have stock lines available for delivery in 48-72 hours; all stock lines are shown in bold in a separate 'stock' table in the technical section pages 195-213.

Painted Valves

You have the option to fully coordinate your towel rail colour with your valves and pipe covers to create a unique and individual statement. Picture right shows a Lupin ladder rail in RAL 7016 with matching Cylinder valves and pipe covers and shrouds. **See page 117 for full details.**



Cylinder Valve & Pipe Covers

SAVE £45*

WHEN YOU BUY OUR CYLINDER VALVE & PIPE COVERS WITH ANY TOWEL RAIL PURCHASE. QUOTE PROMOV3 AT TIME OF ORDER. White or Chrome only, see product pages in the back of the brochure for full details.

*Saving based on the value of individual items when bought separately.

Order any of our selected valves & matching pipe covers at the same time as your radiator; PROMOV3W (white), PROMOV3C (chrome).

Towel Rails - Stock and Made to Order

Electric and Dual Fuel Towel Rails



New Smart Electric Piano Lato & Sitar Lato

The latest in intelligent Smart heating technology is now built into our new Piano Lato & Sitar Lato electric towel rails. Using the new NOW App it is possible to control and customise your heating straight from your smartphone. Controlling and managing the temperature in your room has never been easier, with their precise sensors, electronic check valve and dedicated app, and fully compatible with Google Home or Amazon Alexa voice assistants.

Electric Towel Rails

Fully electric self-contained units, they can be supplied with a variety of elements, some that have complete temperature and timing options built-in, some that are basic on-off options that can be controlled by an additional control panel. These stand-alone towel rails allow installation without the need for any new pipework and can be used independently of your heating system.



Purple 'electric' symbol denotes which towel rails have fully electric models.

Dual Fuel

Most towel rails are installed as part of a standard central heating system, but this means they will be cold when the heating is turned off in summer. With a dual fuel option, you can have the best of both worlds. Using a special valve connection, an electric element can be added to your towel rail to enable you to use your towel rail and keep your towels warm in the summer without having to turn on the heating.



Towel rails that can be converted will have this blue dual fuel symbol on their respective pages.



Please turn to pages 114-115 for more detailed information and prices.

Finishes

Popular stock sizes in White RAL 9016 or Chrome are available for delivery in 48-72 hours

Feature Finishes (selected stock sizes)

Painted in the UK, these 6 new Feature Finishes give a personal touch to any room. Please call customer services for colour swatches.

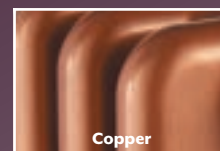
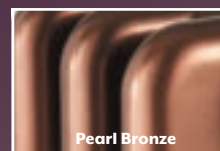
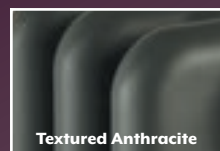
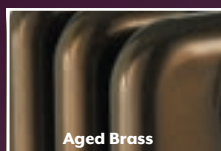

188 RAL Colours

Match your bathroom, kitchen, or cloakroom style by selecting from a full rainbow of 188 RAL colours. Use either contrasting colours to create a bold statement or sympathetic colours so your Towel Rail blends into your wall. For a RAL chart please call 01342 302250.



31 Special Finishes

A choice of pastels, matts, metallics, mottled & textured effects. For a Special Finish chart please call our Customer Service team on 01342 302250.

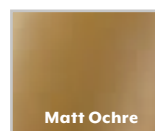
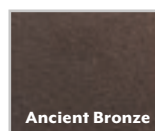
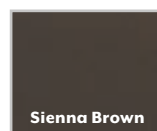
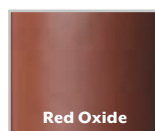
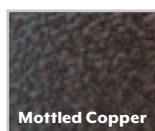
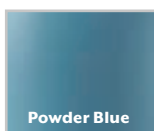

For orders of more than 10 radiators in colour or special finishes please allow an extra 10 working days for delivery.

Step BDO



BDO Step 430mm x 1500mm shown in Pearl White.



BDO Step in Chrome

Step



Step in Pearl White

Step 760mm x 500mm shown in Pearl White

Athena BDO

New
Colours



540mm x 1200mm in RAL 9016 shown with Chrome 3 Style Corner valves.

Athena Towel Rail

New
Colours



1600mm x 500mm in White RAL 9016 shown with White 3 Style Corner valves.

Relax Bagno

New
Colours



1853mm x 517mm in Polished Stainless Steel with Corner Ideal TRV valves.

Echo

New
Colours



1695mm x 600mm in White RAL 9016 with White Cylinder valves.

Piano Towel Rail

New
Colours



Single, 1156mm x 506mm in new Matt Anthracite with matching Cylinder valves.

Double in White RAL 9016 (page 199)

Piano Lato / Piano Lato Electric New



Piano Lato (page 200)



Piano Lato Electric 1176mm x 550mm in White RAL 9016.

Quadre

New
Colours



1216mm x 430mm in Matt Black with Chrome Mini Cube valves.

Pulsar



Dual Fuel options see pages 114-115.

1224mm x 500mm in Platinum with Nickel Mini Cube valves.

Ellipsis Classic New



Ellipsis Classic 1340 x 500 in White RAL 9016 with White 3 Style Corner valves.

Ellipsis Towel Rail

New
Colours



Ellipsis Towel Rail 1380mm x 400mm shown in Platinum with Nickel Ideal TRVs.

Sitar BDO / Sitar Towel Rail



Sitar BDO 543mm x 1220mm in White RAL 9016 with White 3 Style Corner valves.

Sitar Double Towel Rail (page 205)

Sitar Lato / Sitar Lato Electric New



Sitar Lato Electric (page 204)

Sitar Lato 1348mm x 500mm in Sage Green with Matching Cylinder valves.

Poll BDO



660mm x 1200mm in White RAL 9016 with White Cylinder valves.

Poll

New
Colours



Dual Fuel options see pages 114-115.

1480mm x 600mm shown in White RAL 9016 with White 3 Style Corner valves.

Poppy



Chrome option

White RAL 9016, 1497mm x 598mm with White Cylinder valves.



Satin Gold

Jet Black RAL 9005, 1497mm x 398mm with Chrome 3 Style Corner valves.

Lupin



Electric Chrome option

1210mm x 600mm in Chrome with Chrome 3 Style valves.



White RAL 9016



1210mm x 500mm in new Satin Gold with matching Cylinder valves.

Iris



Dual Fuel options see pages 114-115

600mm x 1000mm with Chrome 3 Style Corner valves.



Electric version 1200mm x 500mm.

Blues



1400mm x 500mm in Polished Stainless Steel with Chrome 3 Style valves.

Chalfont Range

Floor Standing



Wall Hung



750mm x 500mm in Chrome

Floor Standing 938mm x 675mm in Chrome.

Lingfield



850mm x 600mm in Chrome with Chrome Crosshead valves.

Linton Towel Rail



RAL colours available for cast iron sections.

900mm x 490mm with White RAL 9016 cast iron sections and Chrome Crosshead valves.

Heating Elements & Dual Fuel Kits

All available from stock and delivered in 48-72 hours.

Heating elements are used as a heat source in electric radiators, towel rails and dual fuel towel rails. You can easily install your radiator or towel rail as dual fuel by connecting it to your central heating system along with a heating element, meaning you are able to run your product as electric in the summer months.

All towel rails that can be converted to dual fuel will have a dual fuel symbol in the technical section



Follow these simple stages to select the correct Dual Fuel Kit for your towel rail.

1. Valve Configurations

All radiators will require a valve, select either a T-piece or a Dual Fuel valve to suit your installation.

2. Types of Element

There are four types of electric elements to choose from (see below and opposite).

3. How to choose your Element

It is important to select the correct size element for your towel rail. Too small and it will not provide enough heat, too large and it can burn out. The chart above right that shows the towel rail output in watts and the corresponding recommended size of element.

Towel Rail output range in Watts	Electric Elements
165 - 255	200w
260 - 375	300w
380 - 530	400w
535 - 735	600w
740 - 920	800w
920 - 1100	1000w

Round Bluetooth Element

- 5 heat settings from 30°C to 60°C regulating the internal radiator temperature, denoted by 5 LED's
- Full operational control of the element on smartphone / tablet via Bluetooth (with "Terma BLUE-Line" App: iOS / Android)
- Provides a choice of internal temperature (30°C to 60°C) or ambient room temperature (15°C to 30°C) regulation.
- 7 day timer. 2 hour drying function
- Lot 20 EcoDesign Directive compliant*
- Guarantee - 2 years
- Delivered in 48-72 hours



Black + Black Cable



Silver + Silver Cable

Description	Model	Output	IP Rating	Black Ex VAT	Black Inc VAT	Silver Ex VAT	Silver Inc VAT
Round Bluetooth Element	AARBELE	120, 200, 300, 400, 600, 800, 1000 & 1200 watts	IPx5	£190.00	£228.00	£190.00	£228.00

*Lot 20 EcoDesign Directive Compliancy - The Round & Square Bluetooth Elements (or any element fitted with the Wi-Fi Timer device) are all compliant with Lot 20; whereby an electric room radiator (does not apply to electric towel rails) has to have a weekly timer and adaptive start control/out of home control.

Low Temperature 43D Element

- Element pre-programmed to run at an internal temperature of 43°C, for Low Surface Temperature (LST) style operation*
- When specifying this element, to help ensure correct surface temperature, reduce the output of your radiator (as water) by 40% (i.e for a 200w towel rail install the 120w element)
- No Timer. 2 hour drying function
- Frost & overheating protection
- IPx5. Class 1.
- Guarantee - 2 years
- Delivered in 48-72 hours



Silver + Grey Cable

Description	Model	Output	IP Rating	Silver Ex VAT	Silver Inc VAT
Low Temperature 43D Element	LT43ELE	120, 200, 300, 400, 600 & 1000 watts	IPx5	£149.00	£178.80

*Note: Small areas of the towel rail could exceed 43° by a marginal amount during the initial heating up process

Cable Masking Cover (for Round Bluetooth & Low Temperature elements only)



Delivered in 48-72 hours

Description	Suitable for	Model	White Ex VAT	White Inc VAT	Black Ex VAT	Black Inc VAT	Silver Ex VAT	Silver Inc VAT	Chrome Ex VAT	Chrome Inc VAT
Element Masking Cover	AARBELE & LT43ELE Models	AAMASK	£10.00	£12.00	£10.00	£12.00	£10.00	£12.00	£10.00	£12.00

Heating Elements & Dual Fuel Kits

All available from stock and delivered in 48-72 hours.

Digital Square Element

- 30 Heat settings from 30°C to 60°C in steps of 1°C. Regulates the internal temperature and displays this on screen.
- Daily 24hr timer. 0.5 to 4hr drying function.
- 4x Buttons: Dryer, Power, Temp +/-.
- Frost & overheating protection.
- IPx5. Class 1. Guarantee - 2 years
- Delivered in 48-72 hours



Chrome + Grey Cable



White + White Cable

Description	Model	Output	IP Rating	White Ex VAT	White Inc VAT	Chrome Ex VAT	Chrome Inc VAT
Digital Square Element	AADSELE	120, 200, 300, 400, 600 & 1000 watts	IPx5	£172.00	£206.40	£192.00	£230.40

Square Bluetooth Element Bluetooth

- Full operational control of the element on smartphone/tablet via Bluetooth (with "Terma BLUE-Line" App: IOS/ANDROID).
- Provides a choice of internal temp (30°C to 60°C) or ambient room temp (15°C to 30°C) regulation.
- 7 day timer. 1-4hr drying function.
- Lot 20 EcoDesign Directive compliant*
- Frost & overheating protection.
- IPx5. Class 1. Guarantee - 2 years
- Delivered in 48-72 hours



Chrome + Grey Cable



White + White Cable



Black + Black Cable



Silver + Grey Cable

Description	Model	Output	IP Rating	White Ex VAT	White Inc VAT	Black / Silver Ex VAT	Black / Silver Inc VAT	Chrome Ex VAT	Chrome Inc VAT
Square Bluetooth Element	AASBELE	120, 200, 300, 400, 600, 800 & 1000 watts	IPx5	£230.00	£276.00	£241.00	£289.20	£251.00	£301.20

Corner TRV Valve for Dual Fuel

- This valve is ideal for dual fuel as it incorporates a TRV, Lockshield with an integrated T Piece, to accommodate the element.
- Valve colour: Chrome
- Delivered in 48-72 hours



Image shows left hand option

Description	Model	Chrome Ex VAT	Chrome Inc VAT
Dual Fuel TRV Valve - Right Hand	VVDFTRVRH	£244.00	£292.80
Dual Fuel TRV Valve - Left Hand	VVDFTRVLH		

T-Piece (for Dual Fuel)

- A T Piece is required for Dual Fuel installation as it allows both an element and a valve to be fitted to the same tapping on a radiator.
- We offer one type of valve where no T Piece is required (detailed above). Or you can source your own standard pair of valves to fit along with this T Piece.
- Delivered in 48-72 hours



White



Chrome



Matt Black



Matt Silver

Description	Model	Price Ex VAT	Price Inc VAT
White T-Piece (for Dual Fuel)	AATPIECEW	£13.00	£15.60
Matt Black T-Piece (for Dual Fuel)	AATPIECEB	£13.00	£15.60
Matt Silver T-Piece (for Dual Fuel)	AATPIECES	£13.00	£15.60
Chrome T-Piece (for Dual Fuel)	AATPIECEC	£16.00	£19.20

Fused Spur with Programmer

- Combination fused spur & 7 day timer in one. Fully controllable from anywhere in the world via free app (ANDROID & IOS).
- 40mm projection. Fits over standard flush or surface mount back box - 32mm deep.
- 3kw load capacity.
- Non IP Rated - install outside bathroom.



Description	Model	Price Ex VAT	Price Inc VAT
Fused Spur and Wifi Timer Combination Device	AAFSWTIMER	£174.00	£208.80

Delivered in 48-72 hours

Valves

Every Radiator needs a pair of valves to operate. Efficient performance is not the only benefit of good quality valves, they also add to the appearance of your finished radiator. All our valves have a 5 year warranty and can be delivered within 48-72 hours.

Wheelhead and Lockshield

Every Radiator requires a pair of valves that work together, the Wheelhead adjusts the flow of water into the radiator and the Lockshield balances the flow of water around the whole system, ensuring each radiator heats up at the same rate, these should be adjusted by your installer.

TRV or Manual?

Thermostatic Radiator Valves (TRVs) monitor the room temperature. They usually have between 4 to 6 levels and the valve opens and closes automatically to reach and maintain the desired level. TRVs can help maximise the efficiency of your system reducing energy consumption and are now a requirement as part of building regulations relating to new builds and refurbishments.

Manual valves are adjusted by hand; they allow a constant flow of water through your radiator regardless of the room temperature and radiators will only turn off when the main thermostat reaches its set point or the programmer turns the heating off.

Angled, Corner or Straight?



Angled from floor



Corner from wall

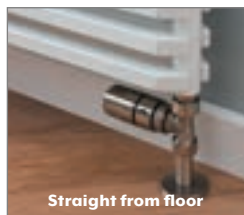

Straight from floor

Pipework and Pipe centres

All our valves have 15mm connections as standard unless otherwise stated; if you need different connections please specify when ordering your valves. The use of plastic pipe has become more popular; however, our valves are not designed to operate with plastic pipes. Also, if chrome pipework is used most valves will not grip it securely because chrome is a harder surface than copper or iron and leaks can occur. Special fittings are required to enable valves to grip chrome pipe work and these must be specified at time of order. The position of the pipework for your radiator will be affected by the valves you select. All angled valves have a dimension to allow for adjusting pipe work. You should make adequate allowances for manufacturing tolerances in pipe centres. For straight valves, a minimum of 150mm should be allowed from the base of the radiator for ease of installation.

Please note: We will always supply angled valves as standard, if you require straight please specify at time of order. We endeavour to ensure all pipe centres are correct, however manufacturing tolerances must be considered; we strongly recommend that pipe work is not altered or adjusted until the new radiator or towel rail is fitted. The Radiator Company will not accept any responsibility for claims resulting from incorrect pipe centres.

SAVE £45*

WHEN YOU BUY OUR SELECTED VALVES AND MATCHING PIPE COVERS WITH ANY RADIATOR OR TOWEL RAIL ORDER.

Saving based on the value of individual items when bought separately. Order any of our selected valves & matching pipe covers at the same time as your radiator quoting the relevant promo code below. See individual product pages for details.

IDEAL TRV (white / chrome)



Please quote **PROMOV1**
(specifying 'W' for white or 'C' chrome)

VINTAGE TRV (any finish)



Please quote **PROMOV2**
(please specify your finish at time of order)

CYLINDER VALVE (white / chrome)



Please quote **PROMOV3**
(specifying 'W' for white or 'C' chrome)

Painted Valves

Create a unique and individual statement with your valves and pipe covers. The valves pictured below can be painted in the same colour as your radiator from one of our 23 RAL colours shown on page 216, 31 Special Finishes and 6 new Feature Finishes.

Pictured right is a Vip in Vintage Green with matching painted Pistol TRVs, pipe covers & shrouds. Painted valves are delivered in up to 2 weeks.

Please note: Painted valves & pipe covers can only be ordered in the same colour and at the same time you order your painted radiator and can not be purchased separately.



To provide complete coordination, simply follow these three easy steps:

1. Select your valve



Pistol TRV
(shown in Azurite)

Description	Model	Colour Ex VAT	Colour Inc VAT
DELIVERY TIMES		UP TO 2 WEEKS	
Angled or Straight	VVPISTRV	£307.00	£368.40



Cylinder
(shown in RAL 7016)

Description	Model	Colour Ex VAT	Colour Inc VAT
DELIVERY TIMES		UP TO 2 WEEKS	
Angled or Straight	VVCYL	£213.00	£255.60



Crosshead
(shown in Mottled Copper)

Description	Model	Colour Ex VAT	Colour Inc VAT
DELIVERY TIMES		UP TO 2 WEEKS	
Angled or Straight	VVCRO	£302.00	£362.40

2. Select your colour from a choice of 23 RALs, 31 Special Finishes and 6 new Feature Finishes

There are 23 RAL colours and 31 Special Finishes to choose from including pastels, matts, metallics, mottled and textured effects and 6 feature finishes shown below. For a RAL or Special Finish chart please call our Customer Service team on 01342 302250.

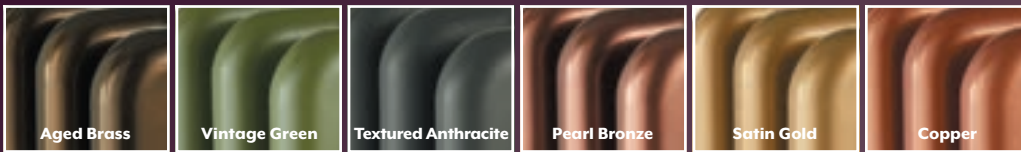
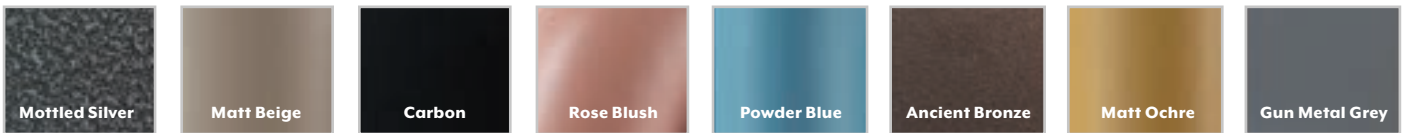

Feature Finishes

Available when purchasing products painted in Feature Finishes only. Please call customer services for sample swatches.

Please note: we are unable to match valves to any lacquer finishes

3. Select matching pipe covers and shrouds

We can also match the colour of the pipe covers and pipe shrouds for your radiators or towel rails in any one of the colour options shown above. Each pair of painted pipe covers comes with matching shrouds.



Azurite



Mottled Copper



Textured Black Matt



Platinum



RAL 7016

Description	Model	Colour Ex VAT	Colour Inc VAT
DELIVERY TIMES		UP TO 2 WEEKS	
Pipe Covers (Pair)	AAPIPECOVR	£145.00	£174.00

Each set is supplied with 2 x 160mm pipe covers & 2 shrouds. Delivery on coloured pipe covers is up to 2 weeks.

NOW Smart Heating System New

NOW is a cutting-edge system for smart, wireless and multi-zone heating for any type of home: from apartments, to lofts and houses. The intelligent thermostats, smart thermostatic valve heads, and independent electric products that make up the system can be controlled remotely through a simple, intuitive app that works with Android and iOS or via voice assistants such as Google Home or Alexa. NOW is compatible with all radiator brands and with the major valve manufacturers, it is designed to improve your comfort, control air temperature and quality, reduce the impact of heating on the environment, and save energy consumption by optimising performance.

- Control all your home heating in one place, wherever you are!
- Smart Scheduling; Reduced energy consumption. The system learns from your habits and automatically adapts to guarantee maximum comfort, and minimise energy use.
- Component based system from stand-alone products, retrofit smart TRV head to or complete packages that encompass your hot water and heating, room thermostats and boiler/heat pump management.
- Home/away; NOW System recognises your movements and adapts your heating to reflect when you are away from home.
- Air Quality; Smart Thermostats can monitor the quality and humidity levels in the room.
- Works with Alexa and Google Home.
- Download the App for free from the App Store or Play Store and install it on any smartphone with an Android or iOS operating system.



For full details & information on how to configure your Smart Heating System please visit our dedicated webpage

Smart Valve



With NOW Smart TRVs you control the temperature intelligently from wherever and whenever you want via your smartphone. The wireless thermostatic valve heads are compatible with all radiator brands and leading hydraulic valve manufacturers. The LED will change colour according to the set temperature, for example Green indicates 18°C-20°C, Blue 12°C-15°C, Red 25°C-32°C.



Description	Model	Price Ex VAT	Price Inc VAT
SMART VALVE	2ISMARTVALV01	£114.00	£136.80

Delivered in 48-72 hours

Coloured Smart Valves

Smart Valves are available in different colours to match perfectly to your radiator and the style of your home, please visit www.theradiatorcompany.co.uk/now-smart-heating for a full list of colour options. Coloured valves are available in up to 4 weeks.



Sage Green



Matt Beige



Sienna Brown



Powder Blue



Titanium Grey



Blue Lilac (RAL 4005)



Sunstone



Black Blue (RAL 5004)



Rose Blush



Moss Green (RAL 6005)

Description	Model	Price Ex VAT	Price Inc VAT
COLOURED SMART VALVE	2ISMARTVALVXX	£144.00	£172.80

Please specify colour at time of order, delivered in up to 4 weeks.



Matt White set to 20°C

Smart Thermostat Kit

The NOW smart thermostat kit is ideal way to start experiencing the benefits of smart heating. The Smart Thermostat allows you to easily to set and accurately measure the temperature, humidity level and air quality inside your home. The Connection Unit connects to your home router and is essential for using the Smart Thermostat wherever and whenever you want directly from your smartphone. Smart Thermostat Kits are delivered in 48-72 hours.

Description	Model	Price Ex VAT	Price Inc VAT
SMART THERMOSTAT KIT 1	2IKITSTART1	£285.00	£342.00

Kit includes; 1x Connection Unit & Repeater, 1x Smart Thermostat, 2x AA Batteries
1x Wall plate, 2x Wall fixing screws, 2x Wall plugs, 1x Ethernet cable, 1x USB Cable



Smart Valve Kit



The IRSAP NOW smart valve kit is ideal to start experiencing home comfort with smart heating. With IRSAP NOW Smart Valves you control the temperature from wherever and whenever you want via smartphone. Our wireless thermostatic valves are compatible with all radiator brands and leading hydraulic valve manufacturers. The Connection Unit is connected to your home router and is indispensable for controlling Smart Valves wherever and whenever you want directly from your smartphone. Smart Valve Kits are delivered in 48-72 hours.

Description	Model	Price Ex VAT	Price Inc VAT
SMART VALVE KIT 2	2IKITSTART2	£309.00	£370.80

Kit includes; 1 Connection Unit, 2 Smart Valves, 1 Ethernet cable, 1 USB cable,
2 Power plugs (EU, UK), 4 AA batteries, 12 Valve Adaptors



Please visit www.theradiatorcompany.co.uk/nov-smart-heating to view our dedicated Smart Heating page



Connection Unit & Repeater

The Connection Unit is connected to the home router and is essential for controlling all the other devices in the NOW system wherever and whenever you want; directly from your smartphone via the NOW App. Connection Units and Repeaters are delivered in 48-72 hours.

Description	Model	Price Ex VAT	Price Inc VAT
CONNECTION UNIT & REPEATER	2IHUBNOW2	£189.00	£226.80

Smart Thermostat

Replace your traditional thermostat with our Smart Thermostat with advanced functions for precise room temperature control, and air quality monitoring (checking levels of humidity, Carbon Monoxide etc). Smart Thermostats are delivered in 48-72 hours.

Description	Model	Price Ex VAT	Price Inc VAT
SMART THERMOSTAT	2ISMARTTHERMO	£185.00	£222.00



Starter (NOW Boiler Module)

Get the most out of your heating system with the NOW modulating boiler and heat pump starter, which will allow you to optimise the use and activation of your boiler or other heat generator.

If your heat generator is designed for power modulation (the functionality to 'turn down' its output. For example if you have a 20kw boiler, but only need 10kw of heat, instead of repeatedly outputting 20kw for 5 minutes then resting for 5 minutes, which is how non-modulating boilers work, the boiler will simply turn down its flame by 50%) the NOW Starter can optimize its efficiency, reducing boiler ignitions, reducing consumption. Starters are delivered in 48-72 hours.

Description	Model	Price Ex VAT	Price Inc VAT
STARTER	2IHEATSTARTER	£189.00	£226.80

TRV Valves

Stocked valves are listed in bold & will be delivered in 48-72 hours.

Corner Ideal TRV shown on pages 12, 39, 48 & 53

Available in six finishes
Delivered in 48-72 hours.



Chrome Corner Ideal TRV on Anconda*



Chrome Wheelhead & Lockshield

Pipe Centers For corner valves allow an extra 90mm in total	Valve Height 116mm	Please Note Corner Ideal TRV valves are not bi-directional
---	------------------------------	--



Antique Brass



White



Black



Nickel



Antique Copper

Description	Model	Chrome Ex VAT	Chrome Inc VAT	White Ex VAT	White Inc VAT	Nickel Ex VAT	Nickel Inc VAT	Black Ex VAT	Black Inc VAT	Antique Copper Ex VAT	Antique Copper Inc VAT	Antique Brass Ex VAT	Antique Brass Inc VAT
Corner only	VVCOIDTRV	£173.00	£207.60	£173.00	£207.60	£242.00	£290.40	£242.00	£290.40	£242.00	£290.40	£242.00	£290.40

TRV Valves

Stocked valves are listed in bold & will be delivered in 48-72 hours.

Ideal TRV shown on pages 15, 38, 46 & 55.

Available in six finishes, in angled or straight options, the Ideal TRV is a great value Thermostatic valve. Delivered in 48-72 hours.



Nickel Angled Ideal TRV on Ancona*



Nickel

Pipe Centers For angled valves allow an extra 80mm in total	Valve Height 125mm	Please Note Ideal TRV valves are not bi-directional
--	-----------------------	--



Chrome



Antique Brass



Antique Copper



Black



White

Please note:

All valves are sold in pairs, a lockshield and a wheelhead. Angled will be supplied as standard, please specify if you require straight valves.

Description	Model	Chrome Ex VAT	Chrome Inc VAT	White Ex VAT	White Inc VAT	Nickel Ex VAT	Nickel Inc VAT	Black Ex VAT	Black Inc VAT	Antique Copper Ex VAT	Antique Copper Inc VAT	Antique Brass Ex VAT	Antique Brass Inc VAT
Angled or straight	VVIDETRV	£166.00	£199.20	£166.00	£199.20	£205.00	£246.00	£205.00	£246.00	£205.00	£246.00	£205.00	£246.00

Ideal TRV Kits

Ideal TRV Kit consists of valves, pipe covers and shrouds, saving up to £25.00 compared to when bought separately.



Description	Model	Chrome Ex VAT	Chrome Inc VAT	White Ex VAT	White Inc VAT	Nickel Ex VAT	Nickel Inc VAT	Black Ex VAT	Black Inc VAT	Antique Copper Ex VAT	Antique Copper Inc VAT	Antique Brass Ex VAT	Antique Brass Inc VAT
Valve, Cover and Shroud Kit	VVIDETRVKIT	£198.00	£237.60	£198.00	£237.60	£238.00	£285.60	£238.00	£285.60	£238.00	£285.60	£238.00	£285.60

Traditional Valves

Stocked valves are listed in bold & will be delivered in 48-72 hours.

Vintage TRV shown on pages 11, 23, 74 & 77

The Vintage TRV valve offers great value.

- Made from die-cast brass
- Best suited to 2, 3, & 4 column Ancona's®
- Height 115mm
- Weight 460g
- Available from stock in 48-72 hours
- Made in Italy

Pipe Centers For angled valves allow an extra 90mm in total	Valve Height 115mm	Please Note Vintage TRV valves are not bi-directional
--	-----------------------	--



Nickel Angled Wheelhead & Lockshield (Black Top)



Antique Copper Wheelhead (Walnut Top)



Polished Brass Wheelhead (Walnut Top)



Chrome Wheelhead (Black Top)



Antique Brass Wheelhead (Walnut Top)

Description	Model	Polished Brass Ex VAT	Polished Brass Inc VAT	Chrome Ex VAT	Chrome Inc VAT	Nickel Ex VAT	Nickel Inc VAT	Antique Brass Ex VAT	Antique Brass Inc VAT	Antique Copper Ex VAT	Antique Copper Inc VAT
Vintage TRV Angled	VVVINTRV	£192.00	£230.40	£205.00	£246.00	£276.00	£331.20	£268.00	£321.60	£268.00	£321.60
Vintage TRV Straight	VVVINTRV	£219.00	£262.80	£236.00	£283.20	£331.00	£397.20	£320.00	£384.00	£320.00	£384.00

Please note: all valves are sold in pairs, a lockshield & a wheelhead. Angled supplied as standard, please specify if you require straight valves. Straight Vintage TRV valves in Chrome are available from stock in 48-72 hours, all other finishes will be delivered in 5 weeks.

Vintage TRV Kit

Kit consists of valves, pipe covers and shrouds, save up to £30.00 when buying the Vintage TRV Kit (see page 123 for images).

Description	Model	Polished Brass Ex VAT	Polished Brass Inc VAT	Chrome Ex VAT	Chrome Inc VAT	Nickel Ex VAT	Nickel Inc VAT	Antique Brass Ex VAT	Antique Brass Inc VAT	Antique Copper Ex VAT	Antique Copper Inc VAT
Angled Valve, Cover and Shroud Kit	VVVINTRVKIT	£226.00	£271.20	£238.00	£285.60	£307.00	£368.40	£297.00	£356.40	£297.00	£356.40
Straight Valve, Cover and Shroud Kit	VVVINTRVKIT	£251.00	£301.20	£268.00	£321.60	£364.00	£436.80	£354.00	£424.80	£354.00	£424.80

Vintage TRV special corner valves

Vintage TRV valves are available in a selection of handed return angled valve options. Return angled valves are left and right-handed, you can select the correct option by identifying which side of the radiator has the flow connection; e.g flow connection on the left side requires a left-hand wheelhead and matching lockshield.

Please specify left or right-hand return for the wheelhead when ordering the return angled valves, Chrome is available from stock in 48-72 hours, delivery is 5 weeks for all other finishes. **Please call 01342 302250 for more information.**

Description	Model	Polished Brass Ex VAT	Polished Brass Inc VAT	Chrome Ex VAT	Chrome Inc VAT	Nickel Ex VAT	Nickel Inc VAT	Antique Brass Ex VAT	Antique Brass Inc VAT	Antique Copper Ex VAT	Antique Copper Inc VAT
Angled to Wall	VVVINTRV	£238.00	£285.60	£257.00	£308.40	£364.00	£436.80	£349.00	£418.80	£349.00	£418.80



Left-hand return angled valve in Chrome

Traditional Valves

Stocked valves are listed in bold & will be delivered in 48-72 hours.



Nickel Angled Wheelhead & Lockshield (Black Top)

Vintage XL TRV

shown on pages 14, 16, 79, 81 & 82.

The Vintage XL TRVs large size creates an impactful presence.

- Made from die-cast brass
- Best suited to 5 & 6 column Ancona's® and Cast Iron radiators
- Height 160mm
- Weight 881g
- Available from stock in 48-72 hours
- Made in Italy

Pipe Centers For angled valves allow an extra 120mm in total	Valve Height 160mm	Please Note Vintage XL TRV valves are not bi-directional
---	-----------------------	---



Polished Brass Wheelhead (Walnut Top)



Chrome Wheelhead (Black Top)



Antique Copper Wheelhead (Walnut Top)



Antique Brass Wheelhead (Black Top)

Description	Model	Polished Brass Ex VAT	Polished Brass Inc VAT	Chrome Ex VAT	Chrome Inc VAT	Nickel Ex VAT	Nickel Inc VAT	Antique Brass Ex VAT	Antique Brass Inc VAT	Antique Copper Ex VAT	Antique Copper Inc VAT
Angled	VVVINXLTRV	£374.00	£448.80	£391.00	£469.20	£468.00	£561.60	£468.00	£561.60	£468.00	£561.60

Please note: all valves are sold in pairs, a lockshield & a wheelhead. Angled only.

Vintage XL TRV Kit

Kit consists of valves, pipe covers and shrouds, save up to £27.00 when buying the Vintage XL TRV Kit.



Description	Model	Polished Brass Ex VAT	Polished Brass Inc VAT	Chrome Ex VAT	Chrome Inc VAT	Nickel Ex VAT	Nickel Inc VAT	Antique Brass Ex VAT	Antique Brass Inc VAT	Antique Copper Ex VAT	Antique Copper Inc VAT
Valve, Cover and Shroud Kit	VVVINXLKIT	£406.00	£487.20	£421.00	£505.20	£499.00	£598.80	£499.00	£598.80	£499.00	£598.80

Traditional Valves

Stocked valves are listed in bold & will be delivered in 48-72 hours.

Black & Brass TRV

Delivered in 48-72 hours.



Brass Angled Wheelhead & Lockshield



Brass Straight Wheelhead & Lockshield



Chrome Straight Wheelhead & Lockshield



Chrome Angled Wheelhead & Lockshield

Pipe Centers For angled valves allow an extra 80mm in total	Valve Height 127mm	Please Note Black & Brass TRV valves are not bi-directional
---	------------------------------	---

Description	Model	Brass Ex VAT	Brass Inc VAT	Chrome Ex VAT	Chrome Inc VAT
Angled or straight	VVNB&BTRV	£187.00	£224.40	£196.00	£235.20

Please note: all valves are sold in pairs, a lockshield and a wheelhead. Angled will be supplied as standard, please specify if you require straight valves.

Pistol TRV shown on pages 43, 44, 64 & 71

Available in three standard finishes as well as painted options (see page 117), the Pistol TRV is available in angled or straight configurations.

Delivered in 48-72 hours.

Pipe Centers For angled valves allow an extra 80mm in total	Valve Height 128mm	Please Note Pistol TRV valves are not bi-directional
---	------------------------------	--



Chrome Angled Wheelhead & Lockshield (shown in the fully open position)



White Angled Wheelhead



Nickel Angled Wheelhead

Standard Finishes

Description	Model	Chrome Ex VAT	Chrome Inc VAT	White Ex VAT	White Inc VAT	Nickel Ex VAT	Nickel Inc VAT
Angled or Straight	VVPISLTRV	£228.00	£273.60	£236.00	£283.20	£317.00	£380.40

Please note: all valves are sold in pairs, a lockshield and a wheelhead. Angled will be supplied as standard, please specify if you require straight valves.

Pistol TRV Kits

Pistol TRV Kit consists of valves, pipe covers and shrouds, save up to £28.00.

Description	Model	Chrome Ex VAT	Chrome Inc VAT	White Ex VAT	White Inc VAT	Nickel Ex VAT	Nickel Inc VAT
Valve, Cover and Shroud Kit	VVPISLTRVKIT	£257.00	£308.40	£268.00	£321.60	£347.00	£416.40



Manual Valves for towel rails

Stocked valves are listed in bold & will be delivered in 48-72 hours.

3 Style Corner Valve

shown on pages 90, 91, 100 & 103.



Pipe Centers For angled valves allow an extra 80mm in total	Valve Height 55mm	Please Note 3Style valves are not bi-directional
---	-----------------------------	--

Description	Model	White Ex VAT	White Inc VAT	Chrome Ex VAT	Chrome Inc VAT	Silver Ex VAT	Silver Inc VAT
Angled or straight	VV3STY	£189.00	£226.80	£164.00	£196.80	£208.00	£249.60

Please note: all valves are sold in pairs, a lockshield and a wheelhead. Angled will be supplied as standard, please specify if you require straight valves.

Mini Cube

shown on pages 96 & 97.



Pipe Centers For angled valves allow an extra 72mm in total	Valve Height 79mm	Please Note Mini Cube valves are not bi-directional
---	-----------------------------	---

Description	Model	White Ex VAT	White Inc VAT	Chrome Ex VAT	Chrome Inc VAT	Nickel Ex VAT	Nickel Inc VAT
Angled Only	VVMICUAN	£192.00	£230.40	£192.00	£230.40	£233.00	£279.60

Crosshead

shown on pages 112 & 113.



Pipe Centers For angled valves allow an extra 80mm in total	Valve Height 110mm	Please Note Crosshead valves are not bi-directional
---	------------------------------	---

Valves are sold in pairs, a lockshield and a wheelhead. Angled supplied as standard, please specify if you require straight valves.

Description	Model	Chrome Ex VAT	Chrome Inc VAT	Antique Copper Ex VAT	Antique Copper Inc VAT	Nickel Ex VAT	Nickel Inc VAT
Angled or straight	VVCRO	£193.00	£231.60	£257.00	£308.40	£302.00	£362.40

This valve can be painted in a choice of 23 RAL colours and 31 Special Finishes and 6 new Feature Finishes, see page 117

Cylinder

shown on pages 93, 102 & 104.



Pipe Centers For angled valves allow an extra 80mm in total	Valve Height 85mm	Please Note Cylinder valves are not bi-directional
---	-----------------------------	--

Valves are sold in pairs, a lockshield and a wheelhead. Angled supplied as standard, please specify if you require straight valves.

Description	Model	White Ex VAT	White Inc VAT	Chrome Ex VAT	Chrome Inc VAT	Nickel Ex VAT	Nickel Inc VAT
Angled or straight	VVCYL	£124.00	£148.80	£124.00	£148.80	£150.00	£180.00

This valve can be painted in a choice of 23 RAL colours and 31 Special Finishes and 6 new Feature Finishes, see page 117

Pipe Covers & Shrouds

Available in 7 set colours; White, Chrome, Antique Copper, Nickel, Polished Brass, Antique Brass & Black.

Pipe covers and shrouds are the perfect method of creating a neat finish for your radiators. They remove the need to paint copper pipes and hide unsightly holes drilled in the floor or wall for the feed pipe.

Available in 7 standard finishes, they can be delivered in 48-72 hours.

Each set is supplied with two 160mm covers and two shrouds.

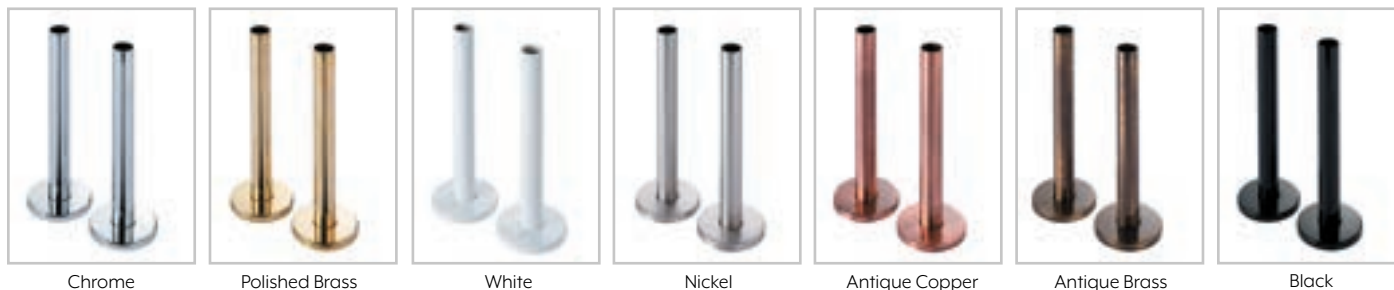

Description	Model	Chrome Ex VAT	Chrome Inc VAT	Polished Brass Ex VAT	Polished Brass Inc VAT	White Ex VAT	White Inc VAT	Nickel Ex VAT	Nickel Inc VAT	Antique Copper Ex VAT	Antique Copper Inc VAT	Antique Brass Ex VAT	Antique Brass Inc VAT	Black Ex VAT	Black Inc VAT
DELIVERY TIMES		48-72 HOURS								48-72 HOURS					
Pipe covers	AAPIPECOV	£47.00	£56.40	£47.00	£56.40	£47.00	£56.40	£54.00	£64.80	£54.00	£64.80	£54.00	£64.80	£54.00	£64.80

Save money when you buy your pipe covers and shrouds as part of a valve kit, see page 116 for more information.

Accessorise your Radiator

These towel bars are designed to fit our round-tubed designer radiators as well as selected models of our oval and rectangular tubed radiators in both single and double configurations. Ideal for providing additional hanging space in your kitchen or bathroom to air towels or hang bathrobes. Available in White, Chrome plus 188 RAL Colours & 31 Special Finishes.

White & Chrome delivered in 48-72 hours, Colours delivered in up to 3 weeks.

Towel Bars

Description	Length	Model	White Ex VAT	White Inc VAT	Colour Ex VAT	Colour Inc VAT	Chrome Ex VAT	Chrome Inc VAT
DELIVERY TIMES			48-72 HOURS		UP TO 3 WEEKS		48-72 HOURS	
Round Hanging Bar - Small	370mm	AAHB370	£99.00	£118.80	£109.00	£130.80	£183.00	£219.60
Round Hanging Bar - Large	480mm	AAHB480	£99.00	£118.80	£109.00	£130.80	£183.00	£219.60
Square Hanging Bar - Small	450mm	AAHB450	£145.00	£174.00	£160.00	£192.00	£349.00	£418.80
Square Hanging Bar - Large	550mm	AAHB550	£113.00	£135.60	£124.00	£148.80	£389.00	£466.80

Hanging Pegs

Description	Height	Model	White Ex VAT	White Inc VAT	Colour Ex VAT	Colour Inc VAT	Chrome Ex VAT	Chrome Inc VAT
DELIVERY TIMES			48-72 HOURS		UP TO 3 WEEKS		48-72 HOURS	
Square Hanging Peg	50mm	AAHPSQ50	£61.00	£73.20	£77.00	£92.40	£134.00	£160.80
Round Hanging Peg	55mm	AAHPRO55	£206.00	£247.20	£226.00	£271.20	£134.00	£160.80

A nominal £5 charge for postage & packing will be applied to any orders under £50 in value.



Ancona® Accessories

Ancona® Towel Bars & Pegs

Adapt your Ancona® for the bathroom or kitchen with a towel bar or peg.

Available from stock.

Towel Bars

Ancona's must be a minimum of 8 sections wide in order for a towel bar to fit

Description	Model	Price Ex VAT	Price Inc VAT
DELIVERY TIMES		48-72 HOURS	
To fit 8 sections or more	PPANCSTB08	£109.00	£130.80
To fit 10 sections or more	PPANCSTB10	£119.00	£142.80

Please Note: The towel bar will sit off centre for Ancona radiators that have an uneven number of sections.



Ancona® Towel Bar Chrome



Ancona® Pegs Chrome



Ancona® Towel Bar Chrome

Pegs

Description	Model	Chrome Ex VAT	Chrome Inc VAT	Colour Ex VAT	Colour Inc VAT
DELIVERY TIMES		48-72 HOURS		UP TO 3 WEEKS	
Square 50mm Peg	PPANCSSQ50	£134.00	£160.80	£77.00	£92.40
Round 55mm Peg	PPANCRO55	£134.00	£160.80	£77.00	£92.40

Optional Solid Brass Wall Ties & Airvents

These solid brass wall ties provide a stylish finishing touch to any Ancona® radiator; select to match your valves. Available as a kit including matching airvent and blanking plug in Antique Brass, Chrome and Brushed Nickel. Please note these wall ties and airvents are an optional extra and do not come as standard with your Ancona® radiator.

Description	Model	Number of Wall Ties	Number of Airvents	Number of Blanking Plugs	Price Ex VAT	Price Inc VAT
DELIVERY TIMES					48-72 HOURS	
Single Wall Tie	PPANWT	1	N/A	N/A	£68.00	£81.60
Single Airvent & Blanking Plug	PPLAVBP	N/A	1	1	£18.00	£21.60
Wall Tie, Airvent & Blanking Plug Kit	PPANWTAVKIT2	2	1	1	£149.00	£178.80
Wall Tie, Airvent & Blanking Plug Kit	PPANWTAVKIT3	3	1	1	£211.00	£253.20
Wall Tie, Airvent & Blanking Plug Kit	PPANWTAVKIT4	4	1	1	£276.00	£331.20
Wall Tie, Airvent & Blanking Plug Kit	PPANWTAVKIT5	5	1	1	£340.00	£408.00

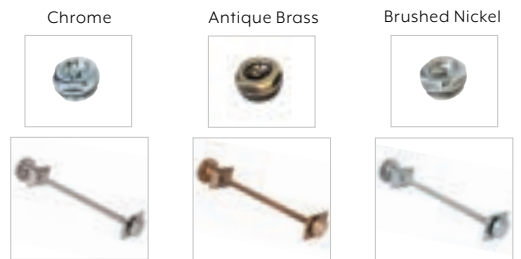

Optional Antique Copper Airvent & Blanking Plug

Our Antique Copper Airvent & Blanking Plug is an ideal match for the Pearl Bronze Feature Finish (pictured right) on your Ancona radiator.

Description	Model	Price Ex VAT	Price Inc VAT
DELIVERY TIMES			
Single Antique Copper Airvent & Blanking Plug	PPLAVBPAC	£18.00	£21.60



Manual Brass Airvents

As an alternative, why not order an Ancona® manual brass airvent to co-ordinate with your chosen colour or to match your valve. 1 airvent is needed per Ancona® radiator; please specify at time of order. **Available from stock.**

Description	Model	Price Ex VAT	Price Inc VAT
DELIVERY TIMES			
Brass airvent	PPAVB	£4.00	£4.80



® Ancona is a registered trademark of IRSAP UK Limited

A nominal £5 charge for postage & packing will be applied to any orders under £50 in value.

Ancona® Stock shown on pages 8-17



High quality Italian design & manufacture.
Steel multi column 45mm sections. CE/UKCA approved & certified to BS EN442.

White RAL 9016 as standard, Feature Finishes: Copper, Pearl Bronze, Textured Anthracite, Vintage Green, Aged Brass and Satin Gold.
(Please call **01342 302250** for sample swatches). Colour Coordination Service available, **see page 217** for full details.

Stock White RAL 9016: 48-72 Hours
Feature Finishes: Up to 2 weeks



45



All sections
45mm wide



SAVE £45*

WHEN YOU BUY OUR VINTAGE TRV & PIPE COVERS WITH ANY ANCONA® PURCHASE.
QUOTE **PROMOV2** AT TIME OF ORDER.

*Saving based on the value of individual items when bought separately.
Order any of our selected valves and matching pipe covers at the same time as your radiator.

Online Radiator Builder

Use our **ONLINE RADIATOR BUILDER** to help you select the best solution for your room. It will take you through the process quickly and easily and allows you to save your ideas to your own Wish List. To select the right size of radiator for your room you need to calculate the BTU (heat output) you require to heat your room, you can use our online calculator to work this out. Go to our new website **theradiatorcompany.co.uk**



- 1 Calculate the heat output you need for your room, using our **online BTU (Heat Output) Calculator** or check with your installer, remember you may need more than one radiator to heat your room.
- 2 Use the tables on **pages 130-137** to find the best size to suit your space and heat output you need; if you cannot get the right size and output combination from a 2 column radiator try an alternative height or column (depth) option.
- 3 Choose the style of mounting option you want; for Ancona stock white & Feature Finishes standard wall brackets are included in the radiator price, for Bare Metal Lacquer Ancona stock universal wall brackets only are included in the price
- 4 If selecting cast feet or Slip-on Welded Feet there is an additional cost, see right for Cast Feet and Slip-on Welded Feet Kits and **page 137** for bare metal lacquer Slip-on Welded Feet pricing tables.

If you need an alternative size, there are thousands of other sizes we can make to order from the full Ancona range which can be found on **pages 140-143**

Ancona® Stock White & Feature Finishes Mounting Options

Mounting Options for Ancona Stock in White & Feature Finishes, (Bare Metal Lacquer mounting options can be found on page 137)

Once you have chosen your radiator size simply choose your preferred mounting option; standard wall brackets are included in the radiator price. Cast Feet and Slip-on Welded Feet are an additional cost, see pricing tables below.

We will supply the correct number of brackets and wall ties with each order; prices for extra brackets / feet and wall ties are available on request, please call **01342 302250**.

Note: Anconas over 40 sections will incur a £35 joining charge, please see bottom of this page for more information

Please specify your preferred mounting option at time of order (remember cast feet and slip on welded feet are not included in the radiator price)

Note: Anconas must be a minimum of 100mm from the floor for all mounting options

Wall mounting options included in radiator price

Standard wall brackets

Supplied as standard with every Ancona order unless an alternative is specified.

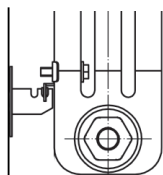

Pipe centres from wall:
 2 column = 64mm - 74mm
 3 column = 82mm - 92mm
 4 column = 102mm - 112mm

Wall ties



adjustable from 32mm to 42mm

Optional Cast Feet kit prices (includes wall ties)

Section & Column Range	No. of Feet	Model	White Ex VAT	White Inc VAT	Feature Finishes Ex VAT	Feature Finishes Inc VAT
DELIVERY TIMES			48-72 HOURS		UP TO 2 WEEKS	
2-20 Sections / 2-4 Columns	2	PPANCSCFKIT2	£60.00	£72.00	£75.00	£90.00
21-30 Sections / 2-4 Columns	3	PPANCSCFKIT3	£90.00	£108.00	£112.50	£135.00
31-40 Sections / 2-4 Columns	4	PPANCSCFKIT4	£120.00	£144.00	£150.00	£180.00

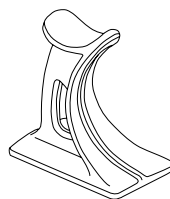

100

Pipe centres from wall:
 2 column = 64mm - 74mm
 3 column = 82mm - 92mm
 4 column = 102mm - 112mm

Note: Please remember to add 100mm to the height of the Ancona section you have chosen if you are using cast feet.

Optional Slip-on Welded Feet kit prices (includes wall ties)

Sections	No. of Feet	Model	White Ex VAT	White Inc VAT	Feature Finishes Ex VAT	Feature Finishes Inc VAT
DELIVERY TIMES			48-72 HOURS		UP TO 2 WEEKS	
Up to 20 Sections	2	PPANCSSOFKIT2	£98.00	£117.60	£131.32	£157.58
21-39 (odd number of sections)	3	PPANCSSOFKIT3	£147.00	£176.40	£196.98	£236.38
22-40 (even number of sections)	4	PPANCSSOFKIT4	£196.00	£235.20	£262.64	£315.17

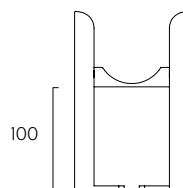

100

Pipe centres from wall:
 2 column = 64mm - 74mm
 3 column = 82mm - 92mm
 4 column = 102mm - 112mm

Note: Please remember to add 100mm to the height of the Ancona section you have chosen if you are using slip on welded feet.

Nylon Spanner

The perfect tool for tightening Ancona Bushes and air vents. An exact fit, this robust nylon spanner reduces the risk of damaging your radiator with inappropriate metal tools.

Description	Model	Price Ex VAT	Price Inc VAT
DELIVERY TIMES		48-72 HOURS	
Nylon Spanner	MCSPANNER	£12.00	£14.40



Helpful notes & advice

Please call us on **01342 302250** if you need any further information or help with specifying your Ancona.

Due to transport and handling restrictions, Stock Anconas are supplied pre-assembled up to a maximum of 40 sections. For radiators outside these parameters there is an additional joining charge, please consult Customer Services to discuss alternative requirements. All Anconas come supplied as a finished radiator with ½" B.O.E. (Bottom Opposite End) connections as standard.

A nominal £5 charge for postage and packing will be applied to any orders under £50 in value.

1800mm High

Width (mm)	Sections	Model	Watts At 50°C	Btu's At 50°C	White Ex VAT	White Inc VAT	Feature Finishes Ex VAT	Feature Finishes Inc VAT
DELIVERY TIMES					48-72 HOURS		UP TO 2 WEEKS	
161	3	ANCS2C18X3	372	1269	£177.81	£213.37	£265.23	£318.28
206	4	ANCS2C18X4	496	1692	£237.08	£284.50	£353.64	£424.37
251	5	ANCS2C18X5	620	2115	£296.35	£355.62	£442.05	£530.46
296	6	ANCS2C18X6	744	2539	£355.62	£426.74	£530.46	£636.55
341	7	ANCS2C18X7	868	2962	£414.89	£497.87	£618.87	£742.64
386	8	ANCS2C18X8	992	3385	£474.16	£568.99	£707.28	£848.74
431	9	ANCS2C18X9	1116	3808	£533.43	£640.12	£795.69	£954.83
476	10	ANCS2C18X10	1240	4231	£592.70	£711.24	£884.10	£1,060.92
521	11	ANCS2C18X11	1364	4654	£651.97	£782.36	£972.51	£1,167.01
566	12	ANCS2C18X12	1488	5077	£711.24	£853.49	£1,060.92	£1,273.10
611	13	ANCS2C18X13	1612	5500	£770.51	£924.61	£1,149.33	£1,379.20
656	14	ANCS2C18X14	1736	5923	£829.78	£995.74	£1,237.74	£1,485.29
701	15	ANCS2C18X15	1860	6346	£889.05	£1,066.86	£1,326.15	£1,591.38
746	16	ANCS2C18X16	1984	6769	£948.32	£1,137.98	£1,414.56	£1,697.47
791	17	ANCS2C18X17	2108	7192	£1,007.59	£1,209.11	£1,502.97	£1,803.56
836	18	ANCS2C18X18	2232	7616	£1,066.86	£1,280.23	£1,591.38	£1,909.66
881	19	ANCS2C18X19	2356	8039	£1,126.13	£1,351.36	£1,679.79	£2,015.75
926	20	ANCS2C18X20	2480	8462	£1,185.40	£1,422.48	£1,768.20	£2,121.84

Widths include measurement for bushes.

Please note due to manufacturing tolerances widths shown may vary by +/- 2mm.

Feature Finishes

See page 7 for more details or call customer services for sample swatches.

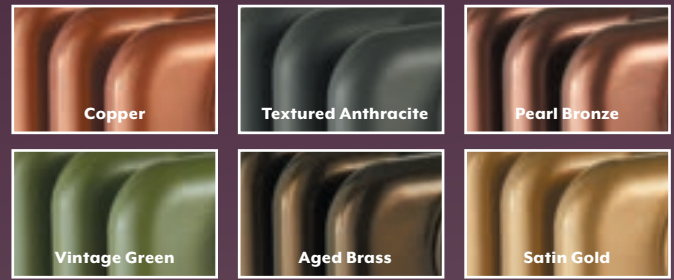

Mounting options for stock sizes

Once you have chosen your radiator size, simply choose your preferred mounting option; standard wall brackets are included in the radiator price.

Floor mounting options

Cast feet and Slip-on Welded Feet are an additional cost, see pricing tables below.

We will supply the correct number of brackets and wall ties with each order; prices for extra brackets / feet and wall ties are available on request, please call 01342 302250. Ancona's must be a minimum of 100mm from the floor for all mounting options.

Note: Ancona's over 40 sections will incur a £35 joining charge, please see bottom of page 129 for more information.

Wall mounting options included in radiator price

Standard Wall Brackets

These will always be supplied with every Ancona order unless an alternative is specified at time of order

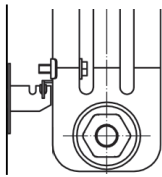

Pipe centres from wall:

2 column = 64mm - 74mm

3 column = 82mm - 92mm

4 column = 102mm - 112mm

Wall ties



adjustable from 32 to 42mm

Optional Cast Feet kit prices (includes wall ties)

Section & Column Range	No. of Feet	Model	White Ex VAT	White Inc VAT	Feature Finishes Ex VAT	Feature Finishes Inc VAT
DELIVERY TIMES			48-72 HOURS		UP TO 2 WEEKS	
2-20 Sections / 2-4 Columns	2	PPANCSCFKIT2	£60.00	£72.00	£75.00	£90.00
21-30 Sections / 2-4 Columns	3	PPANCSCFKIT3	£90.00	£108.00	£112.50	£135.00
31-40 Sections / 2-4 Columns	4	PPANCSCFKIT4	£120.00	£144.00	£150.00	£180.00

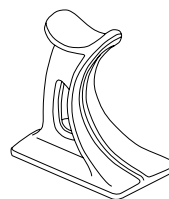

100

Pipe centres from wall:

2 column = 64mm - 74mm

3 column = 82mm - 92mm

4 column = 102mm - 112mm

Note: Please remember to add 100mm to the height of the Ancona section you have chosen if you are using cast feet.

Optional Slip-on Welded Feet kit prices (includes wall ties)

Sections	No. of Feet	Model	White Ex VAT	White Inc VAT	Feature Finishes Ex VAT	Feature Finishes Inc VAT
DELIVERY TIMES			48-72 HOURS		UP TO 2 WEEKS	
Up to 20 Sections	2	PPANCSSOFKIT2	£98.00	£117.60	£131.32	£157.58
21-39 (odd number of sections)	3	PPANCSSOFKIT3	£147.00	£176.40	£196.98	£236.38
22-40 (even number of sections)	4	PPANCSSOFKIT4	£196.00	£235.20	£262.64	£315.17

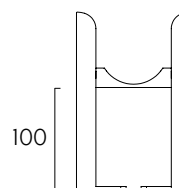

100

Pipe centres from wall:

2 column = 64mm - 74mm

3 column = 82mm - 92mm

4 column = 102mm - 112mm

Note: Please remember to add 100mm to the height of the Ancona section you have chosen if you are using Slip-on Welded Feet.

Ancona® Bare Metal Lacquers shown on pages 16-17

High quality Italian design & manufacture.
 Steel multi column (2, 3 and 4 column options)
 45mm sections.
 CE/UKCA approved & certified to BS EN442.

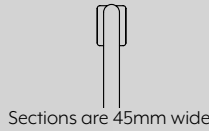

Bare Metal Lacquer as standard
 NEW Tinted Lacquers Copper and Brass

Bare Metal Lacquer: 48-72 Hours
 Tinted Lacquers (Copper and Brass): Up to 2 weeks

All prices include universal wall brackets (optional slip-on feet shown page 137).
 The radiators widths include bushes.
 Pipe centres left to right = width + valves.

SAVE £45*
 WHEN YOU BUY OUR VINTAGE TRV & PIPE COVERS WITH ANY ANCONA® PURCHASE QUOTING PROMOV2 AT TIME OF ORDER.



For all Vintage TRV finishes see page 122

This finish highlights the raw basic steel product showcasing the manufacturing marks created by the processes of welding and sanding to deliver an industrial look. Each radiator will be unique, with the random position of the weld lines on the column tubes and the level of the final sanding. The clear lacquer allows these characteristics to be the hero and maintains the natural steel finish. Please **see page 137** (right) for examples of weld lines and sanding marking. Our new tinted lacquers add an extra dimension whilst retaining the individual nature of the raw finish marks.

2 Column - 1800mm High

Additional surcharge for tinted lacquers - £17.00 (Ex VAT) £20.40 (Inc VAT) per individual section.

DELIVERY TIMES					48-72 HOURS		DELIVERY TIMES					48-72 HOURS	
Width (mm)	Sections	Model	Watts Δt 50°C	Btu's Δt 50°C	Bare Metal Lacquer Ex VAT	Inc VAT	Width (mm)	Sections	Model	Watts Δt 50°C	Btu's Δt 50°C	Bare Metal Lacquer Ex VAT	Inc VAT
161	3	ANCS2C18X3L	372	1269	£222.27	£266.72	566	12	ANCS2C18X12L	1488	5077	£889.08	£1,066.90
206	4	ANCS2C18X4L	496	1692	£296.36	£355.63	611	13	ANCS2C18X13L	1612	5500	£963.17	£1,155.80
251	5	ANCS2C18X5L	620	2115	£370.45	£444.54	656	14	ANCS2C18X14L	1736	5923	£1,037.26	£1,244.71
296	6	ANCS2C18X6L	744	2539	£444.54	£533.45	701	15	ANCS2C18X15L	1860	6346	£1,111.35	£1,333.62
341	7	ANCS2C18X7L	868	2962	£518.63	£622.36	746	16	ANCS2C18X16L	1984	6769	£1,185.44	£1,422.53
386	8	ANCS2C18X8L	992	3385	£592.72	£711.26	791	17	ANCS2C18X17L	2108	7192	£1,259.53	£1,511.44
431	9	ANCS2C18X9L	1116	3808	£666.81	£800.17	836	18	ANCS2C18X18L	2232	7616	£1,333.62	£1,600.34
476	10	ANCS2C18X10L	1240	4231	£740.90	£889.08	881	19	ANCS2C18X19L	2356	8039	£1,407.71	£1,689.25
521	11	ANCS2C18X11L	1364	4654	£814.99	£977.99	926	20	ANCS2C18X20L	2480	8462	£1,481.80	£1,778.16

Widths include measurement for bushes. Please note due to manufacturing tolerances widths shown may vary by +/- 2mm.

3 Column - 500mm High

Additional surcharge for tinted lacquers - £11.00 (Ex VAT) £13.20 (Inc VAT) per individual section.

DELIVERY TIMES					48-72 HOURS		DELIVERY TIMES					48-72 HOURS	
Width (mm)	Sections	Model	Watts Δt 50°C	Btu's Δt 50°C	Bare Metal Lacquer Ex VAT	Inc VAT	Width (mm)	Sections	Model	Watts Δt 50°C	Btu's Δt 50°C	Bare Metal Lacquer Ex VAT	Inc VAT
161	3	ANCS3C50X3L	153	522	£120.90	£145.08	1016	22	ANCS3C50X22L	1122	3828	£886.60	£1,063.92
206	4	ANCS3C50X4L	204	696	£161.20	£193.44	1061	23	ANCS3C50X23L	1173	4002	£926.90	£1,112.28
251	5	ANCS3C50X5L	255	870	£201.50	£241.80	1106	24	ANCS3C50X24L	1224	4176	£967.20	£1,160.64
296	6	ANCS3C50X6L	306	1044	£241.80	£290.16	1151	25	ANCS3C50X25L	1275	4350	£1,007.50	£1,209.00
341	7	ANCS3C50X7L	357	1218	£282.10	£338.52	1196	26	ANCS3C50X26L	1326	4524	£1,047.80	£1,257.36
386	8	ANCS3C50X8L	408	1392	£322.40	£386.88	1241	27	ANCS3C50X27L	1377	4698	£1,088.10	£1,305.72
431	9	ANCS3C50X9L	459	1566	£362.70	£435.24	1286	28	ANCS3C50X28L	1428	4872	£1,128.40	£1,354.08
476	10	ANCS3C50X10L	510	1740	£403.00	£483.60	1331	29	ANCS3C50X29L	1479	5046	£1,168.70	£1,402.44
521	11	ANCS3C50X11L	561	1914	£443.30	£531.96	1376	30	ANCS3C50X30L	1530	5220	£1,209.00	£1,450.80
566	12	ANCS3C50X12L	612	2088	£483.60	£580.32	1421	31	ANCS3C50X31L	1581	5394	£1,249.30	£1,499.16
611	13	ANCS3C50X13L	663	2262	£523.90	£628.68	1466	32	ANCS3C50X32L	1632	5568	£1,289.60	£1,547.52
656	14	ANCS3C50X14L	714	2436	£564.20	£677.04	1511	33	ANCS3C50X33L	1683	5742	£1,329.90	£1,595.88
701	15	ANCS3C50X15L	765	2610	£604.50	£725.40	1556	34	ANCS3C50X34L	1734	5916	£1,370.20	£1,644.24
746	16	ANCS3C50X16L	816	2784	£644.80	£773.76	1601	35	ANCS3C50X35L	1785	6090	£1,410.50	£1,692.60
791	17	ANCS3C50X17L	867	2958	£685.10	£822.12	1646	36	ANCS3C50X36L	1836	6264	£1,450.80	£1,740.96
836	18	ANCS3C50X18L	918	3132	£725.40	£870.48	1691	37	ANCS3C50X37L	1887	6438	£1,491.10	£1,789.32
881	19	ANCS3C50X19L	969	3306	£765.70	£918.84	1736	38	ANCS3C50X38L	1938	6612	£1,531.40	£1,837.68
926	20	ANCS3C50X20L	1020	3480	£806.00	£967.20	1781	39	ANCS3C50X39L	1989	6786	£1,571.70	£1,886.04
971	21	ANCS3C50X21L	1071	3654	£846.30	£1,015.56	1826	40	ANCS3C50X40L	2040	6960	£1,612.00	£1,934.40

Widths include measurement for bushes. Please note due to manufacturing tolerances widths shown may vary by +/- 2mm.

2 Column - 65mm



3 Column - 101mm



4 Column - 139mm



Ancona® Made to Order shown on pages 18-25

High quality Italian design & manufacture.
Steel multi column 45mm sections, 2-6 column options
CE/UKCA approved & certified to BS EN442.



White RAL 9016 as standard, 188 RAL colours and 32 Special Finishes
Please call **01342 302250** for a RAL or Special Finish chart

Made to Order: Up to 4 weeks White & Colours
Up to 6 weeks Bare Metal Lacquer.



Vintage TRV & Pipe Covers

SAVE £45*

WHEN YOU BUY OUR VINTAGE TRV & PIPE COVERS WITH ANY ANCONA® PURCHASE QUOTING PROMOV2 AT TIME OF ORDER.

For all Vintage TRV finishes see page 122

Create a radiator that matches your exact requirements with thousands of sizes, plus a choice of 188 RAL colours and 31 special finishes and a bare metal lacquer finish.

Choose your radiator using our online radiator builder

It is vital to know the correct heat output you need to keep your room warm, use our online BTU (heat output) calculator to get a guide to your requirements which you can then check with your installer.

Once you know your outputs use our online radiator builder to select the best solution for your room. It will take you through the process quickly and easily and allows you to save your ideas to your own Wish List. Go to our website theradiatorcompany.co.uk

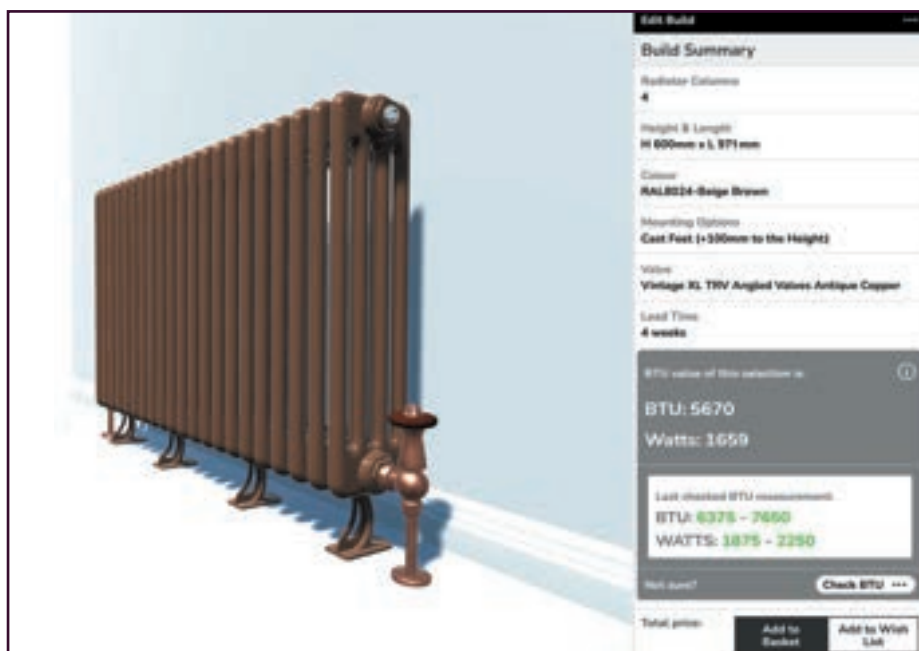

Once you know your outputs you can use the brochure to specify your radiator by following these steps (or call our Customer Services team on **01342 302250** who will help you size your radiator).

- Note the space you have in mind for the radiator(s) you need; vertical or horizontal, length, height & depth
- Select a column option and height that fits your space; Calculate the number of sections you need by dividing the required BTU (Watt) output with the output per section; e.g 4142 BTUs divided by 205 = 20 sections, based on 3 column, 600mm high sections (always round up to the next whole number of sections).
- If the use of this section size does not work in the available space, try a different column option or if possible a different height.
- Once you have calculated the best number and size of sections, select the best mounting option. Wall hung options (standard wall brackets) are included in your radiator price. Cast Feet or Welded Feet are an additional cost, **see kit prices on page 143**. Choose your colour from over 200 colours and special finishes; white RAL 9016 or 9010 are our standard finishes.
- Work out the price of your radiator; e.g 3 column 600mm high, white, 20 sections x £39.07 = £781.40 + welded feet kit price £146.40 = £927.80 (inc VAT).
- Place your order with your local Merchant using the Sectional Model Code x No. of Sections needed, noting the Mounting Option and the name and number of the colour you have chosen; e.g ANCO360W x 20 sections, RAL 9016 Traffic white, with welded feet.
- If you have chosen a colour use the colour reference 'R' instead of 'W' and list the colour number and name.

All prices and outputs are given per section in the tables on **pages 140-141**. Price per section includes plugs, bushes and diverter. Mounting options must be selected separately, these will include the air vent and appropriate number of wall ties.

*Saving based on the value of individual items when bought separately. Order any of our selected valves and matching pipe covers at the same time as your radiator.

Ancona® Made to Order - Colours & Special Finishes

The Ancona® made to order range is available in 188 RAL colours including our standard White RAL 9016, a bright porcelain white. We also offer 32 special finishes including Gun Metal Grey, Mottled Silver and Copper, Metallics, Pastels, Golds & a Bare Metal Lacquer finish. Please call **01342 302250** for a RAL chart & Special Finish chart.



188 RAL Colours

Match your room style by selecting from a full rainbow of 188 RAL colours. Use either contrasting colours to create a bold statement or sympathetic colours so your Ancona® blends in to your wall.



32 Special Finishes including a Bare Metal Lacquer finish

There are 32 colours to choose from including: pastels, matts, metallics, mottled, textured effects, as well as bare metal lacquer finish, for a Special Finish chart please call our Customer Service team on **01342 302250**.



Textured Black Matt



Matt Beige



Mottled Silver



Gun Metal Grey



Rose Blush



Sage Green

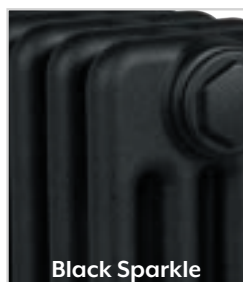

Black Sparkle



Bare Metal Lacquer



Red Oxide

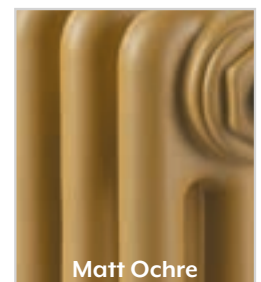

Matt Ochre

Helpful notes & advice

Please call us on **01342 302250** if you need any further information or help with specifying your Ancona®.

Ancona® sections are 45mm wide, therefore the total radiator length is; "no. of Sections x 45mm + 26mm for bushes + valves" (*Please note due to manufacturing tolerances widths shown may vary by +/- 2mm*). When considering the height of your radiator remember that your mounting option will affect the overall height of your radiator. Made To Order Anconas® are supplied factory assembled up to a maximum of 40 sections. For radiators outside these parameters there is an additional joining charge. Please consult Customer Services to discuss alternative requirements.

Ancona® Made to Order shown on pages 18-25

Specify your radiator online; Use our **Online Radiator Builder** to quickly and easily specify your radiator.

Go to our website theradiatorcompany.co.uk.

Use these tables to specify your radiator by following these steps;

- 1 Calculate the heat output you need for your room, using our online **BTU (Heat Output) Calculator** or check with your installer, remember you may need more than one radiator to heat your room.
- 2 Use the tables below & right to find the best size to suit your space and heat output you need; if you cannot get the right size & output combination from a 2 column radiator try an alternative height or column (depth) option, **see page 138** for more details on how to size your radiator.
- 3 Choose the style of mounting option you want; standard wall brackets are included in the radiator price (universal wall brackets for lacquer finishes). If selecting cast feet or welded feet there is an additional cost, see pricing tables on **page 143**.
- 4 Choose your colour from a choice of 188 RAL colours and 32 special finishes including bare metal lacquer, **see page 139**.

All prices and outputs are given per section in the tables below. Price per section includes plugs, bushes, diverter, wall brackets and wall ties.

Alternative mounting options must be selected separately, these will include the air vent and appropriate number of wall ties.

Made To Order Anconas® are supplied factory assembled up to a maximum of 40 sections. For radiators outside these parameters, there is an additional joining charge. Please consult Customer Services to discuss alternative requirements.

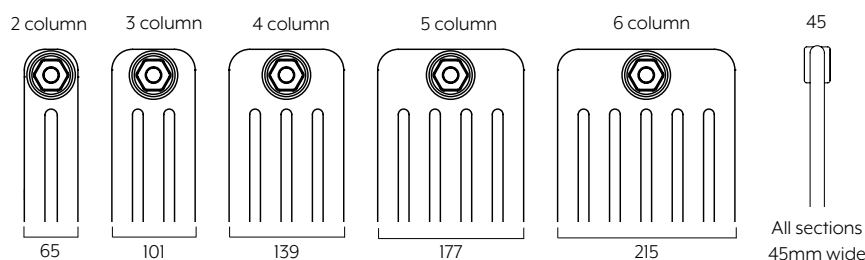

Pipe Centres for all White & Colour Anconas with Cast Feet, Welded Feet or Wall Brackets are;	
Pipe centres left to right = number of sections x 45mm plus 26mm (13mm each) for bushes plus valves. <i>Note due to manufacturing tolerances widths may vary by +/- 2mm.</i>	
Pipe centres from wall (based on adjustable wall ties)	2 Column = 64mm to 74mm 3 Column = 82mm to 92mm 4 Column = 102mm to 112mm 5 Column = 120mm to 130mm 6 Column = 140mm to 150mm

Sections

2 Column - 65mm Deep

Height (mm)	Width (mm)	Model	Watts Δt 50°C	Btu's Δt 50°C	White Ex VAT	White Inc VAT	Colours & Lacquer		Colours & Lacquer	
							Ex VAT	Inc VAT	Ex VAT	Inc VAT
DELIVERY TIMES					UP TO 4 WEEKS		4-6 WEEKS			
195	45	ANCO2C19	14	48	£24.51	£29.41	£30.64	£36.77		
300	45	ANCO2C30	23	78	£25.89	£31.07	£32.36	£38.83		
350	45	ANCO2C35	26	89	£26.63	£31.96	£33.29	£39.95		
365	45	ANCO2C36	27	92	£26.75	£32.10	£33.44	£40.13		
400	45	ANCO2C40	30	102	£26.95	£32.34	£33.69	£40.43		
450	45	ANCO2C45	33	113	£27.67	£33.20	£34.59	£41.51		
500	45	ANCO2C50	36	123	£27.88	£33.46	£34.85	£41.82		
550	45	ANCO2C55	39	133	£28.19	£33.83	£35.24	£42.29		
565	45	ANCO2C56	40	136	£28.26	£33.91	£35.33	£42.40		
600	45	ANCO2C60	43	147	£28.45	£34.14	£35.56	£42.67		
650	45	ANCO2C65	46	157	£28.50	£34.20	£35.63	£42.76		
665	45	ANCO2C66	47	160	£29.04	£34.85	£36.30	£43.56		
685	45	ANCO2C68	48	164	£29.38	£35.26	£36.73	£44.08		
750	45	ANCO2C75	52	177	£29.54	£35.45	£36.93	£44.32		
765	45	ANCO2C76	53	181	£31.61	£37.93	£39.51	£47.41		
865	45	ANCO2C86	60	205	£32.99	£39.59	£41.24	£49.49		
885	45	ANCO2C88	61	208	£33.19	£39.83	£41.49	£49.79		
900	45	ANCO2C90	62	212	£33.52	£40.22	£41.90	£50.28		
1000	45	ANCO2C10	69	235	£34.76	£41.71	£43.45	£52.14		
1200	45	ANCO2C12	82	280	£40.62	£48.74	£50.78	£60.94		
1500	45	ANCO2C15	103	351	£48.95	£58.74	£61.19	£73.43		
1800	45	ANCO2C18	124	423	£59.27	£71.12	£74.09	£88.91		
2000	45	ANCO2C20	139	474	£67.24	£80.69	£84.05	£100.86		
2200	45	ANCO2C22	154	525	£73.61	£88.33	£92.01	£110.41		
2500	45	ANCO2C25	177	604	£84.26	£101.11	£105.33	£126.40		

Please note Bare Metal Lacquer is not available in 195mm high

3 Column - 101mm Deep

Height (mm)	Width (mm)	Model	Watts Δt 50°C	Btu's Δt 50°C	White Ex VAT	White Inc VAT	Colours & Lacquer		Colours & Lacquer	
							Ex VAT	Inc VAT	Ex VAT	Inc VAT
DELIVERY TIMES					UP TO 4 WEEKS		4-6 WEEKS			
195	45	ANCO3C19	20	68	£26.31	£31.57	£32.89	£39.47		
300	45	ANCO3C30	32	109	£28.41	£34.09	£35.51	£42.61		
350	45	ANCO3C35	37	126	£29.65	£35.58	£37.06	£44.47		
365	45	ANCO3C36	38	130	£29.97	£35.96	£37.46	£44.95		
400	45	ANCO3C40	42	143	£30.70	£36.84	£38.38	£46.06		
450	45	ANCO3C45	46	157	£31.61	£37.93	£39.51	£47.41		
500	45	ANCO3C50	51	174	£32.24	£38.69	£40.30	£48.36		
550	45	ANCO3C55	55	188	£32.36	£38.83	£40.45	£48.54		
565	45	ANCO3C56	57	194	£32.50	£39.00	£40.63	£48.76		
600	45	ANCO3C60	60	205	£32.56	£39.07	£40.70	£48.84		
650	45	ANCO3C65	65	222	£33.87	£40.64	£42.34	£50.81		
665	45	ANCO3C66	66	225	£34.38	£41.26	£42.98	£51.58		
685	45	ANCO3C68	68	232	£35.12	£42.14	£43.90	£52.68		
750	45	ANCO3C75	74	252	£35.37	£42.44	£44.21	£53.05		
765	45	ANCO3C76	75	256	£38.83	£46.60	£48.54	£58.25		
865	45	ANCO3C86	84	287	£39.06	£46.87	£48.83	£58.60		
885	45	ANCO3C88	86	293	£39.57	£47.48	£49.46	£59.35		
900	45	ANCO3C90	87	297	£39.89	£47.87	£49.86	£59.83		
1000	45	ANCO3C10	96	328	£41.87	£50.24	£52.34	£62.81		
1200	45	ANCO3C12	114	389	£53.56	£64.27	£66.95	£80.34		
1500	45	ANCO3C15	141	481	£71.52	£85.82	£89.40	£107.28		
1800	45	ANCO3C18	168	573	£77.54	£93.05	£96.93	£116.32		
2000	45	ANCO3C20	187	638	£92.81	£111.37	£116.01	£139.21		
2200	45	ANCO3C22	205	699	£105.03	£126.04	£131.29	£157.55		
2500	45	ANCO3C25	233	795	£114.09	£136.91	£142.61	£171.13		

Please note Bare Metal Lacquer is not available in 195mm high

Ancona® Made to Order - Wall Brackets

Once you have chosen your radiator size you can choose any one of our 3 mounting options & specify at time of order (fittings are available to order with a corresponding radiator only).

Standard wall brackets are included in your radiator price. The correct number of brackets and wall ties will be supplied with each order; prices for extra wall brackets and wall ties are available on request, please call **01342 302250**.

Technical & pipe centre information of each mounting option is shown below / right.

Please note: Anconas® in a bare metal lacquer finish are only available to be mounted with universal wall brackets or welded feet.



*PPANCOWNB

Standard wall brackets technical & pipe centre information (suitable for stud walls) (appropriate for all finishes except Bare Metal Lacquer)

Can be positioned at any height (minimum height from floor 100mm); brackets are supplied with raw plugs.

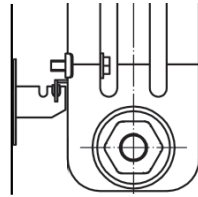

Pipe centres from wall:
 2 column = 64mm - 74mm
 3 column = 82mm - 92mm
 4 column = 102mm - 112mm
 5 column = 120mm - 130mm
 6 column = 140mm - 150mm



Wall tie; adjustable from 32mm to 42mm



*PPANCOWNB

Bare metal lacquer universal wall brackets (suitable for stud walls)

Note: Ancona's with lacquer wall brackets can be positioned at any height (minimum 100mm from floor)

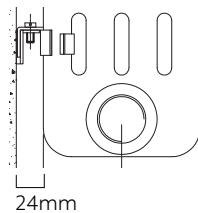

Pipe centres from wall:
 2 column = 56mm
 3 column = 74mm
 4 column = 93mm
 5 column = 112mm
 6 column = 131mm

Build your radiator using our online radiator builder on our new and improved website

It is vital to know the correct heat output you need to keep your room warm, use our **online BTU (heat output) calculator** to get a guide to your requirements which you can then check with your installer.

Once you know your outputs use our **online radiator builder** to select the best solution for your room. It will take you through the process quickly and easily and allows you to save your ideas to your own Wish List. Please go to our website **theradiatorcompany.co.uk**

Optional Solid Brass Wall Ties & Airvents

These solid brass wall ties provide a stylish finishing touch to any Ancona® radiator; select to match your valves. Available as a kit including matching airvent in Antique Brass, Chrome and Brushed Nickel.

Please note that these wall ties and airvents are an optional extra and do not come as standard with your Ancona® radiator.

Description	Model	Number of Wall Ties	Number of Airvents	Number of Blank Plugs	Price Ex VAT	Price Inc VAT
DELIVERY TIMES					48-72 HOURS	
Single Wall Tie	PPANWT	1	N/A	N/A	£68.00	£81.60
Single Airvent & Blank Plug	PPLAVBP	N/A	1	1	£18.00	£21.60
Wall Tie, Airvent & Blank Plug Kit	PPANWTAVKIT2	2	1	1	£149.00	£178.80
Wall Tie, Airvent & Blank Plug Kit	PPANWTAVKIT3	3	1	1	£211.00	£253.20
Wall Tie, Airvent & Blank Plug Kit	PPANWTAVKIT4	4	1	1	£276.00	£331.20
Wall Tie, Airvent & Blank Plug Kit	PPANWTAVKIT5	5	1	1	£340.00	£408.00

Antique Brass

Chrome

Brushed Nickel

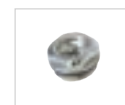
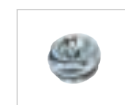

Please specify your finish at time of order.

Ancona® Made to Order - Floor Mounting Options

Once you have chosen your radiator size you can choose to have your Ancona® floor mounted by selecting either Welded or Cast Feet (fittings are available to order with a corresponding radiator only).

Please note; Welded Feet and Cast Feet are an additional cost to your radiator price.

The correct number of wall ties will be supplied with each order; prices for extra cast feet and wall ties are available on request, please call **01342 302250**.

Please specify your preferred floor mounting option & kit number at time of order. Technical & pipe centre information of each mounting option is shown below.

Cast feet kit prices

Note: please remember to add 100mm to the height of the Ancona® section you have chosen if you are using Cast Feet.

Section & Column Range	No. of Feet	Model	White Ex VAT	White Inc VAT	Colours Ex VAT	Colours Inc VAT
DELIVERY TIMES			UP TO 4 WEEKS		UP TO 4 WEEKS	
2-20 Sections / 2-6 Columns	2	PPANCOCFKIT2	£60.00	£72.00	£75.00	£90.00
21-30 Sections / 2-6 Columns	3	PPANCOCFKIT3	£90.00	£108.00	£112.50	£135.00
31-40 Sections / 2-6 Columns	4	PPANCOCFKIT4	£120.00	£144.00	£150.00	£180.00

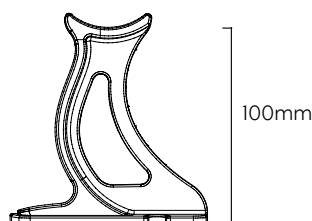

Cast Feet pipe centres



Pipe centres from wall:
 2 column = 64mm - 74mm
 3 column = 82mm - 92mm
 4 column = 102mm - 112mm
 5 column = 120mm - 130mm
 6 column = 140mm - 150mm



Wall tie; adjustable from 32mm to 42mm

Please note: cast feet are not available for bare metal lacquer finishes

*PPANCOCFK

Welded Feet kit prices

Note: Please remember to add 97mm to the height of the Ancona® section you have chosen if you are using Welded Feet.

Sections	No. of Feet	Model	White Ex VAT	White Inc VAT	Colours & Lacquer Ex VAT	Colours & Lacquer Inc VAT
DELIVERY TIMES			UP TO 4 WEEKS		4-6 WEEKS	
Up to 20 Sections	2	PPANCOWFKIT2	£122.00	£146.40	£152.50	£183.00
21-39 (odd number of sections)	3	PPANCOWFKIT3	£183.00	£219.60	£228.75	£274.50
22-40 (even number of sections)	4	PPANCOWFKIT4	£244.00	£292.80	£305.00	£366.00

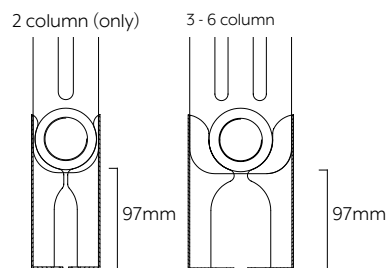

White & colour Welded Feet pipe centres



Pipe centres from wall:
 2 column = 64mm - 74mm
 3 column = 82mm - 92mm
 4 column = 102mm - 112mm
 5 column = 120mm - 130mm
 6 column = 140mm - 150mm

*PPANCOWF

Bare metal lacquer Welded Feet pipe centres



Pipe centres from wall:
 2 column = 56mm
 3 column = 74mm
 4 column = 93mm
 5 column = 112mm
 6 column = 131mm

*PPANCOWF

Anconas® with Welded Feet are supplied with the correct number of feet (see above); additional Welded Feet cannot be ordered.

Ancona® Bench Seat Horizontal shown on page 26

High quality Italian design and manufacture
Steel multi column supplied with a wooden seat
CE/UKCA approved & certified to BS EN442



White RAL 9016 as standard, 188 RAL colours and 31 Special Finishes
Please call **01342 302250** for a RAL or Special Finish chart

Made to Order: Up to 4 weeks White & Colours



Vintage TRV & Pipe Covers 

SAVE £45*
WHEN YOU BUY OUR VINTAGE TRV & PIPE COVERS WITH ANY ANCONA® PURCHASE QUOTING PROMOV2 AT TIME OF ORDER.

For all Vintage TRV finishes see page I22

Height A (mm)	Radiator Width B (mm)	Bench Seat Width C (mm)	Columns	Sections	Model	Watts Δt 50°C	Btu's Δt 50°C	White Ex VAT	White Inc VAT	Colours Ex VAT	Colours Inc VAT	DELIVERY TIMES		
												UP TO 4 WEEKS	UP TO 4 WEEKS	UP TO 4 WEEKS
460	502	650	6	4	ANCB4S4665	383	1307	£1,726.00	£2,071.20	£2,157.50	£2,589.00	UP TO 4 WEEKS		
	667	815			ANCB4S4681	495	1689	£1,954.00	£2,344.80	£2,442.50	£2,931.00	UP TO 4 WEEKS		
	867	1015			ANCB4S4610	628	2143	£2,208.00	£2,649.60	£2,760.00	£3,312.00	UP TO 4 WEEKS		
	1202	1350			ANCB4S4613	845	2883	£2,440.00	£2,928.00	£3,050.00	£3,660.00	UP TO 4 WEEKS		
	1502	1650			ANCB4S4616	1036	3535	£2,668.00	£3,201.60	£3,335.00	£4,002.00	UP TO 4 WEEKS		
	1802	1950			ANCB4S4619	1226	4183	£2,845.00	£3,414.00	£3,556.25	£4,267.50	UP TO 4 WEEKS		
	2002	2150			ANCB4S4621	1352	4613	£2,994.00	£3,592.80	£3,742.50	£4,491.00	UP TO 4 WEEKS		
	2202	2350			ANCB4S4623	1477	5040	£3,274.00	£3,928.80	£4,092.50	£4,911.00	UP TO 4 WEEKS		
	2502	2650			ANCB4S4626	1665	5681	£3,400.00	£4,080.00	£4,250.00	£5,100.00	UP TO 4 WEEKS		
460	502	650	6	5	ANCB5S4665	479	1634	£1,776.00	£2,131.20	£2,220.00	£2,664.00	UP TO 4 WEEKS		
	667	815			ANCB5S4681	619	2112	£2,015.00	£2,418.00	£2,518.75	£3,022.50	UP TO 4 WEEKS		
	867	1015			ANCB5S4610	785	2678	£2,283.00	£2,739.60	£2,853.75	£3,424.50	UP TO 4 WEEKS		
	1202	1350			ANCB5S4613	1056	3603	£2,532.00	£3,038.40	£3,165.00	£3,798.00	UP TO 4 WEEKS		
	1502	1650			ANCB5S4616	1296	4422	£2,792.00	£3,350.40	£3,490.00	£4,188.00	UP TO 4 WEEKS		
	1802	1950			ANCB5S4619	1533	5231	£2,917.00	£3,500.40	£3,646.25	£4,375.50	UP TO 4 WEEKS		
	2002	2150			ANCB5S4621	1690	5766	£3,068.00	£3,681.60	£3,835.00	£4,602.00	UP TO 4 WEEKS		
	2202	2350			ANCB5S4623	1847	6302	£3,359.00	£4,030.80	£4,198.75	£5,038.50	UP TO 4 WEEKS		
	2502	2650			ANCB5S4626	2081	7100	£3,519.00	£4,222.80	£4,398.75	£5,278.50	UP TO 4 WEEKS		
505	502	650	6	6	ANCB6S5065	575	1962	£1,829.00	£2,194.80	£2,286.25	£2,743.50	UP TO 4 WEEKS		
	667	815			ANCB6S5081	742	2532	£2,078.00	£2,493.60	£2,597.50	£3,117.00	UP TO 4 WEEKS		
	867	1015			ANCB6S5010	941	3211	£2,351.00	£2,821.20	£2,938.75	£3,526.50	UP TO 4 WEEKS		
	1202	1350			ANCB6S5013	1267	4323	£2,635.00	£3,162.00	£3,293.75	£3,952.50	UP TO 4 WEEKS		
	1502	1650			ANCB6S5016	1555	5306	£2,931.00	£3,517.20	£3,663.75	£4,396.50	UP TO 4 WEEKS		
	1802	1950			ANCB6S5019	1839	6275	£3,082.00	£3,698.40	£3,852.50	£4,623.00	UP TO 4 WEEKS		
	2002	2150			ANCB6S5021	2027	6916	£3,239.00	£3,886.80	£4,048.75	£4,858.50	UP TO 4 WEEKS		
	2202	2350			ANCB6S5023	2216	7561	£3,563.00	£4,275.60	£4,453.75	£5,344.50	UP TO 4 WEEKS		
	2502	2650			ANCB6S5026	2497	8520	£3,751.00	£4,501.20	£4,688.75	£5,626.50	UP TO 4 WEEKS		

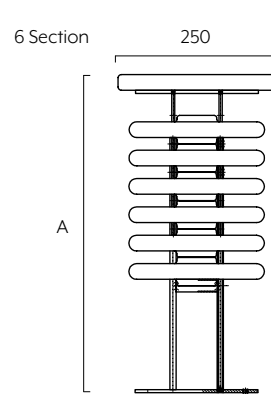
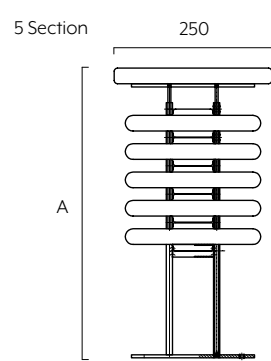
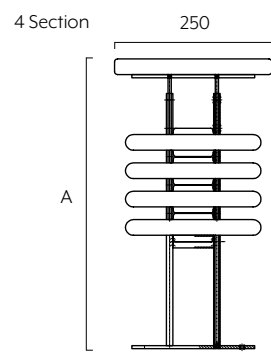

All prices shown include wooden seat.

Please note: Bench seats over 1650mm wide will be supplied with 3 feet.

Pipe centres = width (B) - 67mm

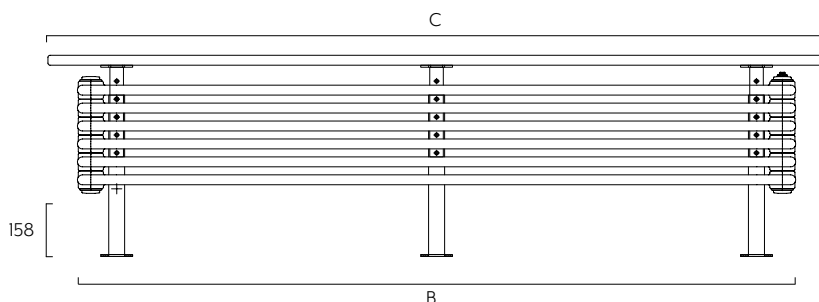

*Saving based on the value of individual items when bought separately. Order any of our selected valves and matching pipe covers at the same time as your radiator.

Ancona® Bench Seat Vertical shown on page 27

High quality Italian design and manufacture
Steel multi column supplied with a wooden seat
CE/UKCA approved & certified to BS EN442.



White RAL 9016 as standard, 188 RAL colours and 31 Special Finishes
Please call **01342 302250** for a RAL or Special Finish chart

Made to Order: Up to 5 weeks White & Colours



SAVE £45*
WHEN YOU BUY OUR VINTAGE TRV & PIPE COVERS WITH ANY ANCONA® PURCHASE QUOTING PROMOV2 AT TIME OF ORDER.

For all Vintage TRV finishes see page 122

Height A (mm)	Radiator Width B (mm)	Bench Seat Width C (mm)	Columns	Sections	Model	Watts Δt 50°C	Btu's Δt 50°C	White Ex VAT	White Inc VAT	Colours Ex VAT	Colours Inc VAT	DELIVERY TIMES		
												UP TO 5 WEEKS	UP TO 5 WEEKS	UP TO 5 WEEKS
496	1016	1350	4	22	ANCB4C22S	926	3160	£1,287.00	£1,544.40	£1,608.75	£1,930.50	UP TO 5 WEEKS		
	1286	1650		28	ANCB4C28S	1179	4023	£1,412.00	£1,694.40	£1,765.00	£2,118.00	UP TO 5 WEEKS		
	1466	1650		32	ANCB4C32S	1347	4596	£1,537.00	£1,844.40	£1,921.25	£2,305.50	UP TO 5 WEEKS		
	1646	1950		36	ANCB4C36S	1516	5173	£1,620.00	£1,944.00	£2,025.00	£2,430.00	UP TO 5 WEEKS		
	1736	1950		38	ANCB4C38S	1600	5459	£1,713.00	£2,055.60	£2,141.25	£2,569.50	UP TO 5 WEEKS		
	2051	2150		45	ANCB4C45S	1895	6466	£1,938.00	£2,325.60	£2,422.50	£2,907.00	UP TO 5 WEEKS		
	2366	2650		52	ANCB4C52S	2189	7469	£2,185.00	£2,622.00	£2,731.25	£3,277.50	UP TO 5 WEEKS		
	1016	1350		5	22	ANCB5C22S	1131	3859	£1,360.00	£1,632.00	£1,700.00	£2,040.00	UP TO 5 WEEKS	
	1286	1650	28		ANCB5C28S	1439	4910	£1,502.00	£1,802.40	£1,877.50	£2,253.00	UP TO 5 WEEKS		
	1466	1650	32		ANCB5C32S	1645	5613	£1,638.00	£1,965.60	£2,047.50	£2,457.00	UP TO 5 WEEKS		
	1646	1950	36		ANCB5C36S	1850	6312	£1,734.00	£2,080.80	£2,167.50	£2,601.00	UP TO 5 WEEKS		
	1736	1950	38		ANCB5C38S	1953	6664	£1,836.00	£2,203.20	£2,295.00	£2,754.00	UP TO 5 WEEKS		
	2051	2150	45		ANCB5C45S	2313	7892	£2,082.00	£2,498.40	£2,602.50	£3,123.00	UP TO 5 WEEKS		
	2366	2650	52		ANCB5C52S	2673	9120	£2,354.00	£2,824.80	£2,942.50	£3,531.00	UP TO 5 WEEKS		
	1016	1350	6		22	ANCB6C22S	1335	4555	£1,448.00	£1,737.60	£1,810.00	£2,172.00	UP TO 5 WEEKS	
	1286	1650		28	ANCB6C28S	1700	5800	£1,615.00	£1,938.00	£2,018.75	£2,422.50	UP TO 5 WEEKS		
	1466	1650		32	ANCB6C32S	1942	6626	£1,764.00	£2,116.80	£2,205.00	£2,646.00	UP TO 5 WEEKS		
	1646	1950		36	ANCB6C36S	2185	7455	£1,879.00	£2,254.80	£2,348.75	£2,818.50	UP TO 5 WEEKS		
	1736	1950		38	ANCB6C38S	2307	7871	£1,985.00	£2,382.00	£2,481.25	£2,977.50	UP TO 5 WEEKS		
	2051	2150		45	ANCB6C45S	2732	9322	£2,335.00	£2,802.00	£2,918.75	£3,502.50	UP TO 5 WEEKS		
	2366	2650		52	ANCB6C52S	3156	10768	£2,633.00	£3,159.60	£3,291.25	£3,949.50	UP TO 5 WEEKS		

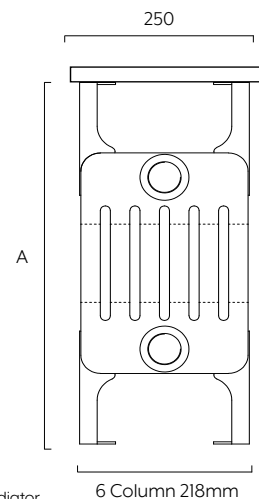
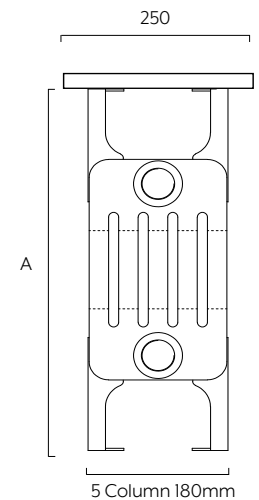
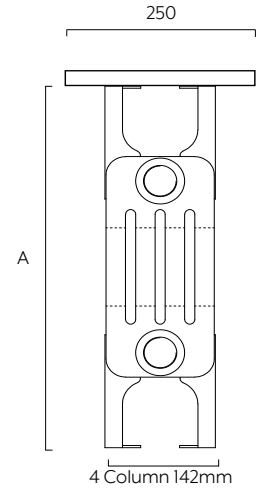

All prices shown include wooden seat. Please note height (A) does not include wooden seat.

Please note: Bench seats up to 1286mm wide will be supplied with 2 feet, 1466mm - 2366mm will be supplied with 4 feet

Pipe centres = width of radiator (B) + valves
Due to manufacturing tolerances widths may vary by +/- 2mm.

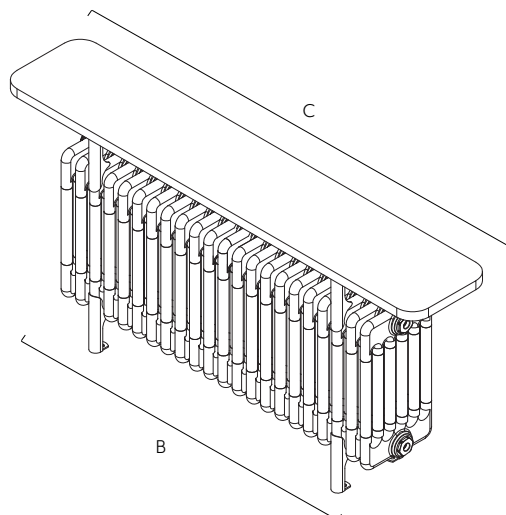
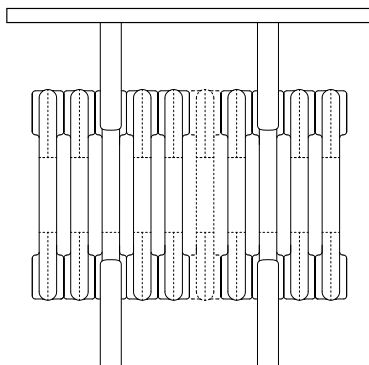

*Saving based on the value of individual items when bought separately. Order any of our selected valves & matching pipe covers at the same time as your radiator.

Ancona® Curved shown on page 28



High quality Italian design & manufacture

Steel Multi Column; 2, 3 & 4 column options with wall brackets or optional Welded Feet
CE/UKCA approved & certified to BS EN442.

White RAL 9016 as standard, 188 RAL colours, Bare Metal Lacquer & 31 Special Finishes.
Please call **01342 302250** for a RAL or Special Finish chart

Approximately 6-8 weeks from receipt of written sign off of technical drawings
Visit our website for further information theradiatorcompany.co.uk.



SAVE £45*
WHEN YOU BUY OUR VINTAGE TRV & PIPE COVERS WITH ANY ANCONA® PURCHASE QUOTING PROMOV2 AT TIME OF ORDER.

For all Vintage TRV finishes see page I22

Our Ancona® radiators can be curved to fit bay windows and around columns.

Alternative heights are available on request, please contact us on **01342 302250** if required. Radiators can be curved using up to 40 sections, minimum 10 sections (450mm).

As with all radiators, it is essential to know how much heat you need to keep your room comfortable. Use our online Heat Output Calculator to work out how much heat you will need for your room before you size your radiator.

Curving is a precise process and as such, accurate measurements and calculations must be made and checked before production can begin. Since our Ancona® Curved is made on a bespoke basis to your exact requirements, we have created an online tool to help make the process as easy as possible;

To order your curved radiator follow these simple steps;

- 1 Go to our website theradiatorcompany.co.uk and select the 'Curved Ancona®' in the column section, read the curved specification instructions which explains how to measure for your curved radiator
- 2 Select 'Buy Radiator' to use our online Curved Radiator Builder, please then fill in all sections.
- 3 When you have reviewed the technical specification, double-check everything is correct to see how your radiator will fit in your space
- 4 Print the technical specification pdf and sign all pages once you are happy with the details
- 5 Use the signed technical specification to place your order with your Installer / local merchant, the merchant will need to provide a copy of the signed drawing when placing the order.

Alternatively, provide the measurements to your installer/ merchant who can then place an order with us, we will create the drawings which you will need to check and sign off. However, additional time will be required for us to have drawings made and sent to you for approval, the order will remain on hold until the signed drawings are returned to us, we can then start the production process.

Please note; once you have signed off your drawings and ordered your curved radiator it cannot be cancelled or returned.

Ancona® Curved 2 column (output by section)

Height (mm)	Model	Watts Δt 50°C	Btu's Δt 50°C	White Ex VAT	White Inc VAT	Lacquer & Colours Ex VAT	Lacquer & Colours Inc VAT
DELIVERY TIMES		6-8 WEEKS FROM SIGN OFF					
300	ANCC2C30	23	78	£54.08	£64.90	£60.55	£72.66
400	ANCC2C40	30	102	£55.14	£66.17	£61.88	£74.26
500	ANCC2C50	36	123	£56.07	£67.28	£63.04	£75.65
600	ANCC2C60	43	147	£56.64	£67.97	£63.75	£76.50
750	ANCC2C75	52	177	£57.73	£69.28	£65.12	£78.14

Internal Ancona® Curved

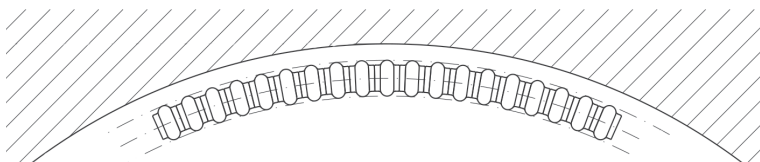

Ancona® Curved 3 column (output by section)

Height (mm)	Model	Watts Δt 50°C	Btu's Δt 50°C	White Ex VAT	White Inc VAT	Lacquer & Colours Ex VAT	Lacquer & Colours Inc VAT
DELIVERY TIMES		6-8 WEEKS FROM SIGN OFF					
300	ANCC3C30	32	109	£56.60	£67.92	£63.70	£76.44
400	ANCC3C40	42	143	£58.89	£70.67	£66.57	£79.88
500	ANCC3C50	51	174	£60.43	£72.52	£68.49	£82.19
600	ANCC3C60	60	205	£60.75	£72.90	£68.89	£82.67
750	ANCC3C75	74	252	£63.56	£76.27	£72.40	£86.88

Kits for Welded Feet

Note: Please remember to add 97mm to the height of the Ancona section you have chosen if you are using Welded Feet.

Sections	Model	No. of Feet	White Ex VAT	White Inc VAT	Lacquer & Colours Ex VAT	Lacquer & Colours Inc VAT
DELIVERY TIMES		6-8 WEEKS FROM SIGN OFF				
Up to 20 Sections	PPANCOWFKIT2	2	£122.00	£146.40	£152.50	£183.00
21-39 (odd number of sections)	PPANCOWFKIT3	3	£183.00	£219.60	£228.75	£274.50
22-40 (even number of sections)	PPANCOWFKIT4	4	£244.00	£292.80	£305.00	£366.00

Ancona® Curved 4 column (output by section)

Height (mm)	Model	Watts Δt 50°C	Btu's Δt 50°C	White Ex VAT	White Inc VAT	Lacquer & Colours Ex VAT	Lacquer & Colours Inc VAT
DELIVERY TIMES		6-8 WEEKS FROM SIGN OFF					
300	ANCC4C30	42	143	£60.31	£72.37	£68.34	£82.01
400	ANCC4C40	54	184	£61.93	£74.32	£70.37	£84.44
500	ANCC4C50	66	225	£64.40	£77.28	£73.45	£88.14
600	ANCC4C60	79	270	£67.50	£81.00	£77.33	£92.80
750	ANCC4C75	96	328	£68.52	£82.22	£78.60	£94.32

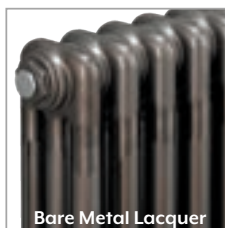

*Saving based on the value of individual items when bought separately.
Order any of our selected valves and matching pipe covers at the same time as your radiator.

Ancona[®] Electric shown on page 29

High quality Italian design & manufacture
 Steel Multi Column 3 column with wall brackets only
 Eco Design
 10 year guarantee on the radiator
 2 year guarantee on the element



White RAL 9016

Stock Sizes: 48-72 Hours

Made to Order Sizes: Up to 5 weeks

The Ancona electric ranges combine the classic Ancona design with the flexibility of a fully controllable electric element. Offering 8 function modes, the Ancona Electric can be set to operate when you wish, on a daily basis, or you can select one of the three pre-set programmes. The Open Window Function detects an open external door or window and will turn the radiator off if it detects that it is allowing heat to escape, saving energy and money.

Stock options White RAL 9016

Height (mm)	Width B (mm)	Sections	Model	Watts Δt 50°C	White Ex VAT	White Inc VAT
DELIVERY TIMES				48-72 HOURS		
600	708	14	ANCO3C6063EW	800	£887.00	£1,064.40
	843	17	ANCO3C6076EW	1000	£1,039.00	£1,246.80
	978	20	ANCO3C6090EW	1200	£1,190.00	£1,428.00
	1113	23	ANCO3C6010EW	1500	£1,341.00	£1,609.20



Made to order options

Height (mm)	Width B (mm)	Sections	Model	Watts Δt 50°C	White Ex VAT	White Inc VAT
DELIVERY TIMES				UP TO 5 WEEKS		
600	439	8	ANCO3C6036EW	400	£783.00	£939.60
	618	12	ANCO3C6054EW	600	£855.00	£1,026.00
	1383	29	ANCO3C6013EW	2000	£1,644.00	£1,972.80

- IP24
- 8 operating modes: weekly program, 3 integrated pre-set timed programs, pilot-wire facility, comfort, night and antifreeze.
- Open Window Function
- Comfort, Night and Antifreeze
- 2 Year Guarantee on the element

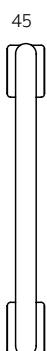
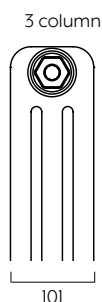

All sections 45mm wide

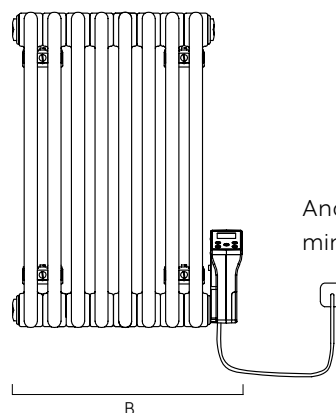

Ancona Electric radiators must be hung a minimum of 150mm off the floor

Relax Hybrid shown on page 32 New

High quality Italian design & manufacture.
Fan assisted radiator with a cooling option



Available in 5 colours: Matt White, Grey Skies, Grey Sparkle, Carbon & Sand.
Optional LED lighting system. Touch display on side of radiator, Insulation Class I
Horizontal models are configurable with right or left connections, please specify at time of order.

Delivered in up to 7 weeks



Innovative heating and cooling combination, with a fan coil assisted radiator and cooling functions.

Heats in winter and with appropriate system specification acts as a cooling unit in summer.

- Available in 2 heights; 650 and 1800mm
- 4 widths; 630, 920, 1120 and 1320mm
- Slimline contemporary design
- 3 operating modes (see below)
- Horizontal models are configurable with right or left connections.
- Choice of 5 colours (see below)
- LED lighting system (optional).

The onboard control panel, allows you to set your required room temperature, season (summer or winter), and the operation mode:

Automatic Mode; auto-regulation of the fan speed from a minimum value to maximum, to achieve the required temperature.

Night Mode; fan speed is reduced to guarantee quiet operation & comfort.

Boost Mode; gives maximum available power immediately, in both heating and cooling modes. As the room temperature reaches the required value, the fan speed is automatically reduced to save energy.

To work as an air cooler the Relax Hybrid should be connected to a system powered by a heat pump, and which has been designed to manage the circulation of cold water.

When operating in air cooling mode, the Relax Hybrid automatically isolates the heating components to prevent the formation of condensation.

For correct installation, it is essential for the system to have, a hot/insulated cold water supply, an electric connection and a facility to drain off condensation when operating in air cooling mode.

When installed in a traditional system with a boiler, the Relax Hybrid guarantees maximum heating efficiency, thanks to its hybrid operation utilising both radiant heat and fan assisted air movement. This method, quickly reaches and maintains the ideal temperature throughout the room.



Relax Hybrid Finishes

Please call customer services for sample swatches.

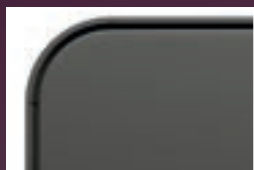

Grey Sparkle

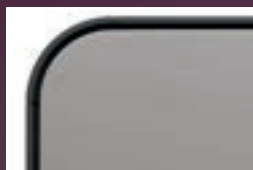

Grey Skies



Carbon



Matt White



Sand

Relax Hybrid shown on page 32 New

High quality Italian design & manufacture.
Fan assisted radiator with a cooling option



Available in 5 colours: Matt White, Grey Skies, Grey Sparkle, Carbon & Sand.
Optional LED lighting system. Touch display on side of radiator, Insulation Class I
Horizontal models are configurable with right or left connections, please specify at time of order.

Delivered in up to 7 weeks



Pipe centres left to right	Depth from wall
50mm	107

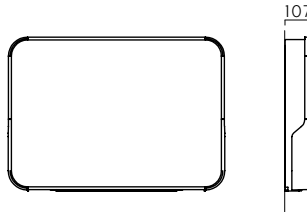

Horizontal Made to order options -without LED

Height (mm)	Width (mm)	Model	Watts Δt 50°C	Btu's Δt 50°C	Watts Δt 50°C	Btu's Δt 50°C	Watts Δt 50°C	Btu's Δt 50°C	Colours Ex VAT	Colours Inc VAT
			NIGHT MODE		AUTO MODE		BOOST MODE		UP TO 7 WEEKS	
650	920	REHYH6592	1403	4787	2394	8168	2675	9127	£1,541.00	£1,849.20
	1120	REHYH6511	1547	5278	2701	9216	3154	10761	£1,703.00	£2,043.60
	1320	REHYH6513	2028	6920	3529	12041	3946	13464	£1,865.00	£2,238.00

Horizontal Made to order options -with LED

Height (mm)	Width (mm)	Model	Watts Δt 50°C	Btu's Δt 50°C	Watts Δt 50°C	Btu's Δt 50°C	Watts Δt 50°C	Btu's Δt 50°C	Colours Ex VAT	Colours Inc VAT
			NIGHT MODE		AUTO MODE		BOOST MODE		UP TO 7 WEEKS	
650	920	REHYLEDH6592	1403	4787	2394	8168	2675	9127	£1,784.00	£2,140.80
	1120	REHYLEDH6511	1547	5278	2701	9216	3154	10761	£1,946.00	£2,335.20
	1320	REHYLEDH6513	2028	6920	3529	12041	3946	13464	£2,108.00	£2,529.60

Please specify right or left handed at time of order.

Sound Data**	Horizontal 650 x 920			Horizontal 650 x 1120			Horizontal 650 x 1320		
	NIGHT MODE	AUTO MODE	BOOST MODE	NIGHT MODE	AUTO MODE	BOOST MODE	NIGHT MODE	AUTO MODE	BOOST MODE
Sound Power dB(A)	34,4	52,1	56,3	34,0	51,2	55,6	33,9	51,3	55,8
Sound pressure (2 m) dB(A)	20,8	36,4	40,4	20,3	35,5	39,9	18,7	34,9	39,3

Vertical Made to order options -without LED

Height (mm)	Width (mm)	Model	Watts Δt 50°C	Btu's Δt 50°C	Watts Δt 50°C	Btu's Δt 50°C	Watts Δt 50°C	Btu's Δt 50°C	Colours Ex VAT	Colours Inc VAT
			NIGHT MODE		AUTO MODE		BOOST MODE		UP TO 7 WEEKS	
1800	630	REHYV1863	1636	5582	2758	9410	3093	10553	£2,189.00	£2,626.80

Vertical Made to order options -with LED

Height (mm)	Width (mm)	Model	Watts Δt 50°C	Btu's Δt 50°C	Watts Δt 50°C	Btu's Δt 50°C	Watts Δt 50°C	Btu's Δt 50°C	Colours Ex VAT	Colours Inc VAT
			NIGHT MODE		AUTO MODE		BOOST MODE		UP TO 7 WEEKS	
1800	630	REHYLEDV1863	1636	5582	2758	9410	3093	10553	£2,433.00	£2,919.60

Sound Data**	Vertical 1800 x 630		
	NIGHT MODE	AUTO MODE	BOOST MODE
Sound Power dB(A)	33,7	51,7	56,0
Sound pressure (2 m) dB(A)	19,7	34,5	38,8

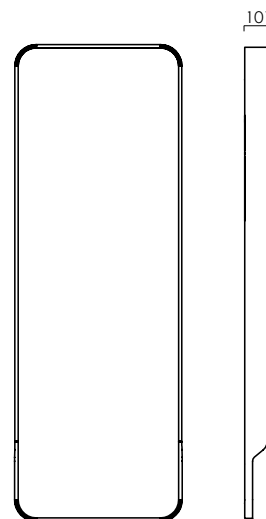

Vertical front view drawing



Water supply for right-hand option (front view)



Water supply for left-hand option (front view)



Key:

- Pipe centres 50mm
- Condensation drainage tray
- Electric unit
- Touch display

Key:

- Pipe centres 50mm
- Condensation drainage tray
- Electric unit
- Touch display

Piano & Sax Electric shown on pages 34 & 35



High quality Italian design & manufacture. **Can be hung horizontally or vertically.**

Piano Electric: Steel; 50mm flat tubes with optional LEDs

Sax Electric: Steel; 20mm x 25mm tubes with optional LEDs

Eco Design. 10 year guarantee on radiators. 2 year guarantee on elements.

WiFi electronic control. Insulation class II, protection rating IP24

White RAL 9016 as standard, 188 RAL colours plus 31 Special Finishes

Please call **01342 302250** for a RAL or Special Finish chart.

Stock White RAL 9016: 48-72 Hours

Made to Order sizes & colours: Up to 7 weeks.



Please Note: The operation of any Smart Electric Radiator strictly depends on the success of the pairing via the App (and connection will be needed via a WiFi network).

Piano Electric Stock Vertical or Horizontal - without LED

Height (mm)	Width (mm)	Model	Watts Δt 50°C	White Ex VAT	White Inc VAT	Colours Ex VAT	Colours Inc VAT
DELIVERY TIMES				48-72 HOURS		UP TO 7 WEEKS	
900	667	PIAN9066E	750	£1,061.00	£1,273.20	£1,167.00	£1,400.40
1800	667	PIAN1866E	1500	£1,212.00	£1,454.40	£1,333.00	£1,599.60

Piano Electric Made to order options vertical or horizontal - without LED

Height (mm)	Width (mm)	Model	Watts Δt 50°C	White Ex VAT	White Inc VAT	Colours Ex VAT	Colours Inc VAT
DELIVERY TIMES				UP TO 7 WEEKS		UP TO 7 WEEKS	
900	443	PIAN9044E	500	£1,018.00	£1,221.60	£1,120.00	£1,344.00
1800	443	PIAN1844E	1000	£1,121.00	£1,345.20	£1,233.00	£1,479.60
1800	891	PIAN1889E	1800	£1,314.00	£1,576.80	£1,445.00	£1,734.00

Piano Electric Made to order options vertical or horizontal - with LED

Height (mm)	Width (mm)	Model	Watts Δt 50°C	White Ex VAT	White Inc VAT	Colours Ex VAT	Colours Inc VAT
DELIVERY TIMES				UP TO 7 WEEKS		UP TO 7 WEEKS	
900	443	PIANLED9044E	500	£1,828.00	£2,193.60	£1,930.16	£2,316.19
900	667	PIANLED9066E	750	£1,871.00	£2,245.20	£1,977.16	£2,372.59
1800	443	PIANLED1844E	1000	£1,931.00	£2,317.20	£2,043.16	£2,451.79
1800	667	PIANLED1866E	1500	£2,022.00	£2,426.40	£2,143.16	£2,571.79
1800	891	PIANLED1889E	1800	£2,124.00	£2,548.80	£2,255.16	£2,706.19

These radiators can be hung horizontally or vertically, if hung horizontally the element must be located at the bottom of the radiator as shown in the drawings & pictures below.

Piano Electric hung horizontally

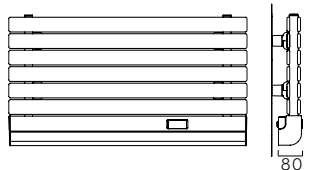

Piano Electric hung vertically

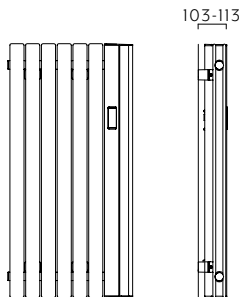

Depth from wall

103mm - 113mm

Please Note: The operation of any Smart Electric Radiator strictly depends on the success of the pairing via the App (and connection will be needed via a WiFi network).

Sax Electric Stock Vertical or Horizontal - without LED

Height (mm)	Width (mm)	Model	Watts Δt 50°C	White Ex VAT	White Inc VAT	Colours Ex VAT	Colours Inc VAT
DELIVERY TIMES				48-72 HOURS		UP TO 7 WEEKS	
900	575	SAX9057E	750	£1,061.00	£1,273.20	£1,167.00	£1,400.40
1800	575	SAX1857E	1500	£1,188.00	£1,425.60	£1,307.00	£1,568.40

Sax Electric Made to order options vertical or horizontal - without LED

Height (mm)	Width (mm)	Model	Watts Δt 50°C	White Ex VAT	White Inc VAT	Colours Ex VAT	Colours Inc VAT
DELIVERY TIMES				UP TO 7 WEEKS		UP TO 7 WEEKS	
900	415	SAX9041E	500	£1,034.00	£1,240.80	£1,137.00	£1,364.40
1800	415	SAX1841E	1000	£1,127.00	£1,352.40	£1,240.00	£1,488.00
1800	735	SAX1873E	1800	£1,235.00	£1,482.00	£1,359.00	£1,630.80

Sax Electric Made to order options vertical or horizontal - with LED

Height (mm)	Width (mm)	Model	Watts Δt 50°C	White Ex VAT	White Inc VAT	Colours Ex VAT	Colours Inc VAT
DELIVERY TIMES				UP TO 7 WEEKS		UP TO 7 WEEKS	
900	415	SAXLED9041E	500	£1,844.00	£2,212.80	£1,947.16	£2,336.59
900	575	SAXLED9057E	750	£1,871.00	£2,245.20	£1,977.16	£2,372.59
1800	415	SAXLED1841E	1000	£1,937.00	£2,324.40	£2,050.16	£2,460.19
1800	575	SAXLED1857E	1500	£1,998.00	£2,397.60	£2,117.16	£2,540.59
1800	735	SAXLED1873E	1800	£2,045.00	£2,454.00	£2,169.16	£2,602.99

These radiators can be hung horizontally or vertically, if hung horizontally the element must be located at the bottom of the radiator as shown in the drawings & pictures below.

Sax Electric hung horizontally

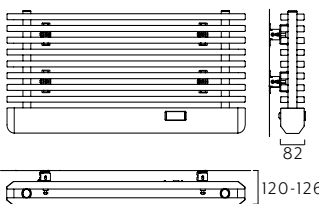

Sax Electric hung vertically

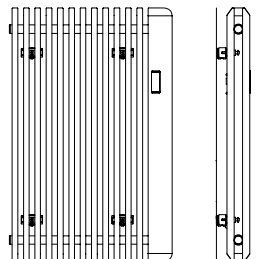

Depth from wall

120mm - 126mm

Polygon shown on page 33 New

High quality Italian design & manufacture.
 Eco Design. Electric heating element with WiFi electronic control
 Multicolour LED lighting system with adjustable intensity
 Insulation class II, protection rating IP24
 10 year guarantee on radiators. 2 year guarantee on elements.



White RAL 9016 as standard, 188 RAL colours, 31 Special Finishes plus 3 two-tone colour options (shown below). Please call **01342 302250** for a RAL or Special Finish chart.

Made to Order sizes & colours: Up to 7 weeks.

Please Note: The operation of any Smart Electric Radiator strictly depends on the success of the pairing via the App (and connection will be needed via a WiFi network). Once the radiator is connected to the app, the WiFi can be switched off, and the radiator can be used manually via the keypad.

The Polygon electric radiator is equipped with a WiFi control system that interacts with the IRSAP NOW App, compatible with Google Home and Amazon Alexa, which allows you to set and manage the temperature control in each individual room. Using sensors, an electronic check valve and a dedicated app, it will be possible to set up your system your smartphone. Once the first connection has been made, it's possible to control and customise heating straight from your smartphone, even remotely.



Made to order options - Horizontal

Height (mm)	Width (mm)	Model	Watts Δt 50°C	White Ex VAT	White Inc VAT	Colours Ex VAT	Colours Inc VAT	Two-Tone Ex VAT	Two-Tone Inc VAT
DELIVERY TIMES				UP TO 7 WEEKS		UP TO 7 WEEKS		UP TO 7 WEEKS	
500	1800	POLYLED5018E	750	£3,662.00	£4,394.40	£4,028.00	£4,833.60	£4,028.00	£4,833.60

Polygon Horizontal	Depth from wall
Polygon Horizontal	224mm -229mm

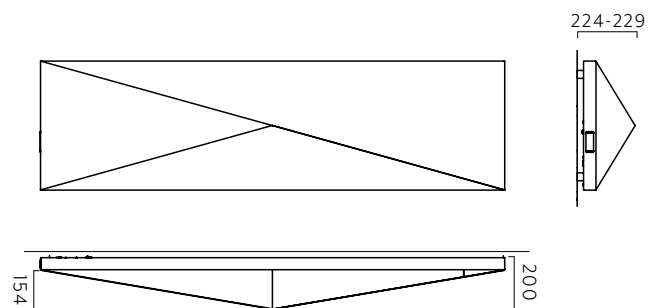

Made to order options - Vertical

Height (mm)	Width (mm)	Model	Watts Δt 50°C	White Ex VAT	White Inc VAT	Colours Ex VAT	Colours Inc VAT	Two-Tone Ex VAT	Two-Tone Inc VAT
DELIVERY TIMES				UP TO 7 WEEKS		UP TO 7 WEEKS		UP TO 7 WEEKS	
1800	500	POLYLED1850E	750	£3,662.00	£4,394.40	£4,028.00	£4,833.60	£4,028.00	£4,833.60

Polygon Vertical	Depth from wall
Polygon Vertical	144mm - 149mm

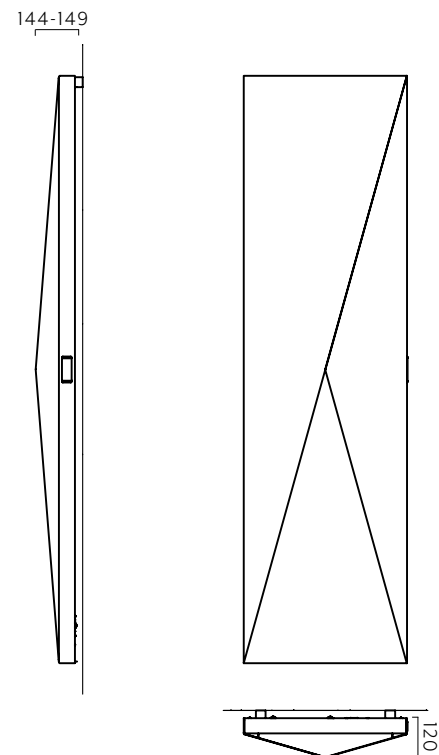

Two-tone options (please specify your chosen combination at time of order)



Ceramica Collection shown on pages 36-37

High quality Italian design & manufacture.

Recycled Marble radiant panels

Hydronic or Electric versions available

White finish only; choose from 3 different models - Varenna, Pavia or Senso
All hydronic versions come complete with our 'hidden valve' system including
thermostatic valves and flexi hoses

Electric versions; Class II IPX24 with fully programmable digital control

Delivered in up to 6 weeks



Pipe centres	Depth from wall
Pipes come directly out of the wall, 60mm apart.	74mm

Made to order options - Hydronic Vertical

Height (mm)	Width (mm)	Model	Watts Δt 50°C	Btu's Δt 50°C	White Ex VAT	White Inc VAT
DELIVERY TIMES			UP TO 6 WEEKS			
1100	550	CERAVI155	720	2457	£1,809.00	£2,170.80
1500	550	CERAVI555	1200	4094	£2,045.00	£2,454.00
1800	300	CERAVI830	480	1638	£1,792.00	£2,150.40
	550	CERAVI855	1680	5732	£2,187.00	£2,624.40

Please make sure you specify your model at time of order;
Senso, Varenna or Pavia (shown right)

Made to order options - Hydronic Horizontal

Height (mm)	Width (mm)	Model	Watts Δt 50°C	Btu's Δt 50°C	White Ex VAT	White Inc VAT
DELIVERY TIMES			UP TO 6 WEEKS			
550	860	CERAH5586	600	2047	£1,738.00	£2,085.60
	1100	CERAH5511	720	2457	£1,870.00	£2,244.00

Please make sure you specify your model at time of order; Senso, Varenna or Pavia

- Senso - simple and plain, a lightly textured effect creating a subtle statement.
- Varenna- a sense of movement created by the interaction of light and shade across the soft lines and gentle curves of the design.
- Pavia - a natural stone effect finish with a strong bold impact.

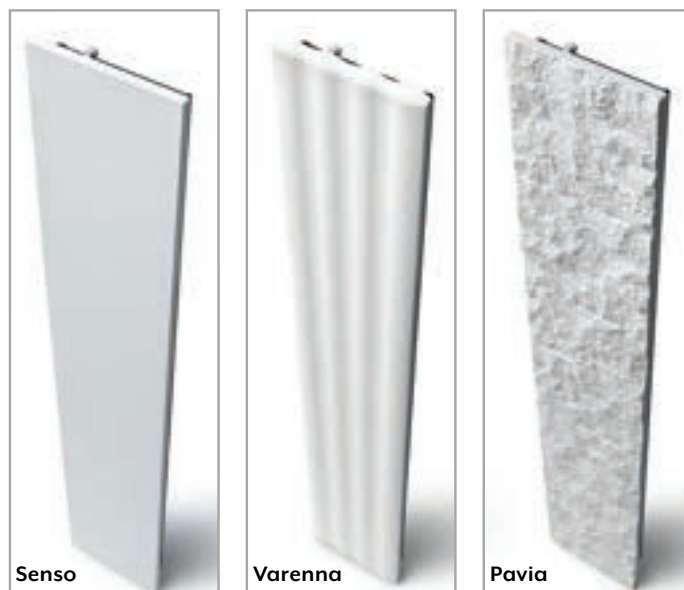

Please Note: These radiators are very heavy and will require at least two people to lift and fit.

Made to order options - Electric Vertical

Height (mm)	Width (mm)	Model	Watts Δt 50°C	White Ex VAT	White Inc VAT
DELIVERY TIMES			UP TO 6 WEEKS		
1000	300	CERAVI030E	250	£1,485.00	£1,782.00
1100	550	CERAVI155E	750	£1,616.00	£1,939.20
1500	550	CERAVI555E	1000	£1,819.00	£2,182.80
1800	300	CERAVI830E	500	£1,600.00	£1,920.00
	550	CERAVI855E	1400	£1,932.00	£2,318.40

Please make sure you specify your model at time of order;
Senso, Varenna or Pavia

Made to order options - Electric Horizontal

Height (mm)	Width (mm)	Model	Watts Δt 50°C	White Ex VAT	White Inc VAT
DELIVERY TIMES			UP TO 6 WEEKS		
550	860	CERAH5586E	500	£1,616.00	£1,939.20
	1100	CERAH5511E	750	£1,706.00	£2,047.20

Please make sure you specify your model at time of order;
Senso, Varenna or Pavia

Please Note: These radiators are very heavy and will require at least two people to lift and fit.

Tested following the European standards and certified by qualified bodies.

Electric safety
EN 60335-1, 2-30
EN 62233

Electromagnetic compatibility
EN 55014-1, -2
EN 61000-3-2, 3-3



Class II Electric Radiators come with a fully programmable digital display on the side of the radiator that operates a thermostat offering standard settings such as frost protection, comfort mode, eco mode, auto mode, and boost mode.

Torré shown on pages 38-39



High quality Italian design & manufacture.
Ultra slimline extruded Aluminium profile with a curved edge
CE/UKCA approved & certified to BS EN442.

Textured Matt White as standard, 23 RAL colours & 31 Special Finishes.
Please call **01342 302250** for a RAL or Special Finish chart.
6 NEW Feature Finishes, see page 7 or call **01342 302250** for samples.
Colour Coordination Service available see page 217 for full details.

Stock Textured Matt White: 48-72 Hours. All Colours & Finishes: Up to 2 weeks.

Pipe centres left to right	Pipe centres from wall	Depth from wall
width + valves	65mm	96mm

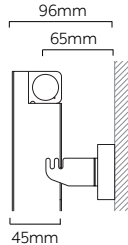

Stock options Textured Matt White - Horizontal

Please add 10% to the RAL/Special Finish price to work out your Feature Finish price

Height (mm)	Width (mm)	Model	Watts $\Delta t 50^\circ C$	Btu's $\Delta t 50^\circ C$	White Ex VAT	White Inc VAT	RALs & Special Finishes	
							Ex VAT	Inc VAT
DELIVERY TIMES							48-72 HOURS	UP TO 2 WEEKS
500	956	TORR509508H	877	2992	£702.00	£842.40	£877.50	£1,053.00
	1196	TORR501110H	1097	3743	£877.00	£1,052.40	£1,096.25	£1,315.50
	1436	TORR501412H	1316	4490	£1,056.00	£1,267.20	£1,320.00	£1,584.00
600	956	TORR609508H	1007	3436	£740.00	£888.00	£925.00	£1,110.00
	1196	TORR601110H	1259	4296	£928.00	£1,113.60	£1,160.00	£1,392.00
	1436	TORR601412H	1510	5152	£1,115.00	£1,338.00	£1,393.75	£1,672.50

23 RAL colours are shown on page 216, 6 New feature finishes shown on page 7.



Ideal TRV & Pipe Covers

SAVE £45*
WHEN YOU BUY OUR IDEAL TRV & PIPE COVERS WITH ANY DESIGNER PURCHASE. QUOTE PROMОВI AT TIME OF ORDER.

Available in White or Chrome.

*Saving based on the value of individual items when bought separately. Order any of our selected valves & matching pipe covers at the same time as your radiator, PROMОВIW (white), PROMОВIC (chrome).

Stock options Textured Matt White - Vertical

Please add 10% to the RAL/Special Finish price to work out your Feature Finish price

Height (mm)	Width (mm)	Model	Watts $\Delta t 50^\circ C$	Btu's $\Delta t 50^\circ C$	White Ex VAT	White Inc VAT	RALs & Special Finishes	
							Ex VAT	Inc VAT
DELIVERY TIMES							48-72 HOURS	UP TO 2 WEEKS
1500	356	TORR153503V	784	2675	£538.00	£645.60	£672.50	£807.00
	476	TORR154704V	1045	3566	£718.00	£861.60	£897.50	£1,077.00
	596	TORR155905V	1306	4456	£897.00	£1,076.40	£1,121.25	£1,345.50
1800	356	TORR183503V	911	3108	£568.00	£681.60	£710.00	£852.00
	476	TORR184704V	1265	4316	£755.00	£906.00	£943.75	£1,132.50
	596	TORR185905V	1527	5210	£942.00	£1,130.40	£1,177.50	£1,413.00

23 RAL colours are shown on page 216, 6 New feature finishes shown on page 7.

Niro shown on pages 40-41

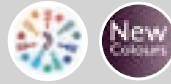

High quality Italian design & manufacture.
Ultra slimline extruded Aluminium profile
CE/UKCA approved & certified to BS EN442.

Textured Matt White RAL 9016 as standard, 23 RAL colours & 31 Special Finishes.
Please call **01342 302250** for a RAL or Special Finish chart.
6 NEW Feature Finishes, see page 7 or call **01342 302250** for samples.
Colour Coordination Service available see page 217 for full details.

Stock Textured Matt White: 48-72 Hours. All Colours & Finishes: Up to 2 weeks.

Pipe centres left to right	Pipe centres from wall	Depth from wall
width + valves	59mm	77mm

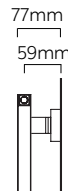

Stock options Textured Matt White - Horizontal

Please add 10% to the RAL/Special Finish price to work out your Feature Finish price

Height (mm)	Width (mm)	Model	Watts $\Delta t 50^\circ C$	Btu's $\Delta t 50^\circ C$	White Ex VAT	White Inc VAT	RALs & Special Finishes	
							Ex VAT	Inc VAT
DELIVERY TIMES							48-72 HOURS	UP TO 2 WEEKS
631	799	NIROH637910	710	2423	£770.00	£924.00	£924.00	£1,108.80
	1039	NIROH631013	923	3149	£1,001.00	£1,201.20	£1,201.20	£1,441.44
	1199	NIROH631115	1065	3634	£1,155.00	£1,386.00	£1,386.00	£1,663.20

23 RAL colours are shown on page 216, 6 New feature finishes shown on page 7.



Ideal TRV & Pipe Covers

SAVE £45*
WHEN YOU BUY OUR IDEAL TRV & PIPE COVERS WITH ANY DESIGNER PURCHASE. QUOTE PROMОВI AT TIME OF ORDER.

Available in White or Chrome.

*Saving based on the value of individual items when bought separately. Order any of our selected valves & matching pipe covers at the same time as your radiator, PROMОВIW (white), PROMОВIC (chrome).

Stock options Textured Matt White - Vertical

Please add 10% to the RAL/Special Finish price to work out your Feature Finish price

Height (mm)	Width (mm)	Model	Watts $\Delta t 50^\circ C$	Btu's $\Delta t 50^\circ C$	White Ex VAT	White Inc VAT	RALs & Special Finishes	
							Ex VAT	Inc VAT
DELIVERY TIMES							48-72 HOURS	UP TO 2 WEEKS
1831	399	NIROV183905	940	3207	£648.00	£777.60	£777.60	£933.12
	479	NIROV184706	1127	3845	£778.00	£933.60	£933.60	£1,120.32
	559	NIROV185507	1315	4487	£906.00	£1,087.20	£1,087.20	£1,304.64

23 RAL colours are shown on page 216, 6 New feature finishes shown on page 7.

Iseo shown on pages 42-43

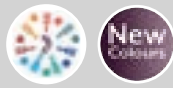

High quality Italian design & manufacture.
85mm extruded Aluminium tubes with a curved edge
CE/UKCA approved & certified to BS EN442.

Textured Matt White as standard, 23 RAL colours & 31 Special Finishes.
Please call **01342 302250** for a RAL or Special Finish chart.
6 NEW Feature Finishes, see page 7 or call **01342 302250** for samples.
Colour Coordination Service available see page 217 for full details.

Stock Textured Matt White: 48-72 Hours. All Colours & Finishes: Up to 2 weeks.

Ideal TRV & Pipe Covers 

SAVE £45*
WHEN YOU BUY OUR IDEAL TRV & PIPE COVERS WITH ANY DESIGNER PURCHASE. QUOTE **PROMOVI** AT TIME OF ORDER.

Available in White or Chrome.

Pipe centres left to right	Pipe centres from wall	Depth from wall
width + valves	36mm - 46mm	111mm - 121mm

Stock options Textured Matt White - Horizontal

Please add 10% to the RAL/Special Finish price to work out your Feature Finish price

Height (mm)	Width (mm)	Model	Watts Δt 50°C	Btu's Δt 50°C	White Ex VAT	White Inc VAT	RALs & Special Finishes Ex VAT	RALs & Special Finishes Inc VAT
DELIVERY TIMES					48-72 HOURS		UP TO 2 WEEKS	
500	845	ISEOH508410	928	3166	£811.00	£973.20	£973.20	£1,167.84
	1015	ISEOH501012	1114	3801	£972.00	£1,166.40	£1,166.40	£1,399.68
	1185	ISEOH501114	1299	4432	£1,134.00	£1,360.80	£1,360.80	£1,632.96
	1440	ISEOH501417	1578	5384	£1,377.00	£1,652.40	£1,652.40	£1,982.88

23 RAL colours are shown on page 216

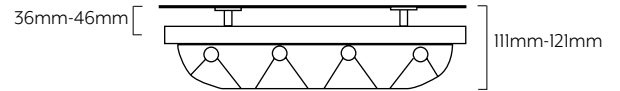

Stock options Textured Matt White - Vertical

Please add 10% to the RAL/Special Finish price to work out your Feature Finish price

Height (mm)	Width (mm)	Model	Watts Δt 50°C	Btu's Δt 50°C	White Ex VAT	White Inc VAT	RALs & Special Finishes Ex VAT	RALs & Special Finishes Inc VAT
DELIVERY TIMES					48-72 HOURS		UP TO 2 WEEKS	
1800	335	ISEOV183304	977	3334	£583.00	£699.60	£699.60	£839.52
	420	ISEOV184205	1222	4169	£729.00	£874.80	£874.80	£1,049.76
	505	ISEOV185006	1466	5002	£876.00	£1,051.20	£1,051.20	£1,261.44
	590	ISEOV185907	1710	5835	£1,021.00	£1,225.20	£1,225.20	£1,470.24

23 RAL colours are shown on page 216

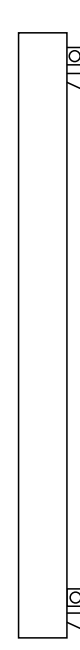

Feature Finishes

See page 7 for more information or call customer services for sample swatches.

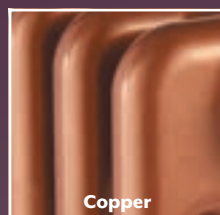
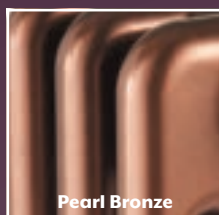
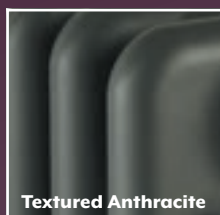
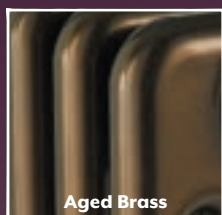

To work out your Feature Finish price please add 10% to the RAL/Special Finish colour price shown in the above tables.

*Saving based on the value of individual items when bought separately. Order any of our selected valves & matching pipe covers at the same time as your radiator; PROMOVIW (white), PROMOVIC (chrome).

Sebino shown on pages 44-45

High quality Italian design & manufacture.
82mm sections Aluminium radiator
CE/UKCA approved & certified to BS EN442.

White RAL 9010 and Matt Silver.

Stock White RAL 9010: 48-72 Hours

Made to order sizes: Up to 7 weeks White RAL 9010
Up to 9 weeks Matt Silver.



Pipe centres left to right	Pipe centres from wall	Depth from wall
width + valves	50mm	80mm

SAVE £45*
WHEN YOU BUY OUR IDEAL TRV & PIPE COVERS WITH ANY DESIGNER PURCHASE. QUOTE PROMOV1 AT TIME OF ORDER.

Available in White or Chrome.

Stock options White RAL 9010 - Horizontal

Height (mm)	Width (mm)	Model	Watts Δt 50°C	Btu's Δt 50°C	White Ex VAT	White Inc VAT	Matt Silver Ex VAT	Matt Silver Inc VAT
DELIVERY TIMES					48-72 HOURS		UP TO 9 WEEKS	
634	820	SEBISH638210	995	3395	£695.00	£834.00	£903.50	£1,084.20
	980	SEBISH639812	1194	4074	£824.00	£988.80	£1,071.20	£1,285.44
	1140	SEBISH631114	1393	4753	£938.00	£1,125.60	£1,219.40	£1,463.28

Stock options White RAL 9010 - Vertical

Height (mm)	Width (mm)	Model	Watts Δt 50°C	Btu's Δt 50°C	White Ex VAT	White Inc VAT	Matt Silver Ex VAT	Matt Silver Inc VAT
DELIVERY TIMES					48-72 HOURS		UP TO 9 WEEKS	
1834	340	SEBISVI83404	929	3170	£671.00	£805.20	£872.30	£1,046.76
	500	SEBISVI85006	1394	4756	£909.00	£1,090.80	£1,181.70	£1,418.04
	660	SEBISVI86608	1858	6339	£1,149.00	£1,378.80	£1,493.70	£1,792.44

Made to order options - Horizontal

Height (mm)	Width (mm)	Model	Watts Δt 50°C	Btu's Δt 50°C	White Ex VAT	White Inc VAT	Matt Silver Ex VAT	Matt Silver Inc VAT
DELIVERY TIMES					UP TO 7 WEEKS		UP TO 9 WEEKS	
384	500	SEBISH385006	392	1338	£395.00	£474.00	£513.50	£616.20
	660	SEBISH386608	523	1784	£493.00	£591.60	£640.90	£769.08
	820	SEBISH388210	654	2231	£591.00	£709.20	£768.30	£921.96
	980	SEBISH389812	785	2678	£695.00	£834.00	£903.50	£1,084.20
	1140	SEBISH381114	916	3125	£794.00	£952.80	£1,032.20	£1,238.64
534	500	SEBISH535006	518	1767	£434.00	£520.80	£564.20	£677.04
	660	SEBISH536608	690	2354	£546.00	£655.20	£709.80	£851.76
	820	SEBISH538210	863	2945	£656.00	£787.20	£852.80	£1,023.36
	980	SEBISH539812	1036	3535	£774.00	£928.80	£1,006.20	£1,207.44
	1140	SEBISH531114	1208	4122	£883.00	£1,059.60	£1,147.90	£1,377.48
634	500	SEBISH635006	597	2037	£464.00	£556.80	£603.20	£723.84
	660	SEBISH636608	796	2716	£582.00	£698.40	£756.60	£907.92
734	500	SEBISH735006	674	2300	£487.00	£584.40	£633.10	£759.72
	660	SEBISH736608	898	3064	£615.00	£738.00	£799.50	£959.40
	820	SEBISH738210	1123	3832	£745.00	£894.00	£968.50	£1,162.20
	980	SEBISH739812	1348	4599	£870.00	£1,044.00	£1,131.00	£1,357.20
	1140	SEBISH731114	1572	5364	£1,001.00	£1,201.20	£1,301.30	£1,561.56
834	500	SEBISH835006	748	2552	£513.00	£615.60	£666.90	£800.28
	660	SEBISH836608	998	3405	£651.00	£781.20	£846.30	£1,015.56
	820	SEBISH838210	1247	4255	£789.00	£946.80	£1,025.70	£1,230.84
	980	SEBISH839812	1496	5104	£926.00	£1,111.20	£1,203.80	£1,444.56
	1140	SEBISH831114	1746	5957	£1,056.00	£1,267.20	£1,372.80	£1,647.36
934	500	SEBISH935006	821	2801	£635.00	£762.00	£825.50	£990.60
	660	SEBISH936608	1094	3733	£789.00	£946.80	£1,025.70	£1,230.84
	820	SEBISH938210	1368	4668	£948.00	£1,137.60	£1,232.40	£1,478.88
	980	SEBISH939812	1642	5603	£1,096.00	£1,315.20	£1,424.80	£1,709.76
	1140	SEBISH931114	1915	6534	£1,248.00	£1,497.60	£1,622.40	£1,946.88
1034	500	SEBISH105006	890	3037	£686.00	£823.20	£891.80	£1,070.16
	660	SEBISH106608	1187	4050	£858.00	£1,029.60	£1,115.40	£1,338.48
	820	SEBISH108210	1484	5063	£1,027.00	£1,232.40	£1,335.10	£1,602.12
	980	SEBISH109812	1781	6077	£1,185.00	£1,422.00	£1,540.50	£1,848.60
	1140	SEBISH101114	2078	7090	£1,352.00	£1,622.40	£1,757.60	£2,109.12

Made to order options - Vertical

Height (mm)	Width (mm)	Model	Watts Δt 50°C	Btu's Δt 50°C	White Ex VAT	White Inc VAT	Matt Silver Ex VAT	Matt Silver Inc VAT
DELIVERY TIMES					UP TO 7 WEEKS		UP TO 9 WEEKS	
1234	340	SEBISVI23404	684	2334	£557.00	£668.40	£724.10	£868.92
	500	SEBISVI25006	1025	3497	£740.00	£888.00	£962.00	£1,154.40
	660	SEBISVI26608	1367	4664	£929.00	£1,114.80	£1,207.70	£1,449.24
	820	SEBISVI28210	1709	5831	£1,115.00	£1,338.00	£1,449.50	£1,739.40
1434	340	SEBISVI43404	769	2624	£596.00	£715.20	£774.80	£929.76
	500	SEBISVI45006	1154	3937	£804.00	£964.80	£1,045.20	£1,254.24
	660	SEBISVI46608	1538	5248	£1,002.00	£1,202.40	£1,302.60	£1,563.12
	820	SEBISVI48210	1923	6561	£1,210.00	£1,452.00	£1,573.00	£1,887.60
1634	340	SEBISVI63404	851	2904	£637.00	£764.40	£828.10	£993.72
	500	SEBISVI65006	1277	4357	£858.00	£1,029.60	£1,115.40	£1,338.48
	660	SEBISVI66608	1702	5807	£1,080.00	£1,296.00	£1,404.00	£1,684.80
1834	820	SEBISVI68210	2128	7261	£1,293.00	£1,551.60	£1,680.90	£2,017.08
2034	820	SEBISVI88210	2323	7926	£1,382.00	£1,658.40	£1,796.60	£2,155.92
	340	SEBISVI203404	1004	3426	£710.00	£852.00	£923.00	£1,107.60
	500	SEBISVI205006	1507	5142	£972.00	£1,166.40	£1,263.60	£1,516.32
	660	SEBISVI206608	2009	6855	£1,224.00	£1,468.80	£1,591.20	£1,909.44
820	SEBISVI208210	2511	8568	£1,475.00	£1,770.00	£1,917.50	£2,301.00	

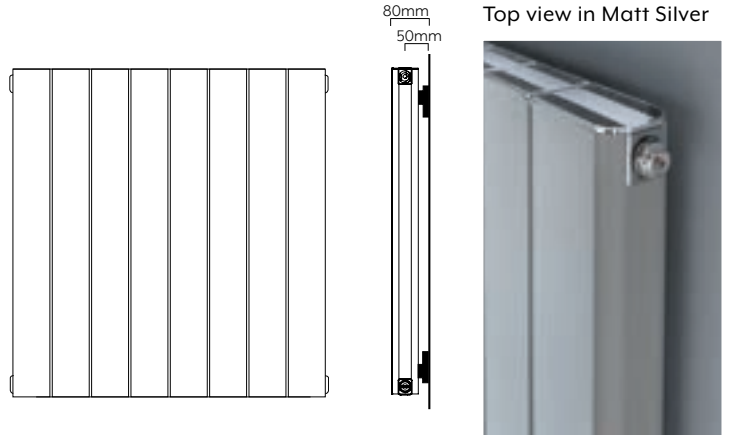

*Saving based on the value of individual items when bought separately. Order any of our selected valves & matching pipe covers at the same time as your radiator; PROMOVIV (white), PROMOVIC (chrome).

Canto shown on page 46



High quality Italian design & manufacture.
95mm sections Aluminium radiator
CE/UKCA approved & certified to BS EN442.

White RAL 9010 as standard, 23 RAL colours & 31 Special Finishes.

Please call **01342 302250** for a RAL or Special Finish chart.

6 NEW Feature Finishes, see page 7 or call **01342 302250** for samples.

Colour Coordination Service available see page 217 for full details.

Stock White RAL 9010: 48-72 Hours. All Colours & Finishes: Up to 2 weeks.

Ideal TRV & Pipe Covers



SAVE £45*
WHEN YOU BUY OUR IDEAL TRV & PIPE COVERS WITH ANY DESIGNER PURCHASE. QUOTE **PROMOVI** AT TIME OF ORDER.

Available in White or Chrome.

Pipe centres left to right	Pipe centres from wall	Depth from wall
width + valves	70mm	120mm

Stock options White RAL 9010 - Horizontal

Please add 10% to the RAL/Special Finish price to work out your Feature Finish price

Height (mm)	Width (mm)	Model	Watts Δt 50°C	Btu's Δt 50°C	White Ex VAT	White Inc VAT	RALs & Special Finishes	RALs & Special Finishes
							Ex VAT	Inc VAT
DELIVERY TIMES					48-72 HOURS		UP TO 2 WEEKS	
568	420	CANT564208H	488	1665	£263.00	£315.60	£328.75	£394.50
	620	CANT566212H	732	2498	£382.00	£458.40	£477.50	£573.00
	820	CANT568216H	976	3330	£506.00	£607.20	£632.50	£759.00
	1020	CANT561020H	1220	4163	£625.00	£750.00	£781.25	£937.50
668	420	CANT664208H	552	1883	£268.00	£321.60	£335.00	£402.00
	620	CANT666212H	828	2825	£392.00	£470.40	£490.00	£588.00
	820	CANT668216H	1104	3767	£517.00	£620.40	£646.25	£775.50
	1020	CANT661020H	1380	4709	£642.00	£770.40	£802.50	£963.00

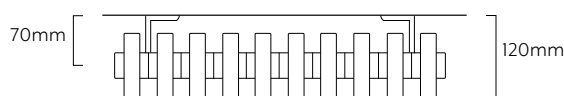

Please note widths include measurements for bushes

23 RAL colours are shown on page 216

Stock options White RAL 9010 - Vertical

Please add 10% to the RAL/Special Finish price to work out your Feature Finish price

Height (mm)	Width (mm)	Model	Watts Δt 50°C	Btu's Δt 50°C	White Ex VAT	White Inc VAT	RALs & Special Finishes	RALs & Special Finishes
							Ex VAT	Inc VAT
DELIVERY TIMES					48-72 HOURS		UP TO 2 WEEKS	
1470	270	CANT142705V	715	2440	£467.00	£560.40	£583.75	£700.50
	420	CANT144208V	1144	3903	£734.00	£880.80	£917.50	£1,101.00
	520	CANT145210V	1430	4879	£909.00	£1,090.80	£1,136.25	£1,363.50
1870	270	CANT182705V	890	3037	£551.00	£661.20	£688.75	£826.50
	420	CANT184208V	1424	4859	£868.00	£1,041.60	£1,085.00	£1,302.00
	520	CANT185210V	1780	6073	£1,079.00	£1,294.80	£1,348.75	£1,618.50

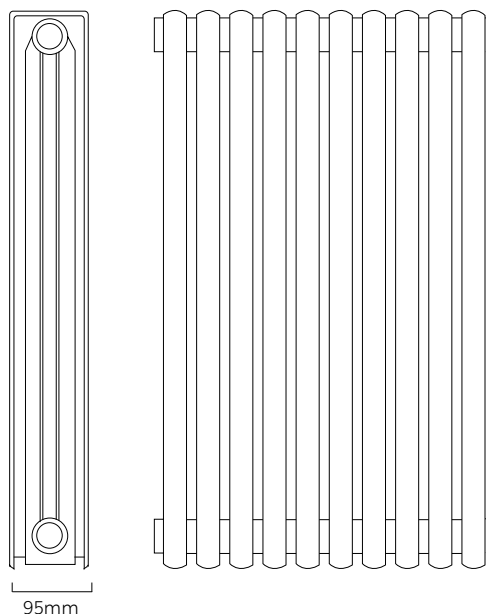

Please note widths include measurements for bushes

23 RAL colours are shown on page 216

Feature Finishes

See page 7 for more information or call customer services for sample swatches.

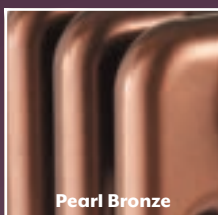
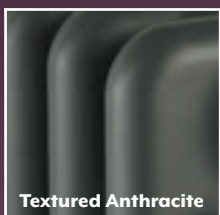
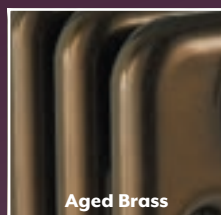

To work out your Feature Finish price please add 10% to the RAL/Special Finish colour price shown in the above tables.

*Saving based on the value of individual items when bought separately. Order any of our selected valves & matching pipe covers at the same time as your radiator; PROMOVIW (white), PROMOVI (chrome).

Water Lily shown on page 47

High quality Italian design & manufacture.

Steel; 70mm flat tubes with 30mm collectors. Underneath (B2) connections as standard CE/UKCA approved & certified to BS EN442.



White RAL 9016 as standard, 188 RAL colours & 31 Special Finishes.

Please call **01342 302250** for a RAL or Special Finish chart.

6 NEW Feature Finishes, see page 7 or call **01342 302250** for samples.

Colour Coordination Service available see page 217 for full details.

Stock White RAL 9016: 48-72 Hours. Feature Finishes: Up to 2 weeks.

Made to Order RALs & Special Finishes: Up to 5 weeks.

SAVE £45*
WHEN YOU BUY OUR IDEAL TRV & PIPE COVERS WITH ANY DESIGNER PURCHASE. QUOTE PROMOV1 AT TIME OF ORDER.



Available in White or Chrome.

Water Lily	Pipe centres left to right	Pipe centres from wall	Depth from wall
Water Lily Single	width - 84mm	55mm - 65mm	79mm - 89mm
Water Lily Double	width - 84mm	67mm - 77mm	91mm - 101mm

Please note: underneath connections only

Stock options White RAL 9016 - Single Vertical

Please add 10% to the RAL/Special Finish price to work out your Feature Finish price

Height (mm)	Width (mm)	Model	Watts Δt 50°C	Btu's Δt 50°C	White Ex VAT	White Inc VAT	RALs & Special Finishes	RALs & Special Finishes
							Ex VAT	Inc VAT
DELIVERY TIMES							48-72 HOURS	UP TO 5 WEEKS
1820	160	WATES181602	294	1003	£324.00	£388.80	£405.00	£486.00
	236	WATES182303	441	1505	£362.00	£434.40	£452.50	£543.00
	312	WATES183104	588	2006	£400.00	£480.00	£500.00	£600.00
	388	WATES183805	735	2508	£458.00	£549.60	£572.50	£687.00
	464	WATES184606	881	3006	£522.00	£626.40	£652.50	£783.00
2020	160	WATES201602	328	1119	£526.00	£631.20	£657.50	£789.00
	236	WATES202303	492	1679	£585.00	£702.00	£731.25	£877.50
	312	WATES203104	656	2238	£642.00	£770.40	£802.50	£963.00
	388	WATES203805	820	2798	£710.00	£852.00	£887.50	£1,065.00
	464	WATES204606	984	3357	£781.00	£937.20	£976.25	£1,171.50

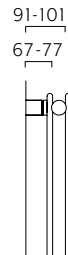
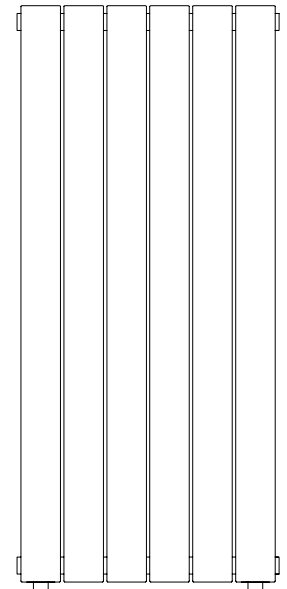
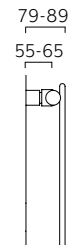

Stock options White RAL 9016 - Double Vertical

Please add 10% to the RAL/Special Finish price to work out your Feature Finish price

Height (mm)	Width (mm)	Model	Watts Δt 50°C	Btu's Δt 50°C	White Ex VAT	White Inc VAT	RALs & Special Finishes	RALs & Special Finishes
							Ex VAT	Inc VAT
DELIVERY TIMES							48-72 HOURS	UP TO 5 WEEKS
1820	160	WATED181602	420	1433	£531.00	£637.20	£663.75	£796.50
	236	WATED182303	630	2150	£630.00	£756.00	£787.50	£945.00
	312	WATED183104	840	2866	£707.00	£848.40	£883.75	£1,060.50
	388	WATED183805	1050	3583	£823.00	£987.60	£1,028.75	£1,234.50
	464	WATED184606	1259	4296	£936.00	£1,123.20	£1,170.00	£1,404.00
2020	160	WATED201602	466	1590	£766.00	£919.20	£957.50	£1,149.00
	236	WATED202303	699	2385	£856.00	£1,027.20	£1,070.00	£1,284.00
	312	WATED203104	932	3180	£953.00	£1,143.60	£1,191.25	£1,429.50
	388	WATED203805	1166	3978	£1,051.00	£1,261.20	£1,313.75	£1,576.50
	464	WATED204606	1399	4773	£1,186.00	£1,423.20	£1,482.50	£1,779.00

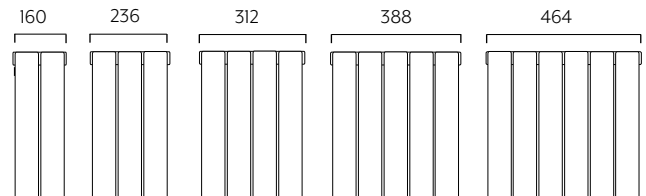

*Saving based on the value of individual items when bought separately. Order any of our selected valves & matching pipe covers at the same time as your radiator; PROMOV1W (white), PROMOV1C (chrome).

Piano Horizontal shown on pages 48-49

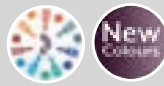

High quality Italian design & manufacture.
 Steel; 50mm flat tubes with 30mm collectors
 CE/UKCA approved & certified to BS EN442.



White RAL 9016 as standard, 188 RAL colours & 31 Special Finishes.
 Please call **01342 302250** for a RAL or Special Finish chart.

6 NEW Feature Finishes (stock sizes only), see page 7 or call **01342 302250** for samples.
 Colour Coordination Service available on stock sizes **see page 217** for full details.

Stock White RAL 9016: 48-72 Hours. Feature Finishes: Up to 2 weeks.
 Made to Order White, RALs & Special Finishes: Up to 5 weeks.

SAVE £45*
 WHEN YOU BUY OUR IDEAL TRV & PIPE COVERS WITH ANY DESIGNER PURCHASE. QUOTE PROMOMI AT TIME OF ORDER.

Available in White or Chrome.

New Electric sizes available see pages 34/150 for details

Pipe centres left to right	Pipe centres from wall	Depth from wall
width - 50mm	55mm	78mm

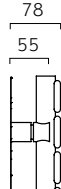

Pipe centres left to right	Pipe centres from wall	Depth from wall
width - 50mm	74mm to 84mm	97mm to 107mm

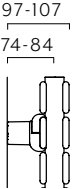

Stock options White RAL 9016 - Single Horizontal

Please add 10% to the RAL/Special Finish price to work out your Feature Finish price

Height (mm)	Width (mm)	Model	Watts Δt 50°C	Btu's Δt 50°C	White Ex VAT	White Inc VAT	RALs & Special Finishes	
							Ex VAT	Inc VAT
DELIVERY TIMES					48-72 HOURS		UP TO 5 WEEKS	
344	920	PIANSH349206	357	1218	£438.00	£525.60	£547.50	£657.00
400	520	PIANSH405207	234	798	£425.00	£510.00	£531.25	£637.50
	920	PIANSH409207	414	1413	£452.00	£542.40	£565.00	£678.00
	1220	PIANSH401207	549	1873	£508.00	£609.60	£635.00	£762.00
512	920	PIANSH519209	525	1791	£496.00	£595.20	£620.00	£744.00
	1220	PIANSH511209	696	2375	£562.00	£674.40	£702.50	£843.00
624	920	PIANSH629211	634	2163	£541.00	£649.20	£676.25	£811.50
	1220	PIANSH621211	841	2869	£614.00	£736.80	£767.50	£921.00
	1520	PIANSH621511	1048	3576	£689.00	£826.80	£861.25	£1,053.50

Stock options White RAL 9016 - Double Horizontal

Please add 10% to the RAL/Special Finish price to work out your Feature Finish price

Height (mm)	Width (mm)	Model	Watts Δt 50°C	Btu's Δt 50°C	White Ex VAT	White Inc VAT	RALs & Special Finishes	
							Ex VAT	Inc VAT
DELIVERY TIMES					48-72 HOURS		UP TO 5 WEEKS	
344	920	PIANDH349206	557	1900	£744.00	£892.80	£930.00	£1,116.00
400	520	PIANDH405207	357	1218	£721.00	£865.20	£901.25	£1,081.50
	920	PIANDH409207	632	2156	£781.00	£937.20	£976.25	£1,171.50
	1220	PIANDH401207	838	2859	£844.00	£1,012.80	£1,055.00	£1,266.00
512	920	PIANDH519209	777	2651	£844.00	£1,012.80	£1,055.00	£1,266.00
	1220	PIANDH511209	1031	3518	£928.00	£1,113.60	£1,160.00	£1,392.00
624	920	PIANDH629211	916	3125	£921.00	£1,105.20	£1,151.25	£1,381.50
	1220	PIANDH621211	1214	4142	£1,017.00	£1,220.40	£1,271.25	£1,525.50
	1520	PIANDH621511	1513	5162	£1,121.00	£1,345.20	£1,401.25	£1,681.50

Made to order options - Single Horizontal

Height (mm)	Width (mm)	Model	Watts Δt 50°C	Btu's Δt 50°C	White Ex VAT	White Inc VAT	RALs & Special Finishes	
							Ex VAT	Inc VAT
DELIVERY TIMES					UP TO 5 WEEKS		UP TO 5 WEEKS	
344	520	PIANSH345206	202	689	£416.00	£499.20	£520.00	£624.00
	700	PIANSH347006	272	928	£425.00	£510.00	£531.25	£637.50
	1220	PIANSH341206	474	1617	£487.00	£584.40	£608.75	£730.50
	1520	PIANSH341506	590	2013	£539.00	£646.80	£673.75	£808.50
	1820	PIANSH341806	707	2412	£554.00	£664.80	£692.50	£831.00
	2020	PIANSH342006	785	2678	£564.00	£676.80	£705.00	£846.00
400	700	PIANSH407007	315	1075	£438.00	£525.60	£547.50	£657.00
	1520	PIANSH401507	684	2334	£567.00	£680.40	£708.75	£850.50
	1820	PIANSH401807	819	2794	£589.00	£706.80	£736.25	£883.50
	2020	PIANSH402007	909	3102	£646.00	£775.20	£807.50	£969.00
456	1220	PIANSH451208	623	2126	£508.00	£609.60	£635.00	£762.00
512	700	PIANSH517009	399	1361	£479.00	£574.80	£598.75	£718.50
	1520	PIANSH511509	868	2962	£625.00	£750.00	£781.25	£937.50
	1820	PIANSH511809	1039	3545	£654.00	£784.80	£817.50	£981.00
	2020	PIANSH512009	1153	3934	£667.00	£800.40	£833.75	£1,000.50
624	700	PIANSH627011	482	1645	£521.00	£625.20	£651.25	£781.50
	1820	PIANSH621811	1254	4279	£718.00	£861.60	£897.50	£1,077.00
	2020	PIANSH622011	1392	4750	£740.00	£888.00	£925.00	£1,110.00
736	700	PIANSH737013	563	1921	£550.00	£660.00	£687.50	£825.00
	920	PIANSH739213	740	2525	£574.00	£688.80	£717.50	£861.00
	1220	PIANSH731213	982	3351	£655.00	£786.00	£818.75	£982.50
	1520	PIANSH731513	1223	4173	£737.00	£884.40	£921.25	£1,105.50
	1820	PIANSH731813	1465	4999	£768.00	£921.60	£960.00	£1,152.00
	2020	PIANSH732013	1626	5548	£796.00	£955.20	£995.00	£1,194.00

Made to order options - Double Horizontal

Height (mm)	Width (mm)	Model	Watts Δt 50°C	Btu's Δt 50°C	White Ex VAT	White Inc VAT	RALs & Special Finishes	
							Ex VAT	Inc VAT
DELIVERY TIMES					UP TO 5 WEEKS		UP TO 5 WEEKS	
344	520	PIANDH345206	315	1075	£710.00	£852.00	£887.50	£1,065.00
	700	PIANDH347006	424	1447	£721.00	£865.20	£901.25	£1,081.50
	1220	PIANDH341206	739	2521	£812.00	£974.40	£1,015.00	£1,218.00
	1520	PIANDH341506	921	3142	£884.00	£1,060.80	£1,105.00	£1,326.00
	1820	PIANDH341806	1103	3763	£917.00	£1,100.40	£1,146.25	£1,375.50
	2020	PIANDH342006	1224	4176	£943.00	£1,131.60	£1,178.75	£1,414.50
400	700	PIANDH407007	481	1641	£744.00	£892.80	£930.00	£1,116.00
	1520	PIANDH401507	1044	3562	£917.00	£1,100.40	£1,146.25	£1,375.50
	1820	PIANDH401807	1251	4268	£966.00	£1,159.20	£1,207.50	£1,449.00
	2020	PIANDH402007	1388	4736	£1,002.00	£1,202.40	£1,252.50	£1,503.00
456	1220	PIANDH451208	937	3197	£844.00	£1,012.80	£1,055.00	£1,266.00
512	700	PIANDH517009	591	2016	£810.00	£972.00	£1,012.50	£1,215.00
	1520	PIANDH511509	1285	4384	£1,012.00	£1,214.40	£1,265.00	£1,518.00
	1820	PIANDH511809	1538	5248	£1,066.00	£1,279.20	£1,332.50	£1,599.00
	2020	PIANDH512009	1707	5824	£1,111.00	£1,333.20	£1,388.75	£1,666.50
624	700	PIANDH627011	697	2378	£884.00	£1,060.80	£1,105.00	£1,326.00
	1820	PIANDH621811	1812	6183	£1,172.00	£1,406.40	£1,465.00	£1,758.00
	2020	PIANDH622011	2011	6862	£1,222.00	£1,466.40	£1,527.50	£1,833.00
736	700	PIANDH737013	797	2719	£932.00	£1,118.40	£1,165.00	£1,398.00
	920	PIANDH739213	1048	3576	£975.00	£1,170.00	£1,218.75	£1,462.50
	1220	PIANDH731213	1390	4743	£1,081.00	£1,297.20	£1,351.25	£1,621.50
	1520	PIANDH731513	1732	5910	£1,188.00	£1,425.60	£1,485.00	£1,782.00
	1820	PIANDH731813	2074	7076	£1,250.00	£1,500.00	£1,562.50	£1,875.00
	2020	PIANDH732013	2302	7854	£1,310.00	£1,572.00	£1,637.50	£1,965.00

*Saving based on the value of individual items when bought separately. Order any of our selected valves & matching pipe covers at the same time as your radiator; PROMOVIV (white), PROMOVIC (chrome).

Piano Vertical shown on pages 48-49

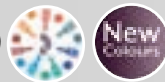

High quality Italian design & manufacture.
Steel; 50mm flat tubes with 30mm collectors
CE/UKCA approved & certified to BS EN442.



White RAL 9016 as standard, 188 RAL colours & 31 Special Finishes.

Please call **01342 302250** for a RAL or Special Finish chart.

6 NEW Feature Finishes (stock sizes only), see page 7 or call **01342 302250** for samples.

Colour Coordination Service available on stock sizes **see page 217** for full details.

Stock White RAL 9016: 48-72 Hours. Feature Finishes: Up to 2 weeks.

Made to Order White, RALs & Special Finishes: Up to 5 weeks.



Electric sizes available see pages 34/150 for details

Pipe centres left to right	Pipe centres from wall	Depth from wall
width + valves	55mm	78mm

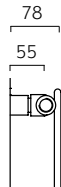

Pipe centres left to right	Pipe centres from wall	Depth from wall
width + valves	78mm - 84mm	97mm - 107mm

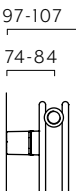

Available in White or Chrome.

Ideal TRV & Pipe Covers



SAVE £45*

WHEN YOU BUY OUR IDEAL TRV & PIPE COVERS WITH ANY DESIGNER PURCHASE. QUOTE PROMOV1 AT TIME OF ORDER.

Stock options White RAL 9016 - Single Vertical

Please add 10% to the RAL/Special Finish price to work out your Feature Finish price

Height (mm)	Width (mm)	Model	Watts Δt 50°C	Btu's Δt 50°C	White Ex VAT	White Inc VAT	RALs & Special Finishes	
							Ex VAT	Inc VAT
DELIVERY TIMES					48-72 HOURS		UP TO 5 WEEKS	
1220	512	PIANSV125I09	675	2303	£562.00	£674.40	£702.50	£843.00
1520	288	PIANSV152805	462	1576	£539.00	£646.80	£673.75	£808.50
	400	PIANSV154007	647	2208	£567.00	£680.40	£708.75	£850.50
	512	PIANSV155I09	832	2839	£625.00	£750.00	£781.25	£937.50
	624	PIANSV156211	1017	3470	£689.00	£826.80	£861.25	£1,033.50
1820	288	PIANSV182805	550	1877	£554.00	£664.80	£692.50	£831.00
	400	PIANSV184007	769	2624	£589.00	£706.80	£736.25	£883.50
	512	PIANSV185I09	989	3374	£654.00	£784.80	£817.50	£981.00
	624	PIANSV186211	1209	4125	£718.00	£861.60	£897.50	£1,077.00

Stock options White RAL 9016 - Double Vertical

Please add 10% to the RAL/Special Finish price to work out your Feature Finish price

Height (mm)	Width (mm)	Model	Watts Δt 50°C	Btu's Δt 50°C	White Ex VAT	White Inc VAT	RALs & Special Finishes	
							Ex VAT	Inc VAT
DELIVERY TIMES					48-72 HOURS		UP TO 5 WEEKS	
1220	512	PIANDV125I09	973	3320	£928.00	£1,113.60	£1,160.00	£1,392.00
1520	288	PIANDV152805	660	2252	£884.00	£1,060.80	£1,105.00	£1,326.00
	400	PIANDV154007	924	3153	£917.00	£1,100.40	£1,146.25	£1,375.50
	512	PIANDV155I09	1189	4057	£1,012.00	£1,214.40	£1,265.00	£1,518.00
	624	PIANDV156211	1453	4958	£1,121.00	£1,345.20	£1,401.25	£1,681.50
1820	288	PIANDV182805	778	2655	£917.00	£1,100.40	£1,146.25	£1,375.50
	400	PIANDV184007	1090	3719	£966.00	£1,159.20	£1,207.50	£1,449.00
	512	PIANDV185I09	1401	4780	£1,066.00	£1,279.20	£1,332.50	£1,599.00
	624	PIANDV186211	1712	5841	£1,172.00	£1,406.40	£1,465.00	£1,758.00

Made to order options - Single Vertical

Height (mm)	Width (mm)	Model	Watts Δt 50°C	Btu's Δt 50°C	White Ex VAT	White Inc VAT	RALs & Special Finishes	
							Ex VAT	Inc VAT
DELIVERY TIMES					UP TO 5 WEEKS		UP TO 5 WEEKS	
520	400	PIANSV524007	239	815	£425.00	£510.00	£531.25	£637.50
	512	PIANSV525I09	307	1047	£462.00	£554.40	£577.50	£693.00
	624	PIANSV526211	375	1280	£501.00	£601.20	£626.25	£751.50
	736	PIANSV527313	443	1512	£529.00	£634.80	£661.25	£793.50
	848	PIANSV528415	511	1744	£567.00	£680.40	£708.75	£850.50
920	288	PIANSV922805	286	976	£438.00	£525.60	£547.50	£657.00
	400	PIANSV924007	401	1368	£452.00	£542.40	£565.00	£678.00
	512	PIANSV925I09	515	1757	£496.00	£595.20	£620.00	£744.00
	624	PIANSV926211	630	2150	£541.00	£649.20	£676.25	£811.50
1220	288	PIANSV122805	375	1280	£487.00	£584.40	£608.75	£730.50
	400	PIANSV124007	525	1791	£508.00	£609.60	£635.00	£762.00
	624	PIANSV126211	825	2815	£614.00	£736.80	£767.50	£921.00
1820	456	PIANSV184508	879	2999	£589.00	£706.80	£736.25	£883.50
2020	288	PIANSV202805	608	2074	£564.00	£676.80	£705.00	£846.00
	400	PIANSV204007	851	2904	£646.00	£775.20	£807.50	£969.00
	456	PIANSV204508	973	3320	£646.00	£775.20	£807.50	£969.00
	512	PIANSV205I09	1095	3736	£667.00	£800.40	£833.75	£1,000.50
	624	PIANSV206211	1338	4565	£740.00	£888.00	£925.00	£1,110.00

Made to order options - Double Vertical

Height (mm)	Width (mm)	Model	Watts Δt 50°C	Btu's Δt 50°C	White Ex VAT	White Inc VAT	RALs & Special Finishes	
							Ex VAT	Inc VAT
DELIVERY TIMES					UP TO 5 WEEKS		UP TO 5 WEEKS	
520	400	PIANDV524007	351	1198	£721.00	£865.20	£901.25	£1,081.50
	512	PIANDV525I09	452	1542	£788.00	£945.60	£985.00	£1,182.00
	624	PIANDV526211	552	1883	£851.00	£1,021.20	£1,063.75	£1,276.50
	736	PIANDV527313	652	2225	£897.00	£1,076.40	£1,121.25	£1,345.50
	848	PIANDV528415	753	2569	£966.00	£1,159.20	£1,207.50	£1,449.00
	920	288	PIANDV922805	419	1430	£744.00	£892.80	£930.00
400		PIANDV924007	587	2003	£781.00	£937.20	£976.25	£1,171.50
512		PIANDV925I09	754	2573	£844.00	£1,012.80	£1,055.00	£1,266.00
624		PIANDV926211	922	3146	£921.00	£1,105.20	£1,151.25	£1,381.50
1220	288	PIANDV122805	541	1846	£812.00	£974.40	£1,015.00	£1,218.00
	400	PIANDV124007	757	2583	£844.00	£1,012.80	£1,055.00	£1,266.00
	624	PIANDV126211	1190	4060	£1,017.00	£1,220.40	£1,271.25	£1,525.50
1820	456	PIANDV184508	1245	4248	£966.00	£1,159.20	£1,207.50	£1,449.00
2020	288	PIANDV202805	857	2924	£943.00	£1,131.60	£1,178.75	£1,414.50
	400	PIANDV204007	1199	4091	£1,002.00	£1,202.40	£1,252.50	£1,503.00
	456	PIANDV204508	1370	4674	£1,002.00	£1,202.40	£1,252.50	£1,503.00
	512	PIANDV205I09	1542	5261	£1,111.00	£1,333.20	£1,388.75	£1,666.50
	624	PIANDV206211	1884	6428	£1,222.00	£1,466.40	£1,527.50	£1,833.00

*Saving based on the value of individual items when bought separately. Order any of our selected valves & matching pipe covers at the same time as your radiator; PROMOV1W (white), PROMOV1C (chrome).

Relax Horizontal shown on page 52



High quality Italian design & manufacture.

Steel; Slimline round tube on tube radiator cloaked in a steel cover
CE/UKCA approved & certified to BS EN442.

White RAL 9016 as standard, 188 RAL colours & 31 Special Finishes.
Please call **01342 302250** for a RAL or Special Finish chart.

6 NEW Feature Finishes (stock sizes only), see page 7 or call **01342 302250** for samples.

Stock White RAL 9016: 48-72 Hours. Feature Finishes: Up to 2 weeks.
Made to Order White, RALs & Special Finishes: Up to 5 weeks.

Relax horizontal	Pipe centres left to right	Pipe centres from wall	Depth from wall
Single horizontal	width - 109mm	55mm	88mm

Stock options White RAL 9016 - Single Horizontal

Please add 10% to the RAL/Special Finish price to work out your Feature Finish price

Height (mm)	Width (mm)	Model	Watts Δt 50°C	Btu's Δt 50°C	White Ex VAT	White Inc VAT	RALs & Special Finishes Ex VAT	RALs & Special Finishes Inc VAT
DELIVERY TIMES					48-72 HOURS		UP TO 5 WEEKS	
478	1197	RELASH4711	665	2269	£949.00	£1,138.80	£1,186.25	£1,423.50
578	1197	RELASH5711	824	2811	£978.00	£1,173.60	£1,222.50	£1,467.00

Made to order options - Single Horizontal

Height (mm)	Width (mm)	Model	Watts Δt 50°C	Btu's Δt 50°C	White Ex VAT	White Inc VAT	RALs & Special Finishes Ex VAT	RALs & Special Finishes Inc VAT
DELIVERY TIMES					UP TO 5 WEEKS		UP TO 5 WEEKS	
478	1401	RELASH4714	783	2672	£1,050.00	£1,260.00	£1,312.50	£1,575.00
	1809	RELASH4718	1019	3477	£1,361.00	£1,633.20	£1,701.25	£2,041.50
	2013	RELASH4720	1137	3879	£1,499.00	£1,798.80	£1,873.75	£2,248.50
578	1401	RELASH5714	970	3310	£1,079.00	£1,294.80	£1,348.75	£1,618.50
	1809	RELASH5718	1262	4306	£1,402.00	£1,682.40	£1,752.50	£2,103.00
	2013	RELASH5720	1408	4804	£1,543.00	£1,851.60	£1,928.75	£2,314.50

Relax horizontal	Pipe centres left to right	Pipe centres from wall	Depth from wall
Double horizontal	width - 109mm	79mm to 89mm	112mm to 122mm

Stock options White RAL 9016 - Double Horizontal

Please add 10% to the RAL/Special Finish price to work out your Feature Finish price

Height (mm)	Width (mm)	Model	Watts Δt 50°C	Btu's Δt 50°C	White Ex VAT	White Inc VAT	RALs & Special Finishes Ex VAT	RALs & Special Finishes Inc VAT
DELIVERY TIMES					48-72 HOURS		UP TO 5 WEEKS	
478	1197	RELADH4711	1045	3566	£1,155.00	£1,386.00	£1,443.75	£1,732.50
578	1197	RELADH5711	1294	4415	£1,256.00	£1,507.20	£1,570.00	£1,884.00

Made to order options - Double Horizontal

Height (mm)	Width (mm)	Model	Watts Δt 50°C	Btu's Δt 50°C	White Ex VAT	White Inc VAT	RALs & Special Finishes Ex VAT	RALs & Special Finishes Inc VAT
DELIVERY TIMES					UP TO 5 WEEKS		UP TO 5 WEEKS	
478	1401	RELADH4714	1231	4200	£1,249.00	£1,498.80	£1,561.25	£1,873.50
	1809	RELADH4718	1602	5466	£1,623.00	£1,947.60	£2,028.75	£2,434.50
	2013	RELADH4720	1787	6097	£1,786.00	£2,143.20	£2,232.50	£2,679.00
578	1401	RELADH5714	1524	5200	£1,372.00	£1,646.40	£1,715.00	£2,058.00
	1809	RELADH5718	1983	6766	£1,782.00	£2,138.40	£2,227.50	£2,673.00
	2013	RELADH5720	2213	7551	£1,962.00	£2,354.40	£2,452.50	£2,943.00



Ideal TRV & Pipe Covers



SAVE £45*

WHEN YOU BUY OUR IDEAL TRV & PIPE COVERS WITH ANY DESIGNER PURCHASE. QUOTE PROMOV1 AT TIME OF ORDER.

Available in White or Chrome.

Feature Finishes (for stock sizes)

See page 7 for more details or call customer services for sample swatches.

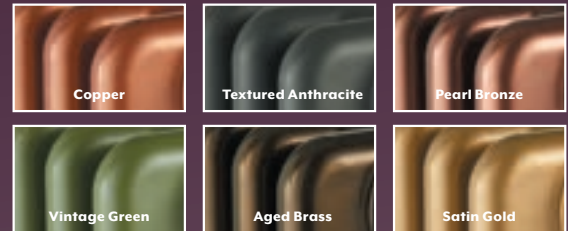

To work out your Feature Finish price please add 10% to the RAL/Special Finish colour price shown in the pricing tables.

Single

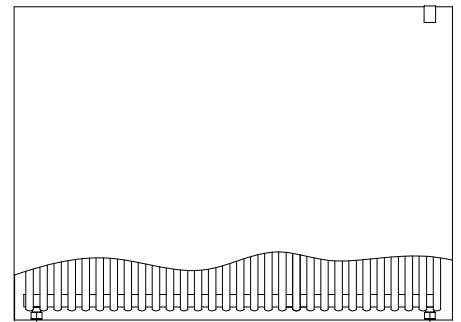
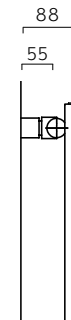

Double

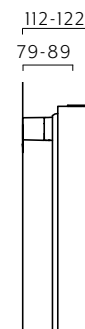

*Saving based on the value of individual items when bought separately. Order any of our selected valves & matching pipe covers at the same time as your radiator, PROMOV1W (white), PROMOV1C (chrome).

Relax Vertical shown on page 53



High quality Italian design & manufacture.

Steel; Slimline round tube on tube radiator cloaked in a steel cover
CE/UKCA approved & certified to BS EN442.



White RAL 9016 as standard, 188 RAL colours & 31 Special Finishes.

Please call **01342 302250** for a RAL or Special Finish chart.

6 NEW Feature Finishes (stock sizes only), see page 7 or call **01342 302250** for samples.

Stock White RAL 9016: 48-72 Hours. Feature Finishes: Up to 2 weeks.

Made to Order White, RALs & Special Finishes: Up to 5 weeks.

Polished Stainless Steel: Up to 8 weeks.



Ideal TRV & Pipe Covers

SAVE £45*
WHEN YOU BUY OUR IDEAL TRV & PIPE COVERS WITH ANY DESIGNER PURCHASE. QUOTE PROMOV1 AT TIME OF ORDER.

Available in White or Chrome.

Relax vertical	Pipe centres left to right	Pipe centres from wall	Depth from wall
Single vertical	width - 109mm	55mm	88mm

Stock options White RAL 9016 - Single Vertical

Please add 10% to the RAL/Special Finish price to work out your Feature Finish price

Height (mm)	Width (mm)	Model	Watts Δt 50°C	Btu's Δt 50°C	White Ex VAT	White Inc VAT	RALs & Special Finishes Ex VAT	RALs & Special Finishes Inc VAT
DELIVERY TIMES			48-72 HOURS		UP TO 5 WEEKS			
1853	517	RELASV1851	1178	4019	£1,187.00	£1,424.40	£1,483.75	£1,780.50
	653	RELASV1865	1519	5183	£1,294.00	£1,552.80	£1,617.50	£1,941.00

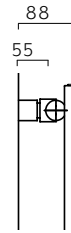

Made to order options - Inox Single Vertical

Height (mm)	Width (mm)	Model	Watts Δt 50°C	Btu's Δt 50°C	Polished Stainless Steel Ex VAT	Polished Stainless Steel Inc VAT
DELIVERY TIMES			UP TO 8 WEEKS			
1553	381	REINSV1538	489	1668	£2,411.00	£2,893.20
	517	REINSV1551	689	2351	£2,569.00	£3,082.80
	653	REINSV1565	888	3030	£2,680.00	£3,216.00
1853	381	REINSV1838	586	1999	£2,852.00	£3,422.40
	517	REINSV1851	825	2815	£3,127.00	£3,752.40
	653	REINSV1865	1063	3627	£3,345.00	£4,014.00
2053	381	REINSV2038	650	2218	£3,011.00	£3,613.20
	517	REINSV2051	915	3122	£3,345.00	£4,014.00
	653	REINSV2065	1180	4026	£3,567.00	£4,280.40

Made to order options - Single Vertical

Height (mm)	Width (mm)	Model	Watts Δt 50°C	Btu's Δt 50°C	White Ex VAT	White Inc VAT	RALs & Special Finishes Ex VAT	RALs & Special Finishes Inc VAT
DELIVERY TIMES			UP TO 5 WEEKS		UP TO 5 WEEKS			
1553	381	RELASV1538	699	2385	£868.00	£1,041.60	£1,085.00	£1,302.00
	517	RELASV1551	984	3357	£988.00	£1,185.60	£1,235.00	£1,482.00
	653	RELASV1565	1269	4330	£1,085.00	£1,302.00	£1,356.25	£1,627.50
1853	381	RELASV1838	837	2856	£944.00	£1,132.80	£1,180.00	£1,416.00

Relax vertical	Pipe centres left to right	Pipe centres from wall	Depth from wall
Double vertical	width - 109mm	79mm - 89mm	112mm - 122mm

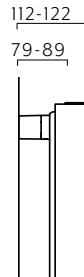

Stock options White RAL 9016 - Double Vertical

Please add 10% to the RAL/Special Finish price to work out your Feature Finish price

Height (mm)	Width (mm)	Model	Watts Δt 50°C	Btu's Δt 50°C	White Ex VAT	White Inc VAT	RALs & Special Finishes Ex VAT	RALs & Special Finishes Inc VAT
DELIVERY TIMES			48-72 HOURS		UP TO 5 WEEKS			
1853	517	RELADV1851	1477	5040	£1,493.00	£1,791.60	£1,866.25	£2,239.50
	653	RELADV1865	1817	6200	£1,831.00	£2,197.20	£2,288.75	£2,746.50

Made to order options - Double Vertical

Height (mm)	Width (mm)	Model	Watts Δt 50°C	Btu's Δt 50°C	White Ex VAT	White Inc VAT	RALs & Special Finishes Ex VAT	RALs & Special Finishes Inc VAT
DELIVERY TIMES			UP TO 5 WEEKS		UP TO 5 WEEKS			
1553	381	RELADV1538	1017	3470	£1,165.00	£1,398.00	£1,456.25	£1,747.50
	517	RELADV1551	1431	4883	£1,279.00	£1,534.80	£1,598.75	£1,918.50
	653	RELADV1565	1591	5428	£1,386.00	£1,663.20	£1,732.50	£2,079.00
1853	381	RELADV1838	1050	3583	£1,249.00	£1,498.80	£1,561.25	£1,873.50

Made to order options - Inox Double Vertical

Height (mm)	Width (mm)	Model	Watts Δt 50°C	Btu's Δt 50°C	Polished Stainless Steel Ex VAT	Polished Stainless Steel Inc VAT
DELIVERY TIMES			UP TO 8 WEEKS			
1553	381	REINDV1538	712	2429	£3,331.00	£3,997.20
	517	REINDV1551	1002	3419	£3,446.00	£4,135.20
	653	REINDV1565	1114	3801	£3,675.00	£4,410.00
1853	381	REINDV1838	735	2508	£3,910.00	£4,692.00
	517	REINDV1851	1034	3528	£4,256.00	£5,107.20
	653	REINDV1865	1272	4340	£4,481.00	£5,377.20
2053	381	REINDV2038	778	2655	£4,140.00	£4,968.00
	517	REINDV2051	1095	3736	£4,552.00	£5,462.40
	653	REINDV2065	1397	4767	£4,830.00	£5,796.00

*Saving based on the value of individual items when bought separately. Order any of our selected valves & matching pipe covers at the same time as your radiator; PROMOV1 (white), PROMOV1C (chrome).

Ellipsis Single Horizontal shown on pages 54-55



High quality Italian design & manufacture.

Steel; 25mm x 50mm oval tubes. CE/UKCA approved & certified to BS EN442.

White RAL 9016 as standard, 188 RAL colours & 31 Special Finishes.

Please call **01342 302250** for a RAL or Special Finish chart.

6 NEW Feature Finishes (stock sizes only), see page 7 or call **01342 302250** for samples.

Colour Coordination Service available on stock sizes **see page 217** for full details.



Stock White RAL 9016 & Textured Anthracite: 48-72 Hours

Feature Finishes: Up to 2 weeks

Made to Order White, RALs & Special Finishes: Up to 5 weeks.

Pipe centres left to right	Pipe centres from wall	Depth from wall
width - 50mm	55mm	95mm

Ideal TRV & Pipe Covers



SAVE £45*

WHEN YOU BUY OUR IDEAL TRV & PIPE COVERS WITH ANY DESIGNER PURCHASE. QUOTE PROMOVIC AT TIME OF ORDER.

Available in White or Chrome.

Stock options White RAL 9016 - Single Horizontal

Please add 10% to the RAL/Special Finish price to work out your Feature Finish price

Height (mm)	Width (mm)	Model	Watts Δt 50°C	Btu's Δt 50°C	White Ex VAT	White Inc VAT	RALs & Special Finishes Ex VAT	RALs & Special Finishes Inc VAT
							48-72 HOURS	UP TO 5 WEEKS
DELIVERY TIMES								
48-72 HOURS								
UP TO 5 WEEKS								
420	1020	ELLISH421007	481	1641	£447.00	£536.40	£558.75	£670.50
	1220	ELLISH421207	575	1962	£456.00	£547.20	£570.00	£684.00
	1520	ELLISH421507	717	2446	£485.00	£582.00	£606.25	£727.50
480	1020	ELLISH481008	549	1873	£515.00	£618.00	£643.75	£772.50
	1220	ELLISH481208	657	2242	£529.00	£634.80	£661.25	£793.50
	1520	ELLISH481508	818	2791	£551.00	£637.20	£663.75	£796.50
600	650	ELLISH606510	437	1491	£568.00	£681.60	£710.00	£852.00
	1020	ELLISH601010	686	2341	£598.00	£717.60	£747.50	£897.00
	1220	ELLISH601210	821	2801	£616.00	£739.20	£770.00	£924.00
	1520	ELLISH601510	1022	3487	£633.00	£759.60	£791.25	£949.50

Stock options Textured Anthracite - Single Horizontal

Height (mm)	Width (mm)	Model	Watts Δt 50°C	Btu's Δt 50°C	Textured Anthracite Ex VAT	Textured Anthracite Inc VAT
					48-72 HOURS	UP TO 5 WEEKS
DELIVERY TIMES						
48-72 HOURS						
UP TO 5 WEEKS						
600	1020	ELLISH601010TA	686	2341	£747.50	£897.00
	1220	ELLISH601210TA	821	2801	£770.00	£924.00

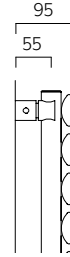

Made to order options - Single Horizontal

Height (mm)	Width (mm)	Model	Watts Δt 50°C	Btu's Δt 50°C	White Ex VAT	White Inc VAT	RALs & Special Finishes Ex VAT	RALs & Special Finishes Inc VAT
							UP TO 5 WEEKS	UP TO 5 WEEKS
DELIVERY TIMES								
UP TO 5 WEEKS								
300	520	ELLISH305205	175	597	£340.00	£408.00	£425.00	£510.00
	650	ELLISH306505	219	747	£360.00	£432.00	£450.00	£540.00
	700	ELLISH307005	236	805	£361.00	£433.20	£451.25	£541.50
	920	ELLISH309205	310	1058	£362.00	£434.40	£452.50	£543.00
	1020	ELLISH301005	344	1174	£366.00	£439.20	£457.50	£549.00
	1220	ELLISH301205	411	1402	£377.00	£452.40	£471.25	£565.50
	1520	ELLISH301505	512	1747	£381.00	£457.20	£476.25	£571.50
	1820	ELLISH301805	613	2092	£401.00	£481.20	£501.25	£601.50
	2020	ELLISH302005	681	2324	£411.00	£493.20	£513.75	£616.50
480	520	ELLISH485208	280	955	£479.00	£574.80	£598.75	£718.50
	650	ELLISH486508	350	1194	£502.00	£602.40	£627.50	£753.00
	700	ELLISH487008	377	1286	£503.00	£603.60	£628.75	£754.50
	920	ELLISH489208	495	1689	£505.00	£606.00	£631.25	£757.50
	1820	ELLISH481808	980	3344	£560.00	£672.00	£700.00	£840.00
	2020	ELLISH482008	1087	3709	£571.00	£685.20	£713.75	£856.50
540	520	ELLISH545209	315	1075	£509.00	£610.80	£636.25	£763.50
	650	ELLISH546509	394	1344	£531.00	£637.20	£663.75	£796.50
	700	ELLISH547009	425	1450	£540.00	£648.00	£675.00	£810.00
	920	ELLISH549209	558	1904	£545.00	£654.00	£681.25	£817.50
	1020	ELLISH541009	619	2112	£553.00	£663.60	£691.25	£829.50
	1220	ELLISH541209	740	2525	£566.00	£679.20	£707.50	£849.00
	1520	ELLISH541509	922	3146	£586.00	£703.20	£732.50	£879.00
	1820	ELLISH541809	1104	3767	£608.00	£729.60	£760.00	£912.00
	2020	ELLISH542009	1225	4180	£673.00	£807.60	£841.25	£1,009.50

Height (mm)	Width (mm)	Model	Watts Δt 50°C	Btu's Δt 50°C	White Ex VAT	White Inc VAT	RALs & Special Finishes Ex VAT	RALs & Special Finishes Inc VAT
							UP TO 5 WEEKS	UP TO 5 WEEKS
DELIVERY TIMES								
UP TO 5 WEEKS								
600	700	ELLISH607010	471	1607	£578.00	£693.60	£722.50	£867.00
	920	ELLISH609210	619	2112	£586.00	£703.20	£732.50	£879.00
	1820	ELLISH601810	1224	4176	£663.00	£795.60	£828.75	£994.50
	2020	ELLISH602010	1359	4637	£686.00	£823.20	£857.50	£1,029.00
	720	650	ELLISH726512	526	1795	£671.00	£805.20	£838.75
700		ELLISH727012	566	1931	£690.00	£828.00	£862.50	£1,035.00
920		ELLISH729212	744	2539	£708.00	£849.60	£885.00	£1,062.00
1020		ELLISH721012	825	2815	£729.00	£874.80	£911.25	£1,093.50
1220		ELLISH721212	987	3368	£746.00	£895.20	£932.50	£1,119.00
1520		ELLISH721512	1229	4193	£776.00	£931.20	£970.00	£1,164.00
900	1820	ELLISH721812	1472	5022	£804.00	£964.80	£1,005.00	£1,206.00
	2020	ELLISH722012	1634	5575	£893.00	£1,071.60	£1,116.25	£1,339.50
	650	ELLISH906515	657	2242	£856.00	£1,027.20	£1,070.00	£1,284.00
	700	ELLISH907015	708	2416	£884.00	£1,060.80	£1,105.00	£1,326.00
	920	ELLISH909215	930	3173	£908.00	£1,089.60	£1,135.00	£1,362.00
	1020	ELLISH901015	1031	3518	£930.00	£1,116.00	£1,162.50	£1,395.00
	1220	ELLISH901215	1233	4207	£957.00	£1,148.40	£1,196.25	£1,435.50
	1520	ELLISH901515	1537	5244	£992.00	£1,190.40	£1,240.00	£1,488.00
	1820	ELLISH901815	1840	6278	£1,026.00	£1,231.20	£1,282.50	£1,539.00
	2020	ELLISH902015	2042	6967	£1,138.00	£1,365.60	£1,422.50	£1,707.00

*Saving based on the value of individual items when bought separately.

Order any of our selected valves & matching pipe covers at the same time as your radiator; PROMOVIV (white), PROMOVIC (chrome).

Ellipsis Double Horizontal shown on pages 54-55

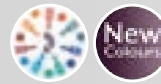

High quality Italian design & manufacture.
Steel; 25mm x 50mm oval tubes. CE/UKCA approved & certified to BS EN442.



White RAL 9016 as standard, 188 RAL colours & 31 Special Finishes.
Please call **01342 302250** for a RAL or Special Finish chart.
6 NEW Feature Finishes (stock sizes only), see page 7 or call **01342 302250** for samples.
Colour Coordination Service available on stock sizes **see page 217** for full details.

Stock White RAL 9016 & Textured Anthracite: 48-72 Hours
Feature Finishes: Up to 2 weeks
Made to Order White, RALs & Special Finishes: Up to 5 weeks.

Pipe centres left to right	Pipe centres from wall	Depth from wall
width - 50mm	80mm-90mm	120mm-130mm

SAVE £45*
WHEN YOU BUY OUR IDEAL TRV & PIPE COVERS WITH ANY DESIGNER PURCHASE. QUOTE PROMOV1 AT TIME OF ORDER.

Available in White or Chrome.

Stock options White RAL 9016 - Double Horizontal

Please add 10% to the RAL/Special Finish price to work out your Feature Finish price

Height (mm)	Width (mm)	Model	Watts Δt 50°C	Btu's Δt 50°C	White Ex VAT	White Inc VAT	RALs & Special Finishes	
							Ex VAT	Inc VAT
DELIVERY TIMES			48-72 HOURS		UP TO 5 WEEKS			
420	1020	ELLIDH421007	748	2552	£661.00	£793.20	£826.25	£991.50
	1220	ELLIDH421207	895	3054	£681.00	£817.20	£851.25	£1,021.50
	1520	ELLIDH421507	1115	3804	£750.00	£900.00	£937.50	£1,125.00
480	1020	ELLIDH481008	855	2917	£764.00	£916.80	£955.00	£1,146.00
	1220	ELLIDH481208	1023	3490	£784.00	£940.80	£980.00	£1,176.00
	1520	ELLIDH481508	1274	4347	£809.00	£970.80	£1,011.25	£1,213.50
600	650	ELLIDH606510	681	2324	£852.00	£1,022.40	£1,065.00	£1,278.00
	1020	ELLIDH601010	1069	3647	£914.00	£1,096.80	£1,142.50	£1,371.00
	1220	ELLIDH601210	1279	4364	£949.00	£1,138.80	£1,186.25	£1,423.50
	1520	ELLIDH601510	1593	5435	£969.00	£1,162.80	£1,211.25	£1,453.50

Stock options Textured Anthracite - Double Horizontal

Height (mm)	Width (mm)	Model	Watts Δt 50°C	Btu's Δt 50°C	Textured Anthracite	
					Ex VAT	Inc VAT
DELIVERY TIMES			48-72 HOURS		UP TO 5 WEEKS	
600	1020	ELLIDH601010TA	1069	3647	£1,142.50	£1,371.00
	1220	ELLIDH601210TA	1279	4364	£1,186.25	£1,423.50

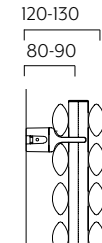

Made to order options - Double Horizontal

Height (mm)	Width (mm)	Model	Watts Δt 50°C	Btu's Δt 50°C	White Ex VAT	White Inc VAT	RALs & Special Finishes	
							Ex VAT	Inc VAT
DELIVERY TIMES			UP TO 5 WEEKS		UP TO 5 WEEKS			
300	520	ELLIDH305205	273	931	£437.00	£524.40	£546.25	£655.50
	650	ELLIDH306505	341	1163	£554.00	£664.80	£692.50	£831.00
	700	ELLIDH307005	367	1252	£564.00	£676.80	£705.00	£846.00
	920	ELLIDH309205	483	1648	£568.00	£681.60	£710.00	£852.00
	1020	ELLIDH301005	535	1825	£574.00	£688.80	£717.50	£861.00
	1220	ELLIDH301205	640	2184	£591.00	£709.20	£738.75	£886.50
	1520	ELLIDH301505	797	2719	£602.00	£722.40	£752.50	£903.00
	1820	ELLIDH301805	955	3258	£644.00	£772.80	£805.00	£966.00
	2020	ELLIDH302005	1060	3617	£661.00	£793.20	£826.25	£991.50
480	520	ELLIDH485208	436	1488	£631.00	£757.20	£788.75	£946.50
	650	ELLIDH486508	545	1860	£737.00	£884.40	£921.25	£1,105.50
	700	ELLIDH487008	587	2003	£745.00	£894.00	£931.25	£1,117.50
	920	ELLIDH489208	771	2631	£754.00	£904.80	£942.50	£1,131.00
	1820	ELLIDH481808	1526	5207	£847.00	£1,016.40	£1,058.75	£1,270.50
2020	ELLIDH482008	1693	5777	£872.00	£1,046.40	£1,090.00	£1,308.00	
540	520	ELLIDH545209	491	1675	£750.00	£900.00	£937.50	£1,125.00
	650	ELLIDH546509	614	2095	£800.00	£960.00	£1,000.00	£1,200.00
	700	ELLIDH547009	661	2255	£810.00	£972.00	£1,012.50	£1,215.00
	920	ELLIDH549209	869	2965	£823.00	£987.60	£1,028.75	£1,234.50
	1020	ELLIDH541009	963	3286	£831.00	£997.20	£1,038.75	£1,246.50
	1220	ELLIDH541209	1152	3931	£857.00	£1,028.40	£1,071.25	£1,285.50
	1520	ELLIDH541509	1435	4896	£872.00	£1,046.40	£1,090.00	£1,308.00
	1820	ELLIDH541809	1718	5862	£941.00	£1,129.20	£1,176.25	£1,411.50
	2020	ELLIDH542009	1907	6507	£998.00	£1,197.60	£1,247.50	£1,497.00

Height (mm)	Width (mm)	Model	Watts Δt 50°C	Btu's Δt 50°C	White Ex VAT	White Inc VAT	RALs & Special Finishes	
							Ex VAT	Inc VAT
DELIVERY TIMES			UP TO 5 WEEKS		UP TO 5 WEEKS			
600	700	ELLIDH607010	734	2504	£866.00	£1,039.20	£1,082.50	£1,299.00
	920	ELLIDH609210	964	3289	£885.00	£1,062.00	£1,106.25	£1,327.50
	1820	ELLIDH601810	1907	6507	£1,046.00	£1,255.20	£1,307.50	£1,569.00
	2020	ELLIDH602010	2117	7223	£1,089.00	£1,306.80	£1,361.25	£1,633.50
	650	ELLIDH726512	818	2791	£937.00	£1,124.40	£1,171.25	£1,405.50
720	700	ELLIDH727012	881	3006	£976.00	£1,171.20	£1,220.00	£1,464.00
	920	ELLIDH729212	1158	3951	£1,017.00	£1,220.40	£1,271.25	£1,525.50
	1020	ELLIDH721012	1284	4381	£1,057.00	£1,268.40	£1,321.25	£1,585.50
	1220	ELLIDH721212	1536	5241	£1,129.00	£1,354.80	£1,411.25	£1,693.50
	1520	ELLIDH721512	1913	6527	£1,164.00	£1,396.80	£1,455.00	£1,746.00
	1820	ELLIDH721812	2291	7817	£1,249.00	£1,498.80	£1,561.25	£1,873.50
	2020	ELLIDH722012	2543	8677	£1,355.00	£1,626.00	£1,693.75	£2,032.50
900	650	ELLIDH906515	1023	3490	£1,107.00	£1,328.40	£1,383.75	£1,660.50
	700	ELLIDH907015	1101	3757	£1,158.00	£1,389.60	£1,447.50	£1,737.00
	920	ELLIDH909215	1448	4941	£1,198.00	£1,437.60	£1,497.50	£1,797.00
	1020	ELLIDH901015	1605	5476	£1,285.00	£1,542.00	£1,606.25	£1,927.50
	1220	ELLIDH901215	1920	6551	£1,408.00	£1,689.60	£1,760.00	£2,112.00
	1520	ELLIDH901515	2392	8162	£1,455.00	£1,746.00	£1,818.75	£2,182.50
	1820	ELLIDH901815	2864	9772	£1,560.00	£1,872.00	£1,950.00	£2,340.00
	2020	ELLIDH902015	3179	10847	£1,692.00	£2,030.40	£2,115.00	£2,538.00

*Saving based on the value of individual items when bought separately.
Order any of our selected valves & matching pipe covers at the same time as your radiator; PROMOV1W (white), PROMOV1C (chrome).

Ellipsis Single Vertical

shown on pages 54-55
High quality Italian design & manufacture.
Steel; 25mm x 50mm oval tubes. CE/UKCA approved & certified to BS EN442.

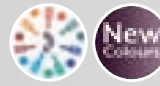

White RAL 9016 as standard, 188 RAL colours & 31 Special Finishes.
Please call **01342 302250** for a RAL or Special Finish chart.

6 NEW Feature Finishes (stock sizes only), see page 7 or call **01342 302250** for samples.
Colour Coordination Service available on stock sizes **see page 217** for full details.

Stock White RAL 9016 & Textured Anthracite: 48-72 Hours

Feature Finishes: Up to 2 weeks
Made to Order White, RALs & Special Finishes: Up to 5 weeks.

Pipe centres left to right	Pipe centres from wall	Depth from wall
width + valves	55mm	95mm

Ideal TRV & Pipe Covers



SAVE £45*

WHEN YOU BUY OUR IDEAL TRV & PIPE COVERS WITH ANY DESIGNER PURCHASE. QUOTE **PROMOVI** AT TIME OF ORDER.

Available in White or Chrome.

Stock options White RAL 9016 - Single Vertical

Please add 10% to the RAL/Special Finish price to work out your Feature Finish price

Height (mm)	Width (mm)	Model	Watts Δt 50°C	Btu's Δt 50°C	White Ex VAT	White Inc VAT	RALs & Special Finishes	
							Ex VAT	Inc VAT
DELIVERY TIMES							48-72 HOURS	
							UP TO 5 WEEKS	
1820	300	ELLISV183005	628	2143	£401.00	£481.20	£501.25	£601.50
	420	ELLISV184207	879	2999	£515.00	£618.00	£643.75	£772.50
	480	ELLISV184808	1004	3426	£560.00	£672.00	£700.00	£840.00
	600	ELLISV186010	1255	4282	£663.00	£795.60	£828.75	£994.50

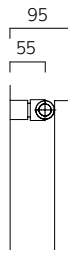

Stock options Textured Anthracite - Single Vertical

Height (mm)	Width (mm)	Model	Watts Δt 50°C	Btu's Δt 50°C	Textured Anthracite	
					Ex VAT	Inc VAT
DELIVERY TIMES					48-72 HOURS	
1820	480	ELLISV184808TA	1004	3426	£700.00	£840.00
	600	ELLISV186010TA	1255	4282	£828.75	£994.50

Made to order options - Single Vertical

Height (mm)	Width (mm)	Model	Watts Δt 50°C	Btu's Δt 50°C	White Ex VAT	White Inc VAT	RALs & Special Finishes	
							Ex VAT	Inc VAT
DELIVERY TIMES							UP TO 5 WEEKS	
							UP TO 5 WEEKS	
520	300	ELLISV523005	187	638	£340.00	£408.00	£425.00	£510.00
	480	ELLISV524808	298	1017	£479.00	£574.80	£598.75	£718.50
	540	ELLISV525409	336	1146	£509.00	£610.80	£636.25	£763.50
	600	ELLISV526010	373	1273	£540.00	£648.00	£675.00	£810.00
	720	ELLISV527212	448	1529	£645.00	£774.00	£806.25	£967.50
650	300	ELLISV653005	233	795	£360.00	£432.00	£450.00	£540.00
	480	ELLISV654808	372	1269	£502.00	£602.40	£627.50	£753.00
	540	ELLISV655409	419	1430	£531.00	£637.20	£663.75	£796.50
	600	ELLISV656010	465	1587	£568.00	£681.60	£710.00	£852.00
700	300	ELLISV703005	252	860	£361.00	£433.20	£451.25	£541.50
	480	ELLISV704808	402	1372	£503.00	£603.60	£628.75	£754.50
	540	ELLISV705409	453	1546	£540.00	£648.00	£675.00	£810.00
	600	ELLISV706010	503	1716	£578.00	£693.60	£722.50	£867.00
	720	ELLISV707212	604	2061	£690.00	£828.00	£862.50	£1,035.00
920	240	ELLISV922404	261	891	£293.00	£351.60	£366.25	£439.50
	300	ELLISV923005	327	1116	£362.00	£434.40	£452.50	£543.00
	480	ELLISV924808	522	1781	£505.00	£606.00	£631.25	£757.50
	540	ELLISV925409	588	2006	£545.00	£654.00	£681.25	£817.50
	600	ELLISV926010	653	2228	£586.00	£703.20	£732.50	£879.00
	720	ELLISV927212	784	2675	£708.00	£849.60	£885.00	£1,062.00
	840	ELLISV928414	914	3119	£842.00	£1,010.40	£1,052.50	£1,263.00
1020	240	ELLISV102404	288	983	£302.00	£362.40	£377.50	£453.00
	300	ELLISV103005	360	1228	£366.00	£439.20	£457.50	£549.00
	480	ELLISV104808	576	1965	£515.00	£618.00	£643.75	£772.50
	540	ELLISV105409	648	2211	£553.00	£663.60	£691.25	£829.50
	600	ELLISV106010	720	2457	£598.00	£717.60	£747.50	£897.00
	720	ELLISV107212	864	2948	£729.00	£874.80	£911.25	£1,093.50
840	ELLISV108414	1008	3439	£861.00	£1,033.20	£1,076.25	£1,291.50	

Height (mm)	Width (mm)	Model	Watts Δt 50°C	Btu's Δt 50°C	White Ex VAT	White Inc VAT	RALs & Special Finishes	
							Ex VAT	Inc VAT
DELIVERY TIMES							UP TO 5 WEEKS	
							UP TO 5 WEEKS	
1220	240	ELLISV122404	341	1163	£321.00	£385.20	£401.25	£481.50
	300	ELLISV123005	427	1457	£377.00	£452.40	£471.25	£565.50
	480	ELLISV124808	682	2327	£529.00	£634.80	£661.25	£793.50
	540	ELLISV125409	768	2620	£566.00	£679.20	£707.50	£849.00
	600	ELLISV126010	853	2910	£616.00	£739.20	£770.00	£924.00
	720	ELLISV127212	1024	3494	£746.00	£895.20	£932.50	£1,119.00
	840	ELLISV128414	1194	4074	£886.00	£1,063.20	£1,107.50	£1,329.00
1520	240	ELLISV152404	421	1436	£345.00	£414.00	£431.25	£517.50
	300	ELLISV153005	527	1798	£381.00	£457.20	£476.25	£571.50
	480	ELLISV154808	842	2873	£531.00	£637.20	£663.75	£796.50
	540	ELLISV155409	948	3235	£586.00	£703.20	£732.50	£879.00
	600	ELLISV156010	1053	3593	£633.00	£759.60	£791.25	£949.50
1820	240	ELLISV182404	502	1713	£365.00	£438.00	£456.25	£547.50
	540	ELLISV185409	1130	3856	£608.00	£729.60	£760.00	£912.00
	720	ELLISV187212	1506	5138	£804.00	£964.80	£1,005.00	£1,206.00
	840	ELLISV188414	1757	5995	£952.00	£1,142.40	£1,190.00	£1,428.00
2020	240	ELLISV202404	556	1897	£383.00	£459.60	£478.75	£574.50
	300	ELLISV203005	695	2371	£411.00	£493.20	£513.75	£616.50
	480	ELLISV204808	1112	3794	£571.00	£685.20	£713.75	£856.50
	540	ELLISV205409	1251	4268	£673.00	£807.60	£841.25	£1,009.50
	600	ELLISV206010	1390	4743	£686.00	£823.20	£857.50	£1,029.00
	720	ELLISV207212	1668	5691	£893.00	£1,071.60	£1,116.25	£1,339.50
	840	ELLISV208414	1946	6640	£1,057.00	£1,268.40	£1,321.25	£1,585.50

*Saving based on the value of individual items when bought separately.
Order any of our selected valves & matching pipe covers at the same time as your radiator; PROMOVIW (white), PROMOVI (chrome).

Ellipsis Double Vertical shown on pages 54-55

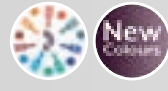

High quality Italian design & manufacture.

Steel; 25mm x 50mm oval tubes. CE/UKCA approved & certified to BS EN442.

White RAL 9016 as standard, 188 RAL colours & 31 Special Finishes.

Please call **01342 302250** for a RAL or Special Finish chart.

6 NEW Feature Finishes (stock sizes only), see page 7 or call **01342 302250** for samples.

Colour Coordination Service available on stock sizes see **page 217** for full details.



Stock White RAL 9016 & Textured Anthracite: 48-72 Hours

Feature Finishes: Up to 2 weeks

Made to Order White, RALs & Special Finishes: Up to 5 weeks.

Pipe centres left to right	Pipe centres from wall	Depth from wall
width + valves	80mm-90mm	120mm-130mm



SAVE £45*
WHEN YOU BUY OUR IDEAL TRV & PIPE COVERS WITH ANY DESIGNER PURCHASE. QUOTE PROMOV1 AT TIME OF ORDER.

Available in White or Chrome.

Stock options White RAL 9016 - Double Vertical

Please add 10% to the RAL/Special Finish price to work out your Feature Finish price

Height (mm)	Width (mm)	Model	Watts Δt 50°C	Btu's Δt 50°C	White Ex VAT	White Inc VAT	RALs & Special Finishes	
							Ex VAT	Inc VAT
DELIVERY TIMES					48-72 HOURS		UP TO 5 WEEKS	
1820	300	ELLIDV183005	951	3245	£644.00	£772.80	£805.00	£966.00
	420	ELLIDV184207	1331	4541	£750.00	£900.00	£937.50	£1,125.00
	480	ELLIDV184808	1521	5190	£847.00	£1,016.40	£1,058.75	£1,270.50
	600	ELLIDV186010	1901	6486	£1,046.00	£1,255.20	£1,307.50	£1,569.00

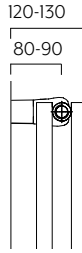

Stock options Textured Anthracite - Double Vertical

Height (mm)	Width (mm)	Model	Watts Δt 50°C	Btu's Δt 50°C	Textured Anthracite	
					Ex VAT	Inc VAT
DELIVERY TIMES					48-72 HOURS	
1820	480	ELLIDV184808TA	1521	5190	£1,058.75	£1,270.50
	600	ELLIDV186010TA	1901	6486	£1,307.50	£1,569.00

Made to order options - Double Vertical

Height (mm)	Width (mm)	Model	Watts Δt 50°C	Btu's Δt 50°C	White Ex VAT	White Inc VAT	RALs & Special Finishes	
							Ex VAT	Inc VAT
DELIVERY TIMES					UP TO 5 WEEKS		UP TO 5 WEEKS	
520	300	ELLIDV523005	288	983	£437.00	£524.40	£546.25	£655.50
	480	ELLIDV524808	460	1570	£631.00	£757.20	£788.75	£946.50
	540	ELLIDV525409	518	1767	£750.00	£900.00	£937.50	£1,125.00
	600	ELLIDV526010	575	1962	£792.00	£950.40	£990.00	£1,188.00
	720	ELLIDV527212	690	2354	£875.00	£1,050.00	£1,093.75	£1,312.50
650	300	ELLIDV653005	359	1225	£554.00	£664.80	£692.50	£831.00
	480	ELLIDV654808	574	1958	£737.00	£884.40	£921.25	£1,105.50
	540	ELLIDV655409	646	2204	£800.00	£960.00	£1,000.00	£1,200.00
	600	ELLIDV656010	718	2450	£852.00	£1,022.40	£1,065.00	£1,278.00
700	300	ELLIDV703005	387	1320	£564.00	£676.80	£705.00	£846.00
	480	ELLIDV704808	619	2112	£745.00	£894.00	£931.25	£1,117.50
	540	ELLIDV705409	697	2378	£810.00	£972.00	£1,012.50	£1,215.00
	600	ELLIDV706010	774	2641	£866.00	£1,039.20	£1,082.50	£1,299.00
	720	ELLIDV707212	929	3170	£976.00	£1,171.20	£1,220.00	£1,464.00
920	240	ELLIDV922404	402	1372	£433.00	£519.60	£541.25	£649.50
	300	ELLIDV923005	502	1713	£568.00	£681.60	£710.00	£852.00
	480	ELLIDV924808	803	2740	£754.00	£904.80	£942.50	£1,131.00
	540	ELLIDV925409	904	3084	£823.00	£987.60	£1,028.75	£1,234.50
	600	ELLIDV926010	1004	3426	£885.00	£1,062.00	£1,106.25	£1,327.50
	720	ELLIDV927212	1205	4111	£1,017.00	£1,220.40	£1,271.25	£1,525.50
	840	ELLIDV928414	1406	4797	£1,150.00	£1,380.00	£1,437.50	£1,725.00
1020	240	ELLIDV102404	441	1505	£456.00	£547.20	£570.00	£684.00
	300	ELLIDV103005	551	1880	£574.00	£688.80	£717.50	£861.00
	480	ELLIDV104808	882	3009	£764.00	£916.80	£955.00	£1,146.00
	540	ELLIDV105409	992	3385	£831.00	£997.20	£1,038.75	£1,246.50
	600	ELLIDV106010	1102	3760	£914.00	£1,096.80	£1,142.50	£1,371.00
	720	ELLIDV107212	1322	4511	£1,057.00	£1,268.40	£1,321.25	£1,585.50
	840	ELLIDV108414	1543	5265	£1,212.00	£1,454.40	£1,515.00	£1,818.00

Height (mm)	Width (mm)	Model	Watts Δt 50°C	Btu's Δt 50°C	White Ex VAT	White Inc VAT	RALs & Special Finishes	
							Ex VAT	Inc VAT
DELIVERY TIMES					UP TO 5 WEEKS		UP TO 5 WEEKS	
1220	240	ELLIDV122404	520	1774	£479.00	£574.80	£598.75	£718.50
	300	ELLIDV123005	651	2221	£591.00	£709.20	£738.75	£886.50
	480	ELLIDV124808	1041	3552	£784.00	£940.80	£980.00	£1,176.00
	540	ELLIDV125409	1171	3995	£857.00	£1,028.40	£1,071.25	£1,285.50
	600	ELLIDV126010	1301	4439	£949.00	£1,138.80	£1,186.25	£1,423.50
	720	ELLIDV127212	1561	5326	£1,129.00	£1,354.80	£1,411.25	£1,693.50
	840	ELLIDV128414	1821	6213	£1,314.00	£1,576.80	£1,642.50	£1,971.00
	1520	240	ELLIDV152404	641	2187	£483.00	£579.60	£603.75
300		ELLIDV153005	802	2736	£602.00	£722.40	£752.50	£903.00
480		ELLIDV154808	1282	4374	£809.00	£970.80	£1,011.25	£1,213.50
540		ELLIDV155409	1443	4924	£872.00	£1,046.40	£1,090.00	£1,308.00
600		ELLIDV156010	1603	5469	£969.00	£1,162.80	£1,211.25	£1,453.50
720		ELLIDV157212	1924	6565	£1,164.00	£1,396.80	£1,455.00	£1,746.00
840		ELLIDV158414	2244	7657	£1,358.00	£1,629.60	£1,697.50	£2,037.00
1820		240	ELLIDV182404	760	2593	£509.00	£610.80	£636.25
	540	ELLIDV185409	1711	5838	£941.00	£1,129.20	£1,176.25	£1,411.50
	720	ELLIDV187212	2281	7783	£1,249.00	£1,498.80	£1,561.25	£1,873.50
	840	ELLIDV188414	2661	9079	£1,455.00	£1,746.00	£1,818.75	£2,182.50
2020	240	ELLIDV202404	838	2859	£526.00	£631.20	£657.50	£789.00
	300	ELLIDV203005	1047	3572	£661.00	£793.20	£826.25	£991.50
	480	ELLIDV204808	1675	5715	£872.00	£1,046.40	£1,090.00	£1,308.00
	540	ELLIDV205409	1885	6432	£998.00	£1,197.60	£1,247.50	£1,497.00
	600	ELLIDV206010	2094	7145	£1,089.00	£1,306.80	£1,361.25	£1,633.50
	720	ELLIDV207212	2513	8574	£1,355.00	£1,626.00	£1,693.75	£2,032.50
	840	ELLIDV208414	2932	10004	£1,578.00	£1,893.60	£1,972.50	£2,367.00

*Saving based on the value of individual items when bought separately. Order any of our selected valves & matching pipe covers at the same time as your radiator; PROMOV1W (white), PROMOVIC (chrome).

Sitar Single Horizontal shown on pages 56-57



High quality Italian design & manufacture.

Steel; 23mm round tubes. CE/UKCA approved & certified to BS EN442.



White RAL 9016 as standard, 188 RAL colours & 31 Special Finishes.

Please call **01342 302250** for a RAL or Special Finish chart.

6 NEW Feature Finishes (stock sizes only), see page 7 or call **01342 302250** for samples.

Colour Coordination Service available on stock sizes see **page 217** for full details.

Stock White RAL 9016: 48-72 Hours.

Feature Finishes: Up to 2 weeks.

Made to Order White, RALs & Special Finishes: Up to 5 weeks.

Ideal TRV & Pipe Covers

SAVE £45*
WHEN YOU BUY OUR IDEAL TRV & PIPE COVERS WITH ANY DESIGNER PURCHASE. QUOTE **PROMOVI** AT TIME OF ORDER.

Available in White or Chrome.

Pipe centres left to right	Pipe centres from wall	Depth from wall
width - 50mm	55mm	90mm

Stock options White RAL 9016 - Single Horizontal

Please add 10% to the RAL/Special Finish price to work out your Feature Finish price

Height (mm)	Width (mm)	Model	Watts Δt 50°C	Btu's Δt 50°C	White		RALs & Special Finishes	
					Ex VAT	Inc VAT	Ex VAT	Inc VAT
DELIVERY TIMES					48-72 HOURS		UP TO 5 WEEKS	
402	920	SITASH409212	515	1757	£401.00	£481.20	£501.25	£601.50
	1220	SITASH401212	683	2330	£423.00	£507.60	£528.75	£634.50
	1520	SITASH401512	851	2904	£440.00	£528.00	£550.00	£660.00
504	520	SITASH505215	361	1232	£409.00	£490.80	£511.25	£613.50
	650	SITASH506515	451	1539	£419.00	£502.80	£523.75	£628.50
	700	SITASH507015	486	1658	£428.00	£513.60	£535.00	£642.00
	920	SITASH509215	639	2180	£443.00	£531.60	£553.75	£664.50
	1220	SITASH501215	848	2893	£468.00	£561.60	£585.00	£702.00
538	1520	SITASH501515	1056	3603	£487.00	£584.40	£608.75	£730.50
	920	SITASH539216	681	2324	£456.00	£547.20	£570.00	£684.00
	1220	SITASH531216	903	3081	£482.00	£578.40	£602.50	£723.00
606	1520	SITASH531516	1124	3835	£505.00	£606.00	£631.25	£757.50
	650	SITASH606518	537	1832	£456.00	£547.20	£570.00	£684.00
	700	SITASH607018	578	1972	£471.00	£565.20	£588.75	£706.50
	920	SITASH609218	760	2593	£491.00	£589.20	£613.75	£736.50
	1220	SITASH601218	1009	3443	£515.00	£618.00	£643.75	£772.50
1520	SITASH601518	1257	4289	£539.00	£646.80	£673.75	£808.50	

Feature Finishes (for stock sizes)

Please see page 7 for details or call customer services for sample swatches.

To work out your Feature Finish price please add 10% to the RAL/Special Finish colour price shown in the pricing tables.

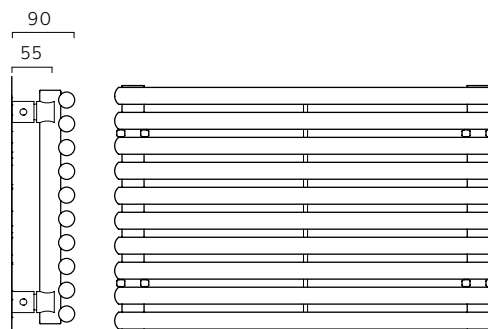

Made to order options - Single Horizontal

Height (mm)	Width (mm)	Model	Watts Δt 50°C	Btu's Δt 50°C	White		RALs & Special Finishes		Height (mm)	Width (mm)	Model	Watts Δt 50°C	Btu's Δt 50°C	White		RALs & Special Finishes		
					Ex VAT	Inc VAT	Ex VAT	Inc VAT						Ex VAT	Inc VAT	Ex VAT	Inc VAT	
DELIVERY TIMES					UP TO 5 WEEKS		UP TO 5 WEEKS		DELIVERY TIMES					UP TO 5 WEEKS		UP TO 5 WEEKS		
300	520	SITASH305209	218	744	£338.00	£405.60	£422.50	£507.00	606	1820	SITASH601818	1505	5135	£562.00	£674.40	£702.50	£843.00	
	650	SITASH306509	272	928	£345.00	£414.00	£431.25	£517.50		2020	SITASH602018	1670	5698	£578.00	£693.60	£722.50	£867.00	
	700	SITASH307009	293	1000	£352.00	£422.40	£440.00	£528.00		708	650	SITASH706521	620	2115	£490.00	£588.00	£612.50	£735.00
	920	SITASH309209	386	1317	£362.00	£434.40	£452.50	£543.00			700	SITASH707021	667	2276	£503.00	£603.60	£628.75	£754.50
	1220	SITASH301209	512	1747	£377.00	£452.40	£471.25	£565.50			920	SITASH709221	877	2992	£526.00	£631.20	£657.50	£789.00
	1520	SITASH301509	638	2177	£391.00	£469.20	£488.75	£586.50			1220	SITASH701221	1164	3972	£557.00	£668.40	£696.25	£835.50
	1820	SITASH301809	764	2607	£403.00	£483.60	£503.75	£604.50			1520	SITASH701521	1450	4947	£587.00	£704.40	£733.75	£880.50
	2020	SITASH302009	848	2893	£411.00	£493.20	£513.75	£616.50			1820	SITASH701821	1736	5923	£614.00	£736.80	£767.50	£921.00
402	520	SITASH405212	291	993	£371.00	£445.20	£463.75	£556.50	2020	SITASH702021	1927	6575	£631.00	£757.20	£788.75	£946.50		
	650	SITASH406512	363	1239	£380.00	£456.00	£475.00	£570.00	810	650	SITASH816524	700	2388	£526.00	£631.20	£657.50	£789.00	
	700	SITASH407012	391	1334	£386.00	£463.20	£482.50	£579.00		700	SITASH817024	754	2573	£540.00	£648.00	£675.00	£810.00	
	1820	SITASH401812	1018	3473	£456.00	£547.20	£570.00	£684.00		920	SITASH819224	991	3381	£564.00	£676.80	£705.00	£846.00	
	2020	SITASH402012	1130	3856	£468.00	£561.60	£585.00	£702.00		1220	SITASH811224	1314	4483	£600.00	£720.00	£750.00	£900.00	
504	1820	SITASH501815	1265	4316	£509.00	£610.80	£636.25	£763.50		1520	SITASH811524	1637	5585	£633.00	£759.60	£791.25	£949.50	
	2020	SITASH502015	1404	4790	£524.00	£628.80	£655.00	£786.00	1820	SITASH811824	1961	6691	£666.00	£799.20	£832.50	£999.00		
									2020	SITASH812024	2176	7425	£689.00	£826.80	£861.25	£1,033.50		

*Saving based on the value of individual items when bought separately. Order any of our selected valves & matching pipe covers at the same time as your radiator; PROMOVIW (white), PROMOVIC (chrome).

Sitar Double Horizontal shown on pages 56-57

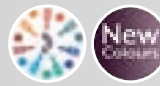

High quality Italian design & manufacture.

Steel; 23mm round tubes. CE/UKCA approved & certified to BS EN442.

White RAL 9016 as standard, 188 RAL colours & 31 Special Finishes.

Please call **01342 302250** for a RAL or Special Finish chart.

6 NEW Feature Finishes (stock sizes only), see page 7 or call **01342 302250** for samples.

Colour Coordination Service available on stock sizes **see page 217** for full details.

Stock White RAL 9016: 48-72 Hours.

Feature Finishes: Up to 2 weeks.

Made to Order White, RALs & Special Finishes: Up to 5 weeks.



Ideal TRV & Pipe Covers



SAVE £45*
WHEN YOU BUY OUR IDEAL TRV & PIPE COVERS WITH ANY DESIGNER PURCHASE. QUOTE PROMOV1 AT TIME OF ORDER.

Available in White or Chrome.

Pipe centres left to right	Pipe centres from wall	Depth from wall
width - 50mm	79mm to 89mm	114mm to 124mm

Stock options White RAL 9016 - Double Horizontal

Please add 10% to the RAL/Special Finish price to work out your Feature Finish price

Height (mm)	Width (mm)	Model	Watts Δt 50°C	Btu's Δt 50°C	RALs & Special Finishes			
					White Ex VAT	White Inc VAT	Ex VAT	Inc VAT
DELIVERY TIMES					48-72 HOURS		UP TO 5 WEEKS	
402	920	SITADH409212	782	2668	£628.00	£753.60	£785.00	£942.00
	1220	SITADH401212	1037	3538	£666.00	£799.20	£832.50	£999.00
	1520	SITADH401512	1292	4408	£703.00	£843.60	£878.75	£1,054.50
	1820	SITADH401812	1547	5278	£731.00	£877.20	£913.75	£1,096.50
504	520	SITADH505215	527	1798	£651.00	£781.20	£813.75	£976.50
	650	SITADH506515	658	2245	£660.00	£792.00	£825.00	£990.00
	700	SITADH507015	709	2419	£673.00	£807.60	£841.25	£1,009.50
	920	SITADH509215	937	3197	£690.00	£828.00	£862.50	£1,035.00
	1220	SITADH501215	1235	4214	£737.00	£884.40	£921.25	£1,105.50
	1520	SITADH501515	1540	5254	£781.00	£937.20	£976.25	£1,171.50
538	1820	SITADH501815	1844	6292	£812.00	£974.40	£1,015.00	£1,218.00
	920	SITADH539216	955	3258	£710.00	£852.00	£887.50	£1,065.00
	1220	SITADH531216	1266	4320	£760.00	£912.00	£950.00	£1,140.00
538	1520	SITADH531516	1577	5381	£807.00	£968.40	£1,008.75	£1,210.50
	606	650	SITADH606518	732	2498	£715.00	£858.00	£893.75
700		SITADH607018	789	2692	£730.00	£876.00	£912.50	£1,095.00
920		SITADH609218	1037	3538	£754.00	£904.80	£942.50	£1,131.00
1220		SITADH601218	1375	4692	£807.00	£968.40	£1,008.75	£1,210.50
1520		SITADH601518	1713	5845	£860.00	£1,032.00	£1,075.00	£1,290.00
606	1820	SITADH601818	2051	6998	£897.00	£1,076.40	£1,121.25	£1,345.50

Feature Finishes (for stock sizes)

Please see page 7 for details or call customer services for sample swatches.

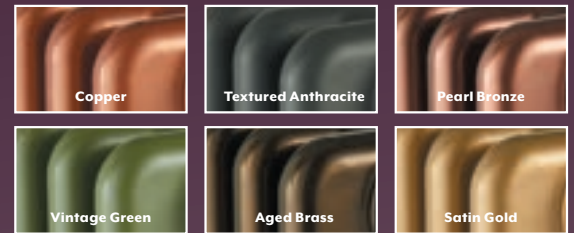

To work out your Feature Finish price please add 10% to the RAL/Special Finish colour price shown in the pricing tables.

Double

114-124
79-89

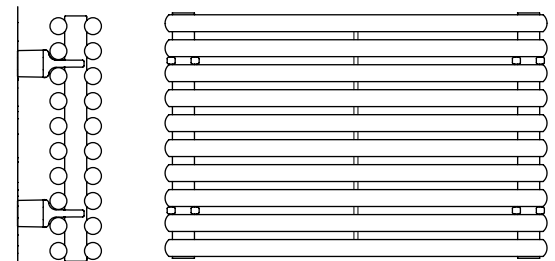

Made to order options - Double Horizontal

Height (mm)	Width (mm)	Model	Watts Δt 50°C	Btu's Δt 50°C	RALs & Special Finishes				
					White Ex VAT	White Inc VAT	Ex VAT	Inc VAT	
DELIVERY TIMES					UP TO 5 WEEKS		UP TO 5 WEEKS		
300	520	SITADH305209	378	1290	£540.00	£648.00	£675.00	£810.00	
	650	SITADH306509	473	1614	£545.00	£654.00	£681.25	£817.50	
	700	SITADH307009	509	1737	£553.00	£663.60	£691.25	£829.50	
	920	SITADH309209	669	2283	£572.00	£686.40	£715.00	£858.00	
	1220	SITADH301209	887	3026	£599.00	£718.80	£748.75	£898.50	
	1520	SITADH301509	1105	3770	£625.00	£750.00	£781.25	£937.50	
	1820	SITADH301809	1323	4514	£645.00	£774.00	£806.25	£967.50	
	2020	SITADH302009	1468	5009	£656.00	£787.20	£820.00	£984.00	
	402	520	SITADH405212	442	1508	£596.00	£715.20	£745.00	£894.00
650		SITADH406512	552	1883	£601.00	£721.20	£751.25	£901.50	
700		SITADH407012	595	2030	£610.00	£732.00	£762.50	£915.00	
2020		SITADH402012	1717	5858	£745.00	£894.00	£931.25	£1,117.50	
504	2020	SITADH502015	2046	6981	£835.00	£1,002.00	£1,043.75	£1,252.50	
606	2020	SITADH602018	2276	7766	£924.00	£1,108.80	£1,155.00	£1,386.00	
708	650	SITADH706521	829	2829	£774.00	£928.80	£967.50	£1,161.00	
	700	SITADH707021	893	3047	£790.00	£948.00	£987.50	£1,185.00	
	920	SITADH709221	1174	4006	£816.00	£979.20	£1,020.00	£1,224.00	
	1220	SITADH701221	1556	5309	£878.00	£1,053.60	£1,097.50	£1,317.00	
	1520	SITADH701521	1939	6616	£938.00	£1,125.60	£1,172.50	£1,407.00	
	1820	SITADH701821	2322	7923	£980.00	£1,176.00	£1,225.00	£1,470.00	
	2020	SITADH702021	2577	8793	£1,012.00	£1,214.40	£1,265.00	£1,518.00	
	810	650	SITADH816524	901	3074	£831.00	£997.20	£1,038.75	£1,246.50
		700	SITADH817024	970	3310	£851.00	£1,021.20	£1,063.75	£1,276.50
		920	SITADH819224	1275	4350	£882.00	£1,058.40	£1,102.50	£1,323.00
1220		SITADH811224	1691	5770	£950.00	£1,140.00	£1,187.50	£1,425.00	
1520		SITADH811524	2107	7189	£1,014.00	£1,216.80	£1,267.50	£1,521.00	
1820		SITADH811824	2523	8608	£1,066.00	£1,279.20	£1,332.50	£1,599.00	
2020		SITADH812024	2800	9554	£1,098.00	£1,317.60	£1,372.50	£1,647.00	

*Saving based on the value of individual items when bought separately. Order any of our selected valves & matching pipe covers at the same time as your radiator; PROMOVIV (white), PROMOVIC (chrome).

Sitar Single Vertical shown on pages 56-57



High quality Italian design & manufacture.
Steel; 23mm round tubes. CE/UKCA approved & certified to BS EN442.

White RAL 9016 as standard, 188 RAL colours & 31 Special Finishes.
Please call **01342 302250** for a RAL or Special Finish chart.
6 NEW Feature Finishes (stock sizes only), see page 7 or call **01342 302250** for samples.
Colour Coordination Service available on stock sizes **see page 217** for full details.

Stock White RAL 9016: 48-72 Hours.
Feature Finishes: Up to 2 weeks.
Made to Order White, RALs & Special Finishes: Up to 5 weeks.



SAVE £45*
WHEN YOU BUY OUR IDEAL TRV & PIPE COVERS WITH ANY DESIGNER PURCHASE. QUOTE PROMOV1 AT TIME OF ORDER.



Available in White or Chrome.

Pipe centres left to right	Pipe centres from wall	Depth from wall
width + valves	55mm	90mm

Stock options White RAL 9016 - Single Vertical

Please add 10% to the RAL/Special Finish price to work out your Feature Finish price

Height (mm)	Width (mm)	Model	Watts Δt 50°C	Btu's Δt 50°C	White		RALs & Special Finishes	
					Ex VAT	Inc VAT	Ex VAT	Inc VAT
DELIVERY TIMES					48-72 HOURS		UP TO 5 WEEKS	
650	402	SITASV654012	384	1310	£380.00	£456.00	£475.00	£570.00
	504	SITASV655015	480	1638	£419.00	£502.80	£523.75	£628.50
1220	402	SITASV124012	660	2252	£423.00	£507.60	£528.75	£634.50
	504	SITASV125015	825	2815	£468.00	£561.60	£585.00	£702.00
1520	606	SITASV126018	990	3378	£515.00	£618.00	£643.75	£772.50
	232	SITASV152307	469	1600	£360.00	£432.00	£450.00	£540.00
	300	SITASV153009	603	2057	£391.00	£469.20	£488.75	£586.50
	402	SITASV154012	804	2743	£440.00	£528.00	£550.00	£660.00
1820	504	SITASV155015	1005	3429	£487.00	£584.40	£608.75	£730.50
	606	SITASV156018	1206	4115	£539.00	£646.80	£673.75	£808.50
	232	SITASV182307	546	1863	£367.00	£440.40	£458.75	£550.50
	300	SITASV183009	702	2395	£403.00	£483.60	£503.75	£604.50
2020	402	SITASV184012	936	3194	£456.00	£547.20	£570.00	£684.00
	504	SITASV185015	1170	3992	£509.00	£610.80	£636.25	£763.50
	606	SITASV186018	1404	4790	£562.00	£674.40	£702.50	£843.00
2020	708	SITASV187021	1638	5589	£614.00	£736.80	£767.50	£921.00
	402	SITASV204012	1032	3521	£468.00	£561.60	£585.00	£702.00
	504	SITASV205015	1290	4401	£524.00	£628.80	£655.00	£786.00
606	SITASV206018	1548	5282	£578.00	£693.60	£722.50	£867.00	

Single

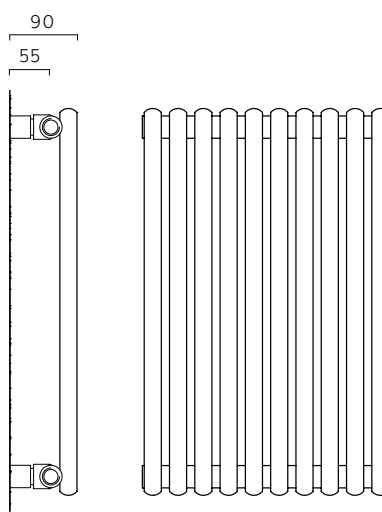

Underneath Connections	Ex VAT	Inc VAT
B2CONN	£161.00	£193.20
Underneath Connections are made to order only, stock lines are BOE.		
Underneath Connections pipe centres = width - 75mm		

Made to order options - Single Vertical

Height (mm)	Width (mm)	Model	Watts Δt 50°C	Btu's Δt 50°C	White		RALs & Special Finishes	
					Ex VAT	Inc VAT	Ex VAT	Inc VAT
DELIVERY TIMES					UP TO 5 WEEKS		UP TO 5 WEEKS	
520	300	SITASV523009	234	798	£338.00	£405.60	£422.50	£507.00
	402	SITASV524012	312	1065	£371.00	£445.20	£463.75	£556.50
	504	SITASV525015	390	1331	£409.00	£490.80	£511.25	£613.50
	606	SITASV526018	468	1597	£443.00	£531.60	£553.75	£664.50
	708	SITASV527021	546	1863	£477.00	£572.40	£596.25	£715.50
650	300	SITASV653009	288	983	£345.00	£414.00	£431.25	£517.50
	606	SITASV656018	576	1965	£456.00	£547.20	£570.00	£684.00
	708	SITASV657021	672	2293	£490.00	£588.00	£612.50	£735.00
750	300	SITASV753009	324	1105	£355.00	£426.00	£443.75	£532.50
	402	SITASV754012	432	1474	£389.00	£466.80	£486.25	£583.50
	504	SITASV755015	540	1842	£433.00	£519.60	£541.25	£649.50
	606	SITASV756018	648	2211	£479.00	£574.80	£598.75	£718.50
920	708	SITASV757021	756	2579	£513.00	£615.60	£641.25	£769.50
	232	SITASV922307	301	1027	£337.00	£404.40	£421.25	£505.50
	300	SITASV923009	387	1320	£362.00	£434.40	£452.50	£543.00
402	SITASV924012	516	1761	£401.00	£481.20	£501.25	£601.50	

Height (mm)	Width (mm)	Model	Watts Δt 50°C	Btu's Δt 50°C	White		RALs & Special Finishes	
					Ex VAT	Inc VAT	Ex VAT	Inc VAT
DELIVERY TIMES					UP TO 5 WEEKS		UP TO 5 WEEKS	
920	504	SITASV925015	645	2201	£443.00	£531.60	£553.75	£664.50
	606	SITASV926018	774	2641	£491.00	£589.20	£613.75	£736.50
	708	SITASV927021	903	3081	£526.00	£631.20	£657.50	£789.00
	810	SITASV928124	1032	3521	£564.00	£676.80	£705.00	£846.00
1220	232	SITASV122307	385	1314	£346.00	£415.20	£432.50	£519.00
	300	SITASV123009	495	1689	£377.00	£452.40	£471.25	£565.50
	708	SITASV127021	1155	3941	£557.00	£668.40	£696.25	£835.50
1520	810	SITASV128124	1320	4504	£600.00	£720.00	£750.00	£900.00
	708	SITASV157021	1407	4801	£587.00	£704.40	£733.75	£880.50
1820	810	SITASV158124	1608	5486	£633.00	£759.60	£791.25	£949.50
	810	SITASV188124	1872	6387	£666.00	£799.20	£832.50	£999.00
2020	232	SITASV202307	602	2054	£376.00	£451.20	£470.00	£564.00
	300	SITASV203009	774	2641	£411.00	£493.20	£513.75	£616.50
	708	SITASV207021	1806	6162	£631.00	£757.20	£788.75	£946.50
810	SITASV208124	2064	7042	£689.00	£826.80	£861.25	£1,033.50	

*Saving based on the value of individual items when bought separately. Order any of our selected valves & matching pipe covers at the same time as your radiator; PROMOV1W (white), PROMOV1C (chrome).

Sitar Double Vertical shown on pages 56-57

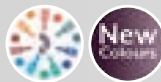

High quality Italian design & manufacture.

Steel; 23mm round tubes. CE/UKCA approved & certified to BS EN442.

White RAL 9016 as standard, 188 RAL colours & 31 Special Finishes.

Please call **01342 302250** for a RAL or Special Finish chart.

6 NEW Feature Finishes (stock sizes only), see page 7 or call **01342 302250** for samples.

Colour Coordination Service available on stock sizes **see page 217** for full details.



Stock White RAL 9016: 48-72 Hours.

Feature Finishes: Up to 2 weeks.

Made to Order White, RALs & Special Finishes: Up to 5 weeks.

Pipe centres left to right	Pipe centres from wall	Depth from wall
width + valves	79mm to 89mm	114mm to 124mm

Stock options White RAL 9016 - Double Vertical

Please add 10% to the RAL/Special Finish price to work out your Feature Finish price

Height (mm)	Width (mm)	Model	Watts Δt 50°C	Btu's Δt 50°C	White Ex VAT	White Inc VAT	RALs & Special Finishes	
							Ex VAT	Inc VAT
DELIVERY TIMES				48-72 HOURS		UP TO 5 WEEKS		
650	402	SITADV654012	576	1965	£601.00	£721.20	£751.25	£901.50
	504	SITADV655015	720	2457	£660.00	£792.00	£825.00	£990.00
1220	402	SITADV124012	960	3276	£666.00	£799.20	£832.50	£999.00
	504	SITADV125015	1200	4094	£737.00	£884.40	£921.25	£1,105.50
1520	232	SITADV152307	686	2341	£572.00	£686.40	£715.00	£858.00
	300	SITADV153009	882	3009	£625.00	£750.00	£781.25	£937.50
	402	SITADV154012	1176	4013	£703.00	£843.60	£878.75	£1,054.50
	504	SITADV155015	1470	5016	£781.00	£937.20	£976.25	£1,171.50
1820	606	SITADV156018	1764	6019	£860.00	£1,032.00	£1,075.00	£1,290.00
	232	SITADV182307	819	2794	£587.00	£704.40	£733.75	£880.50
	300	SITADV183009	1053	3593	£645.00	£774.00	£806.25	£967.50
	402	SITADV184012	1404	4790	£731.00	£877.20	£913.75	£1,096.50
	504	SITADV185015	1755	5988	£812.00	£974.40	£1,015.00	£1,218.00
2020	606	SITADV186018	2106	7186	£897.00	£1,076.40	£1,121.25	£1,345.50
	708	SITADV187021	2457	8383	£980.00	£1,176.00	£1,225.00	£1,470.00
2020	402	SITADV204012	1572	5364	£745.00	£894.00	£931.25	£1,117.50
	504	SITADV205015	1965	6705	£835.00	£1,002.00	£1,043.75	£1,252.50
	606	SITADV206018	2358	8045	£924.00	£1,108.80	£1,155.00	£1,386.00

Ideal TRV & Pipe Covers

SAVE £45*
WHEN YOU BUY OUR IDEAL TRV & PIPE COVERS WITH ANY DESIGNER PURCHASE. QUOTE PROMOV1 AT TIME OF ORDER.

Double

114-124
79-89

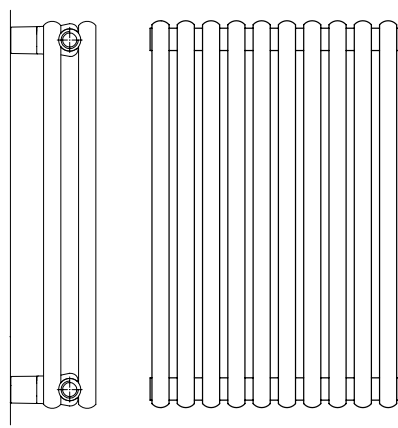

Underneath Connections	Ex VAT	Inc VAT
B2CONN	£161.00	£193.20
Underneath Connections are made to order only, stock lines are BOE.		
Underneath Connections pipe centres = width - 75mm		

Made to order options - Double Vertical

Height (mm)	Width (mm)	Model	Watts Δt 50°C	Btu's Δt 50°C	White Ex VAT	White Inc VAT	RALs & Special Finishes	
							Ex VAT	Inc VAT
DELIVERY TIMES				UP TO 5 WEEKS		UP TO 5 WEEKS		
520	300	SITADV523009	360	1228	£540.00	£648.00	£675.00	£810.00
	402	SITADV524012	480	1638	£596.00	£715.20	£745.00	£894.00
	504	SITADV525015	600	2047	£651.00	£781.20	£813.75	£976.50
	606	SITADV526018	720	2457	£707.00	£848.40	£883.75	£1,060.50
	708	SITADV527021	840	2866	£761.00	£913.20	£951.25	£1,141.50
650	300	SITADV653009	432	1474	£545.00	£654.00	£681.25	£817.50
	606	SITADV656018	864	2948	£715.00	£858.00	£893.75	£1,072.50
	708	SITADV657021	1008	3439	£774.00	£928.80	£967.50	£1,161.00
750	300	SITADV753009	477	1628	£560.00	£672.00	£700.00	£840.00
	402	SITADV754012	636	2170	£613.00	£735.60	£766.25	£919.50
	504	SITADV755015	795	2713	£678.00	£813.60	£847.50	£1,017.00
	606	SITADV756018	954	3255	£733.00	£879.60	£916.25	£1,099.50
920	708	SITADV757021	1113	3798	£796.00	£955.20	£995.00	£1,194.00
	232	SITADV922307	441	1505	£532.00	£638.40	£665.00	£798.00
	300	SITADV923009	567	1935	£572.00	£686.40	£715.00	£858.00
	402	SITADV924012	756	2579	£628.00	£753.60	£785.00	£942.00

Height (mm)	Width (mm)	Model	Watts Δt 50°C	Btu's Δt 50°C	White Ex VAT	White Inc VAT	RALs & Special Finishes	
							Ex VAT	Inc VAT
DELIVERY TIMES				UP TO 5 WEEKS		UP TO 5 WEEKS		
920	504	SITADV925015	945	3224	£675.00	£810.00	£843.75	£1,012.50
	606	SITADV926018	1134	3869	£742.00	£890.40	£927.50	£1,113.00
	708	SITADV927021	1323	4514	£801.00	£961.20	£1,001.25	£1,201.50
	810	SITADV928124	1512	5159	£866.00	£1,039.20	£1,082.50	£1,299.00
1220	232	SITADV122307	560	1911	£552.00	£662.40	£690.00	£828.00
	300	SITADV123009	720	2457	£599.00	£718.80	£748.75	£898.50
	606	SITADV126018	1440	4913	£807.00	£968.40	£1,008.75	£1,210.50
	708	SITADV127021	1680	5732	£878.00	£1,053.60	£1,097.50	£1,317.00
1520	810	SITADV128124	1920	6551	£950.00	£1,140.00	£1,187.50	£1,425.00
	708	SITADV157021	2058	7022	£938.00	£1,125.60	£1,172.50	£1,407.00
1820	810	SITADV158124	2352	8025	£1,014.00	£1,216.80	£1,267.50	£1,521.00
	810	SITADV188124	2808	9581	£1,066.00	£1,279.20	£1,332.50	£1,599.00
2020	232	SITADV202307	917	3129	£599.00	£718.80	£748.75	£898.50
	300	SITADV203009	1179	4023	£656.00	£787.20	£820.00	£984.00
	708	SITADV207021	2751	9386	£1,012.00	£1,214.40	£1,265.00	£1,518.00
	810	SITADV208124	3144	10727	£1,098.00	£1,317.60	£1,372.50	£1,647.00

*Saving based on the value of individual items when bought separately. Order any of our selected valves & matching pipe covers at the same time as your radiator; PROMOV1W (white), PROMOVIC (chrome).

Sax[®] Horizontal shown on pages 58-59



High quality Italian design & manufacture.
Steel; 20mm x 25mm tubes with 30mm collectors
CE/UKCA approved & certified to BS EN442.



White RAL 9016 as standard, 188 RAL colours & 31 Special Finishes.
Please call **01342 302250** for a RAL or Special Finish chart.
6 NEW Feature Finishes (stock sizes only), see page 7 or call **01342 302250** for samples.
Colour Coordination Service available on stock sizes **see page 217** for full details.



Stock White RAL 9016: 48-72 Hours. Feature Finishes: Up to 2 weeks.
Made to Order White, RALs & Special Finishes: Up to 5 weeks.

New Electric sizes available see pages 35/150 for details

Ideal TRV & Pipe Covers



SAVE £45*
WHEN YOU BUY OUR IDEAL TRV & PIPE COVERS WITH ANY DESIGNER PURCHASE. QUOTE PROMOV1 AT TIME OF ORDER.

Available in White or Chrome.

Stock options White RAL 9016 - Single Horizontal

Please add 10% to the RAL/Special Finish price to work out your Feature Finish price

Height (mm)	Width (mm)	Model	Watts Δt50°C	Btu's Δt50°C	White Ex VAT	White Inc VAT	RALs & Special Finishes	
							Ex VAT	Inc VAT
DELIVERY TIMES					48-72 HOURS		UP TO 5 WEEKS	
520	1200	SAXSH521213	799	2726	£630.00	£756.00	£787.50	£945.00
600	900	SAXSH609015	686	2341	£632.00	£758.40	£790.00	£948.00
	1200	SAXSH601215	915	3122	£671.00	£805.20	£838.75	£1,006.50

Pipe centres left to right	Pipe centres from wall	Depth from wall
width - 30mm	55mm	95mm

Made to order options - Single Horizontal

Height (mm)	Width (mm)	Model	Watts Δt 50°C	Btu's Δt 50°C	White Ex VAT	White Inc VAT	RALs & Special Finishes	
							Ex VAT	Inc VAT
DELIVERY TIMES					UP TO 5 WEEKS		UP TO 5 WEEKS	
400	900	SAXSH409010	465	1587	£521.00	£625.20	£651.25	£781.50
	1200	SAXSH401210	621	2119	£545.00	£654.00	£681.25	£817.50
	1500	SAXSH401510	776	2648	£572.00	£686.40	£715.00	£858.00
	1800	SAXSH401810	931	3177	£593.00	£711.60	£741.25	£889.50
520	900	SAXSH529013	599	2044	£593.00	£711.60	£741.25	£889.50
	1500	SAXSH521513	999	3409	£663.00	£795.60	£828.75	£994.50
	1800	SAXSH521813	1199	4091	£689.00	£826.80	£861.25	£1,033.50
600	1500	SAXSH601515	1144	3903	£709.00	£850.80	£886.25	£1,063.50
	1800	SAXSH601815	1373	4685	£743.00	£891.60	£928.75	£1,114.50

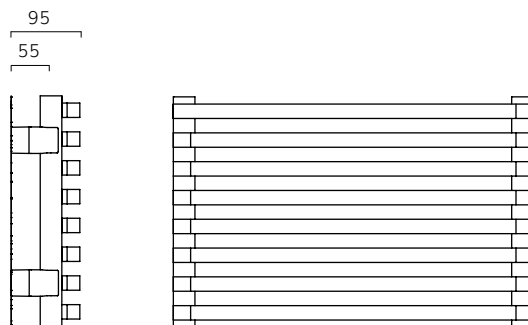

Stock options White RAL 9016 - Double Horizontal

Please add 10% to the RAL/Special Finish price to work out your Feature Finish price

Height (mm)	Width (mm)	Model	Watts Δt 50°C	Btu's Δt 50°C	White Ex VAT	White Inc VAT	RALs & Special Finishes	
							Ex VAT	Inc VAT
DELIVERY TIMES					48-72 HOURS		UP TO 5 WEEKS	
520	1200	SAXDH521213	1272	4340	£1,170.00	£1,404.00	£1,462.50	£1,755.00
600	900	SAXDH609015	1066	3637	£1,189.00	£1,426.80	£1,486.25	£1,783.50
	1200	SAXDH601215	1422	4852	£1,250.00	£1,500.00	£1,562.50	£1,875.00

Pipe centres left to right	Pipe centres from wall	Depth from wall
width - 30mm	76mm to 82mm	116mm to 122mm

Made to order options - Double Horizontal

Height (mm)	Width (mm)	Model	Watts Δt 50°C	Btu's Δt 50°C	White Ex VAT	White Inc VAT	RALs & Special Finishes	
							Ex VAT	Inc VAT
DELIVERY TIMES					UP TO 5 WEEKS		UP TO 5 WEEKS	
400	900	SAXDH409010	777	2651	£974.00	£1,168.80	£1,217.50	£1,461.00
	1200	SAXDH401210	1036	3535	£1,014.00	£1,216.80	£1,267.50	£1,521.00
	1500	SAXDH401510	1295	4419	£1,056.00	£1,267.20	£1,320.00	£1,584.00
	1800	SAXDH401810	1554	5302	£1,131.00	£1,357.20	£1,413.75	£1,696.50
520	900	SAXDH529013	954	3255	£1,115.00	£1,338.00	£1,393.75	£1,672.50
	1500	SAXDH521513	1591	5428	£1,224.00	£1,468.80	£1,530.00	£1,836.00
	1800	SAXDH521813	1909	6514	£1,310.00	£1,572.00	£1,637.50	£1,965.00
600	1500	SAXDH601515	1777	6063	£1,310.00	£1,572.00	£1,637.50	£1,965.00
	1800	SAXDH601815	2133	7278	£1,401.00	£1,681.20	£1,751.25	£2,101.50

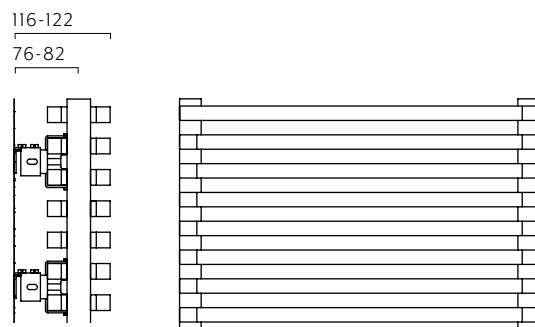

*Sax is an IRSAP Group registered design

*Saving based on the value of individual items when bought separately.

Order any of our selected valves & matching pipe covers at the same time as your radiator; PROMOV1W (white), PROMOV1C (chrome).

Sax® Vertical shown on pages 58-59

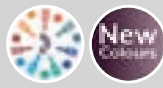

High quality Italian design & manufacture.
Steel; 20mm x 25mm tubes with 30mm collectors
CE/UKCA approved & certified to BS EN442.



White RAL 9016 as standard, 188 RAL colours & 31 Special Finishes.
Please call **01342 302250** for a RAL or Special Finish chart.

6 NEW Feature Finishes (stock sizes only), see page 7 or call **01342 302250** for samples.
Colour Coordination Service available on stock sizes **see page 217** for full details.



Stock White RAL 9016: 48-72 Hours. Feature Finishes: Up to 2 weeks.
Made to Order White, RALs & Special Finishes: Up to 5 weeks.

Stock options White RAL 9016 - Single Vertical

Please add 10% to the RAL/Special Finish price to work out your Feature Finish price

Height (mm)	Width (mm)	Model	Watts Δt 50°C	Btu's Δt 50°C	White Ex VAT	White Inc VAT	RALs & Special Finishes Ex VAT	RALs & Special Finishes Inc VAT
DELIVERY TIMES			48-72 HOURS		UP TO 5 WEEKS			
1800	400	SAXSV184010	861	2938	£593.00	£711.60	£741.25	£889.50
	520	SAXSV185213	1119	3818	£689.00	£826.80	£861.25	£1,033.50

Ideal TRV & Pipe Covers



SAVE £45*

WHEN YOU BUY OUR IDEAL TRV & PIPE COVERS WITH ANY DESIGNER PURCHASE. QUOTE PROMOV1 AT TIME OF ORDER.

Available in White or Chrome.



Pipe centres left to right	Pipe centres from wall	Depth from wall
width + valves	55mm	95mm

*Sax is an IRSAP Group registered design

Made to order options - Single Vertical

Height (mm)	Width (mm)	Model	Watts Δt 50°C	Btu's Δt 50°C	White Ex VAT	White Inc VAT	RALs & Special Finishes Ex VAT	RALs & Special Finishes Inc VAT
DELIVERY TIMES			UP TO 5 WEEKS		UP TO 5 WEEKS			
500	520	SAXSV505213	355	1211	£515.00	£618.00	£643.75	£772.50
	600	SAXSV506015	409	1396	£541.00	£649.20	£676.25	£811.50
	800	SAXSV508020	546	1863	£600.00	£720.00	£750.00	£900.00
	1000	SAXSV501025	682	2327	£690.00	£828.00	£862.50	£1,035.00
	1200	SAXSV501230	819	2794	£750.00	£900.00	£937.50	£1,125.00
630	520	SAXSV635213	431	1471	£544.00	£652.80	£680.00	£816.00
	600	SAXSV636015	498	1699	£578.00	£693.60	£722.50	£867.00
	800	SAXSV638020	664	2266	£644.00	£772.80	£805.00	£966.00
	1000	SAXSV631025	830	2832	£742.00	£890.40	£927.50	£1,113.00
1200	280	SAXSV122807	411	1402	£503.00	£603.60	£628.75	£754.50
	400	SAXSV124010	588	2006	£545.00	£654.00	£681.25	£817.50
	520	SAXSV125213	764	2607	£630.00	£756.00	£787.50	£945.00
	600	SAXSV126015	882	3009	£671.00	£805.20	£838.75	£1,006.50

Height (mm)	Width (mm)	Model	Watts Δt 50°C	Btu's Δt 50°C	White Ex VAT	White Inc VAT	RALs & Special Finishes Ex VAT	RALs & Special Finishes Inc VAT
DELIVERY TIMES			UP TO 5 WEEKS		UP TO 5 WEEKS			
1500	280	SAXSV152807	506	1726	£525.00	£630.00	£656.25	£787.50
	400	SAXSV154010	723	2467	£572.00	£686.40	£715.00	£858.00
	520	SAXSV155213	940	3207	£663.00	£795.60	£828.75	£994.50
	600	SAXSV156015	1085	3702	£709.00	£850.80	£886.25	£1,063.50
1800	280	SAXSV182807	603	2057	£541.00	£649.20	£676.25	£811.50
	600	SAXSV186015	1292	4408	£743.00	£891.60	£928.75	£1,114.50
2000	280	SAXSV202807	669	2283	£553.00	£663.60	£691.25	£829.50
	400	SAXSV204010	955	3258	£603.00	£723.60	£753.75	£904.50
	520	SAXSV205213	1242	4238	£709.00	£850.80	£886.25	£1,063.50
	600	SAXSV206015	1433	4889	£762.00	£914.40	£952.50	£1,143.00

Stock options White RAL 9016 - Double Vertical

Please add 10% to the RAL/Special Finish price to work out your Feature Finish price

Height (mm)	Width (mm)	Model	Watts Δt 50°C	Btu's Δt 50°C	White Ex VAT	White Inc VAT	RALs & Special Finishes Ex VAT	RALs & Special Finishes Inc VAT
DELIVERY TIMES			48-72 HOURS		UP TO 5 WEEKS			
1800	400	SAXDV184010	1356	4627	£1,131.00	£1,357.20	£1,413.75	£1,696.50
	520	SAXDV185213	1762	6012	£1,310.00	£1,572.00	£1,637.50	£1,965.00

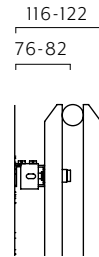

Pipe centres left to right	Pipe centres from wall	Depth from wall
width + valves	76mm to 82mm	116mm to 122mm

Made to order options - Double Vertical

Height (mm)	Width (mm)	Model	Watts Δt 50°C	Btu's Δt 50°C	White Ex VAT	White Inc VAT	RALs & Special Finishes Ex VAT	RALs & Special Finishes Inc VAT
DELIVERY TIMES			UP TO 5 WEEKS		UP TO 5 WEEKS			
500	520	SAXDV505213	566	1931	£1,019.00	£1,222.80	£1,273.75	£1,528.50
	600	SAXDV506015	654	2231	£1,079.00	£1,294.80	£1,348.75	£1,618.50
	800	SAXDV508020	872	2975	£1,193.00	£1,431.60	£1,491.25	£1,789.50
	1000	SAXDV501025	1090	3719	£1,372.00	£1,646.40	£1,715.00	£2,058.00
	1200	SAXDV501230	1308	4463	£1,493.00	£1,791.60	£1,866.25	£2,239.50
630	520	SAXDV635213	698	2382	£1,052.00	£1,262.40	£1,315.00	£1,578.00
	600	SAXDV636015	805	2747	£1,114.00	£1,336.80	£1,392.50	£1,671.00
	800	SAXDV638020	1074	3664	£1,239.00	£1,486.80	£1,548.75	£1,858.50
	1000	SAXDV631025	1342	4579	£1,427.00	£1,712.40	£1,783.75	£2,140.50
1200	280	SAXDV122807	668	2279	£938.00	£1,125.60	£1,172.50	£1,407.00
	400	SAXDV124010	954	3255	£1,014.00	£1,216.80	£1,267.50	£1,521.00
	520	SAXDV125213	1240	4231	£1,170.00	£1,404.00	£1,462.50	£1,755.00
	600	SAXDV126015	1431	4883	£1,250.00	£1,500.00	£1,562.50	£1,875.00

Height (mm)	Width (mm)	Model	Watts Δt 50°C	Btu's Δt 50°C	White Ex VAT	White Inc VAT	RALs & Special Finishes Ex VAT	RALs & Special Finishes Inc VAT
DELIVERY TIMES			UP TO 5 WEEKS		UP TO 5 WEEKS			
1500	280	SAXDV152807	811	2767	£968.00	£1,161.60	£1,210.00	£1,452.00
	400	SAXDV154010	1159	3955	£1,056.00	£1,267.20	£1,320.00	£1,584.00
	520	SAXDV155213	1507	5142	£1,224.00	£1,468.80	£1,530.00	£1,836.00
	600	SAXDV156015	1738	5930	£1,310.00	£1,572.00	£1,637.50	£1,965.00
1800	280	SAXDV182807	949	3238	£1,038.00	£1,245.60	£1,297.50	£1,557.00
	600	SAXDV186015	2033	6937	£1,401.00	£1,681.20	£1,751.25	£2,101.50
2000	280	SAXDV202807	1038	3542	£1,109.00	£1,330.80	£1,386.25	£1,663.50
	400	SAXDV204010	1483	5060	£1,205.00	£1,446.00	£1,506.25	£1,807.50
	520	SAXDV205213	1927	6575	£1,397.00	£1,676.40	£1,746.25	£2,095.50
	600	SAXDV206015	2224	7588	£1,497.00	£1,796.40	£1,871.25	£2,245.50

Athena shown on pages 50-51



Steel; Slimline radiator
CE/UKCA approved & certified to BS EN442.

White RAL 9016 as standard, 188 RAL colours
31 Special Finishes (stock sizes only).

Please call **01342 302250** for a RAL or Special Finish chart.

6 NEW Feature Finishes (stock sizes only), see page 7 or call **01342 302250** for samples.



Stock White RAL 9016: 48-72 Hours

Special & Feature Finishes: Up to 2 weeks

Made to Order White and RAL Colours: Up to 6 weeks.

Pipe centres left to right	Pipe centres from wall	Depth from wall
width - 70mm	45mm to 53mm	67mm to 75mm

Ideal TRV & Pipe Covers



SAVE £45*

WHEN YOU BUY OUR IDEAL TRV & PIPE COVERS WITH ANY DESIGNER PURCHASE. QUOTE **PROMOVI** AT TIME OF ORDER.

Available in White or Chrome.

Stock options White RAL 9016 - Horizontal

Please add 10% to the RAL price to work out your Special or Feature Finish price

Height (mm)	Width (mm)	Model	Watts Δt 50°C	Btu's Δt 50°C	White Ex VAT	White Inc VAT	RAL Colours Ex VAT	RAL Colours Inc VAT
DELIVERY TIMES					48-72 HOURS		UP TO 6 WEEKS	
410	1000	ATHEH4110	392	1338	£657.00	£788.40	£821.25	£985.50
	1200	ATHEH4112	474	1617	£697.00	£836.40	£871.25	£1,045.50
495	1000	ATHEH4910	460	1570	£692.00	£830.40	£865.00	£1,038.00
	1200	ATHEH4912	553	1887	£735.00	£882.00	£918.75	£1,102.50

Special and Feature Finishes delivered in up to 2 weeks

Feature Finishes (for stock sizes)

See page 7 for more details or call customer services for sample swatches.

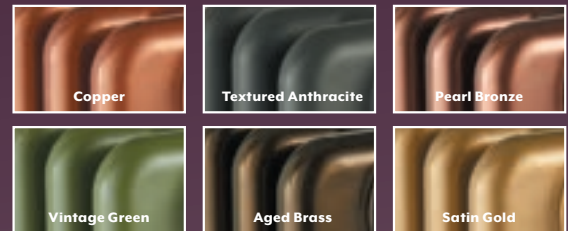

To work out your Special or Feature Finish price please add 10% to the RAL Colour price shown in the pricing tables left.

Made to order options White & RAL Colours - Horizontal

Height (mm)	Width (mm)	Model	Watts Δt 50°C	Btu's Δt 50°C	White Ex VAT	White Inc VAT	RAL Colours Ex VAT	RAL Colours Inc VAT
DELIVERY TIMES					UP TO 6 WEEKS		UP TO 6 WEEKS	
410	1500	ATHEH4115	570	1945	£754.00	£904.80	£942.50	£1,131.00
495	1500	ATHEH4915	694	2368	£799.00	£958.80	£998.75	£1,198.50

67-75
45-53

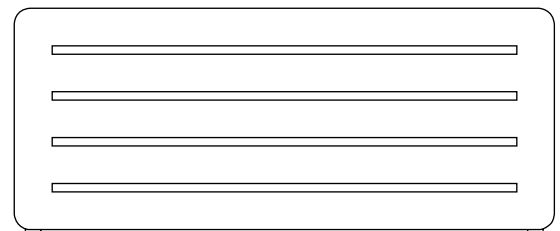

Stock options White RAL 9016 - Vertical

Please add 10% to the RAL price to work out your Special or Feature Finish price

Height (mm)	Width (mm)	Model	Watts Δt 50°C	Btu's Δt 50°C	White Ex VAT	White Inc VAT	RAL Colours Ex VAT	RAL Colours Inc VAT
DELIVERY TIMES					48-72 HOURS		UP TO 6 WEEKS	
1800	410	ATHEV1841	686	2341	£722.00	£866.40	£902.50	£1,083.00
	495	ATHEV1849	837	2856	£753.00	£903.60	£941.25	£1,129.50

Special and Feature Finishes delivered in up to 2 weeks

Made to order options White & RAL Colours - Vertical

Height (mm)	Width (mm)	Model	Watts Δt 50°C	Btu's Δt 50°C	White Ex VAT	White Inc VAT	RAL Colours Ex VAT	RAL Colours Inc VAT
DELIVERY TIMES					UP TO 6 WEEKS		UP TO 6 WEEKS	
1500	410	ATHEV1541	575	1962	£693.00	£831.60	£866.25	£1,039.50
	495	ATHEV1549	697	2378	£726.00	£871.20	£907.50	£1,089.00

67-75
45-53

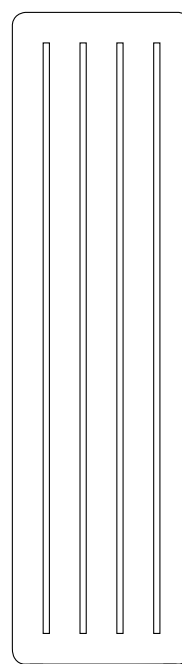

*Saving based on the value of individual items when bought separately. Order any of our selected valves & matching pipe covers at the same time as your radiator; PROMOVIW (white), PROMOVIC (chrome).

Halo shown on page 60-61

High quality Italian design & manufacture.
Steel; 87mm, 133mm, 155mm 180mm & 187mm fins
CE/UKCA approved & certified to BS EN442.

Matt White RAL 9016 as standard, 188 RAL colours
2 Special Finishes; Metallic Silver & Matt Black
Please call **01342 302250** for a RAL chart.

Made to Order sizes & colours: Up to 7 weeks



Ideal TRV & Pipe Covers

SAVE £45*
WHEN YOU BUY OUR IDEAL TRV & PIPE COVERS WITH ANY DESIGNER PURCHASE.
QUOTE PROMOV1 AT TIME OF ORDER.

Available in White or Chrome.

Made to order options - Horizontal White & Colours

Height (mm)	Width (mm)	Model	Watts Δt 50°C	BTU's Δt 50°C	Matt White Ex VAT	Matt White Inc VAT	Colour & Finishes Ex VAT	Colour & Finishes Inc VAT
DELIVERY TIMES					UP TO 7 WEEKS		UP TO 7 WEEKS	
130	1000	HALO1310	269	918	£949.00	£1,138.80	£1,138.80	£1,366.56
	1500	HALO1315	413	1409	£1,029.00	£1,234.80	£1,234.80	£1,481.76
	2000	HALO1320	557	1900	£1,107.00	£1,328.40	£1,328.40	£1,594.08
190	1000	HALO1910	401	1368	£1,156.00	£1,387.20	£1,387.20	£1,664.64
	1500	HALO1915	616	2102	£1,264.00	£1,516.80	£1,516.80	£1,820.16
	2000	HALO1920	831	2835	£1,399.00	£1,678.80	£1,678.80	£2,014.56
250	1000	HALO2510	993	3388	£1,177.00	£1,412.40	£1,412.40	£1,694.88
	1500	HALO2515	1490	5084	£1,492.00	£1,790.40	£1,790.40	£2,148.48
	2000	HALO2520	1969	6718	£1,949.00	£2,338.80	£2,338.80	£2,806.56

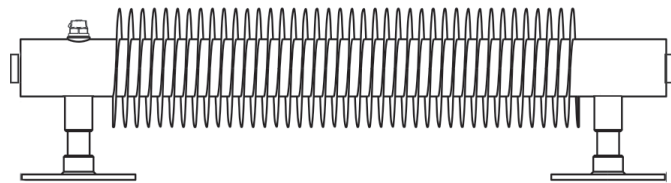

Made to order options - Horizontal Electric

Height (mm)	Width (mm)	Model	Watts Δt 50°C	Matt White Ex VAT	Matt White Inc VAT	Colour & Finishes Ex VAT	Colour & Finishes Inc VAT
DELIVERY TIMES				UP TO 7 WEEKS		UP TO 7 WEEKS	
180	1015	HALOE1810	500	£1,397.00	£1,676.40	£1,676.40	£2,011.68
	1515	HALOE1815	750	£1,600.00	£1,920.00	£1,920.00	£2,304.00
	2015	HALOE1820	1000	£1,772.00	£2,126.40	£2,126.40	£2,551.68

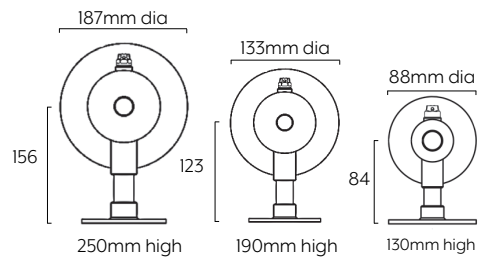

Halo Horizontal	Pipe centres left to right	Pipe centres from wall
Halo 130mm	width + valves	minimum of 65mm
Halo 190mm	width + valves	minimum of 90mm
Halo 250mm	width + valves	minimum of 120mm

Made to order options - Vertical White & Colours

Height (mm)	Width (mm)	Model	Watts Δt 50°C	BTU's Δt 50°C	Matt White Ex VAT	Matt White Inc VAT	Colour & Finishes Ex VAT	Colour & Finishes Inc VAT
DELIVERY TIMES					UP TO 7 WEEKS		UP TO 7 WEEKS	
1500	155	HALOV1515	865	2951	£1,646.00	£1,975.20	£1,975.20	£2,370.24
1800	155	HALOV1815	1040	3548	£1,799.00	£2,158.80	£2,158.80	£2,590.56
2000	155	HALOV2015	1153	3934	£1,863.00	£2,235.60	£2,235.60	£2,682.72

Halo Vertical	Pipe centres left to right	Pipe centres from wall	Depth from wall
Halo 155mm	60mm	148mm	225mm

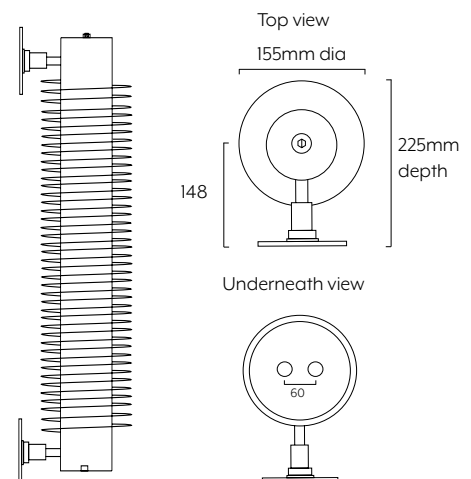

*Saving based on the value of individual items when bought separately.
Order any of our selected valves & matching pipe covers at the same time as your radiator; PROMOV1W (white), PROMOV1C (chrome).

Sectional Stocked Aluminium

All our sectional aluminium is held in stock in the UK. White product can be delivered in 48-72 hours and coloured orders will be finished and delivered in up to 2 weeks. Our most popular sizes are listed in the price tables, for other sizes use our online radiator builder or follow the instructions below to specify your radiator.

Choose your radiator using our online radiator builder

Once you know your outputs use our **online radiator builder** to select the best solution for your room. It will take you through the process quickly and easily and allows you to save your ideas to your own Wish List. Go to our website **theradiatorcompany.co.uk**

It is vital to know the correct heat output you need to keep your room warm. Use our online Heat Output Calculator to get a guide to your requirements which you can then check with your installer.



Once you know your outputs you can also use the brochure to specify your radiator by following these steps (or call our Customer Services team on 01342 302250 who will help you size your radiator)

Note the space you have in mind for the radiator(s) you need; vertical or horizontal, length, height & depth

- Select a column option and height that fits your space; Calculate the number of Sections you need by dividing the required BTU (Watt) output with the output per section; e.g $4811 \text{ BTUs divided by } 420 = 11.45$, (we always suggest rounding up, as it is better to have too much output, than too little) therefore 12 sections based on Vip 590
- If using that section size does work in the space available, try a different height or alternative aluminium profile
- Once you have calculated the best number and size of section, select your colour. Our Aluminium Radiators are available in a selection of the top 23 most popular colours from the RAL range and 31 Special Finishes (shown on pages 63 & 216). Please specify your RAL colour, special or feature finish at time of order. White RAL 9010 is our standard for the Vip, Oscar, Vox and Mix
- Work out the price of your radiator by multiplying the section price by the total number of sections e.g *Vip 590 high, 12 sections in RAL 3000 - Flame Red* = $£76.72 \times 12 = £920.64$ (inc VAT)
- Place your order by using the Sectional Model Code x No. of Sections needed and noting the colour number and name selected; e.g *VIP59 X 12 in RAL 3000*
- If you have chosen a colour make sure you list the colour number and name

All prices and outputs are given per section in the tables on pages 176-183. Price per section includes plugs, bushes and diverter.

End Panels for the Vip & Oscar must be specified at time of order, please see page 175 for more information.

Aluminium Colours

All our Sectional Aluminium radiators are available in a selection of the top 23 most popular colours from the RAL range as well as 31 exclusive special finishes and 6 feature finishes. These radiators provide both the efficiencies of aluminium and a stunning finish. Available in up to 2 weeks. Please call **01342 302250** for a RAL or Special Finish chart.

31 Special Finishes

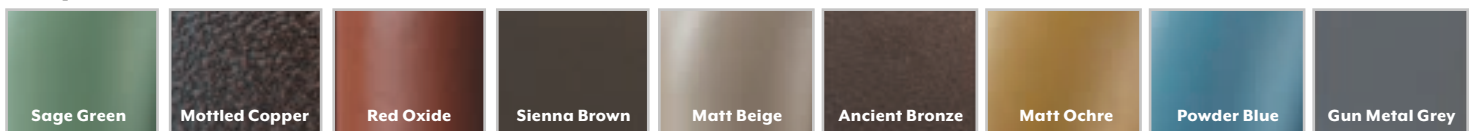

Feature Finishes

Painted in the UK, our Feature Finishes give a personal touch to any room, choose from Vintage Green, Satin Gold, Aged Brass, Textured Anthracite, Copper and Pearl Bronze. See page 7 for more details or call customer services for sample swatches.



Colour Coordination Service

Available for all sectional aluminium, see product pages 217 for full details including process & lead times.

Aluminium Accessories

Hanging Bars & Pegs

These towel bars and pegs are designed to fit all of our sectional aluminium ranges. Ideal for providing additional hanging space to air towels or hang bathrobes. **Available from stock in 48-72 hours.**

Description/ Suitable for	Model	White Ex VAT	White Inc VAT	Chrome Ex VAT	Chrome Inc VAT
DELIVERY TIMES		48-72 HOURS			
Peg / Vip, Mix, Vox, Oscar	AAHPEG01	£29.00	£34.80	£35.00	£42.00
Bar 480mm / Vip, Mix, Vox, Oscar	AAHBAR01	£84.00	£100.80	£103.00	£123.60
Bar 320mm / Vip, Mix, Vox, Oscar	AAHBAR02	£84.00	£100.80	£103.00	£123.60

320mm Towel Bars need a minimum of 6 sections to fit

480mm Towel Bars need a minimum of 8 sections to fit

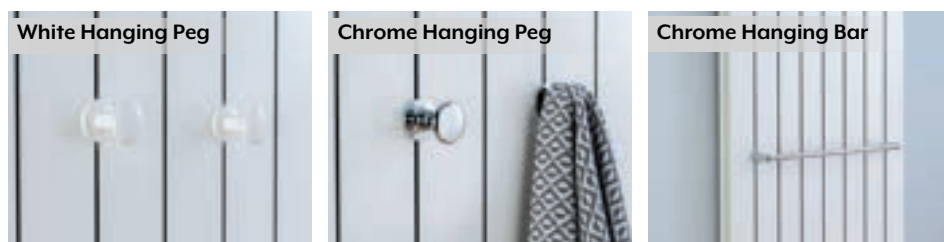

A nominal £5 charge for postage and packing will be applied to any orders under £50 in value

White Hanging Bar



Complete the look with End Panels

Vip End Panels stock options RAL 9010

Height (mm)	Model	White Ex VAT	White Inc VAT	RAL Colours Ex VAT	RAL Colours Inc VAT	Special & Feature Finishes Ex VAT	Special & Feature Finishes Inc VAT
DELIVERY TIMES		48-72 HOURS		UP TO 2 WEEKS		UP TO 2 WEEKS	
440	VIPEP44	£67.00	£80.40	£98.49	£118.19	£105.86	£127.03
590	VIPEP59	£76.00	£91.20	£111.72	£134.06	£120.08	£144.10
690	VIPEP69	£82.00	£98.40	£120.54	£144.65	£129.56	£155.47
790	VIPEP79	£84.00	£100.80	£123.48	£148.18	£132.72	£159.26

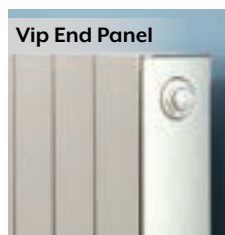

Please specify at time of order if you would like End Panels with your Vip radiator

Oscar End Panels stock options RAL 9010

Height (mm)	Model	White Ex VAT	White Inc VAT	RAL Colours Ex VAT	RAL Colours Inc VAT	Special & Feature Finishes Ex VAT	Special & Feature Finishes Inc VAT
DELIVERY TIMES		48-72 HOURS		UP TO 2 WEEKS		UP TO 2 WEEKS	
1046	OSCAEP10	£106.00	£127.20	£154.76	£185.71	£167.48	£200.98
1246	OSCAEP12	£109.00	£130.80	£159.14	£190.97	£172.22	£206.66
1446	OSCAEP14	£118.00	£141.60	£172.28	£206.74	£186.44	£223.73
1646	OSCAEP16	£136.00	£163.20	£198.56	£238.27	£214.88	£257.86
1846	OSCAEP18	£140.00	£168.00	£204.40	£245.28	£221.20	£265.44
2046	OSCAEP20	£146.00	£175.20	£213.16	£255.79	£230.68	£276.82

Please specify at time of order if you would like End Panels with your Oscar radiator

Joining Key

Joining Keys are available on a sale or return basis. Joining Keys must be specified at time of order. For assistance please contact our Customer Service team on **01342 302250**, they will also arrange a courier to collect it from you when you are ready.

Description/ Suitable for	Model	Price Ex VAT	Price Inc VAT
DELIVERY TIMES		48-72 HOURS	
Joining Key 1" x 300mm/600mm	PPASM	£557.00	£668.40





High quality Italian design & manufacture.
Sectional Aluminium. CE/UKCA approved & certified to BS EN442.



White RAL 9010 as standard, 23 RAL colours, 31 Special Finishes & 6 Feature Finishes (page 7). Please call **01342 302250** for a RAL or Special Finish chart.
Colour Coordination Service available on stock sizes **see page 217** for full details.

Stock White RAL 9010: 48-72 Hours

Colours & Special / Feature Finishes: Up to 2 weeks



SAVE £45*
WHEN YOU BUY OUR IDEAL TRV & PIPE COVERS WITH ANY DESIGNER PURCHASE. QUOTE PROMOV1 AT TIME OF ORDER.

Choose from our assembled stock options or build your own size by individual section, visit **theradiatorcompany.co.uk** to use our radiator builder.

Available in White or Chrome.

Assembled stock options RAL 9010

440mm High

Height (mm)	Width (mm)	Sections	Model	Watts Δt 50°C	Btu's Δt 50°C	White Ex VAT		RAL Colours Ex VAT	RAL Colours Inc VAT	Special & Feature Finishes	
						White Ex VAT	White Inc VAT	Ex VAT	Inc VAT	Ex VAT	Inc VAT
DELIVERY TIMES						48-72 HOURS		UP TO 2 WEEKS		UP TO 2 WEEKS	
440	420	5	VIPS44X5	470	1604	£222.70	£267.24	£314.00	£376.80	£336.30	£403.56
	500	6	VIPS44X6	564	1924	£267.24	£320.69	£376.80	£452.16	£403.56	£484.27
	580	7	VIPS44X7	658	2245	£311.78	£374.14	£439.60	£527.52	£470.82	£564.98
	660	8	VIPS44X8	752	2566	£356.32	£427.58	£502.40	£602.88	£538.08	£645.70
	740	9	VIPS44X9	846	2887	£400.86	£481.03	£565.20	£678.24	£605.34	£726.41
	820	10	VIPS44X10	940	3207	£445.40	£534.48	£628.00	£753.60	£672.60	£807.12
	900	11	VIPS44X11	1034	3528	£489.94	£587.93	£690.80	£828.96	£739.86	£887.83
	980	12	VIPS44X12	1128	3849	£534.48	£641.38	£753.60	£904.32	£807.12	£968.54
	1060	13	VIPS44X13	1222	4169	£579.02	£694.82	£816.40	£979.68	£874.38	£1,049.26
	1140	14	VIPS44X14	1316	4490	£623.56	£748.27	£879.20	£1,055.04	£941.64	£1,129.97
	1220	15	VIPS44X15	1410	4811	£668.10	£801.72	£942.00	£1,130.40	£1,008.90	£1,210.68
	1300	16	VIPS44X16	1504	5132	£712.64	£855.17	£1,004.80	£1,205.76	£1,076.16	£1,291.39
	1380	17	VIPS44X17	1598	5452	£757.18	£908.62	£1,067.60	£1,281.12	£1,143.42	£1,372.10
	1460	18	VIPS44X18	1692	5773	£801.72	£962.06	£1,130.40	£1,356.48	£1,210.68	£1,452.82
1540	19	VIPS44X19	1786	6094	£846.26	£1,015.51	£1,193.20	£1,431.84	£1,277.94	£1,533.53	
1620	20	VIPS44X20	1880	6415	£890.80	£1,068.96	£1,256.00	£1,507.20	£1,345.20	£1,614.24	

Widths include measurement for bushes

Quoted prices include plugs, bushes, air vent and wall brackets but excludes end panels.

Optional end panels available, please specify at time of order, see page 175 for prices.

Pipe centres left to right	Pipe centres from wall	Depth from wall
width + valves	67mm to 71mm	114mm to 118mm

23 RAL colours are shown on page 216

590mm High

Height (mm)	Width (mm)	Sections	Model	Watts Δt 50°C	Btu's Δt 50°C	White Ex VAT		RAL Colours Ex VAT	RAL Colours Inc VAT	Special & Feature Finishes	
						White Ex VAT	White Inc VAT	Ex VAT	Inc VAT	Ex VAT	Inc VAT
DELIVERY TIMES						48-72 HOURS		UP TO 2 WEEKS		UP TO 2 WEEKS	
590	420	5	VIPS59X5	615	2098	£226.70	£272.04	£319.65	£383.58	£342.30	£410.76
	500	6	VIPS59X6	738	2518	£272.04	£326.45	£383.58	£460.30	£410.76	£492.91
	580	7	VIPS59X7	861	2938	£317.38	£380.86	£447.51	£537.01	£479.22	£575.06
	660	8	VIPS59X8	984	3357	£362.72	£435.26	£511.44	£613.73	£547.68	£657.22
	740	9	VIPS59X9	1107	3777	£408.06	£489.67	£575.37	£690.44	£616.14	£739.37
	820	10	VIPS59X10	1230	4197	£453.40	£544.08	£639.30	£767.16	£684.60	£821.52
	900	11	VIPS59X11	1353	4616	£498.74	£598.49	£703.23	£843.88	£753.06	£903.67
	980	12	VIPS59X12	1476	5036	£544.08	£652.90	£767.16	£920.59	£821.52	£985.82
	1060	13	VIPS59X13	1599	5456	£589.42	£707.30	£831.09	£997.31	£889.98	£1,067.98
	1140	14	VIPS59X14	1722	5875	£634.76	£761.71	£895.02	£1,074.02	£958.44	£1,150.13
	1220	15	VIPS59X15	1845	6295	£680.10	£816.12	£958.95	£1,150.74	£1,026.90	£1,232.28
	1300	16	VIPS59X16	1968	6715	£725.44	£870.53	£1,022.88	£1,227.46	£1,095.36	£1,314.43
	1380	17	VIPS59X17	2091	7134	£770.78	£924.94	£1,086.81	£1,304.17	£1,163.82	£1,396.58
	1460	18	VIPS59X18	2214	7554	£816.12	£979.34	£1,150.74	£1,380.89	£1,232.28	£1,478.74
1540	19	VIPS59X19	2337	7974	£861.46	£1,033.75	£1,214.67	£1,457.60	£1,300.74	£1,560.89	
1620	20	VIPS59X20	2460	8394	£906.80	£1,088.16	£1,278.60	£1,534.32	£1,369.20	£1,643.04	

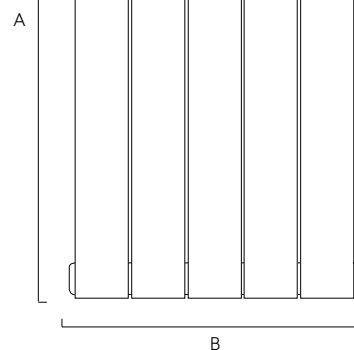

Optional end panels available for the Vip range, see page 175 for more information and pricing.

Please specify at time of order.

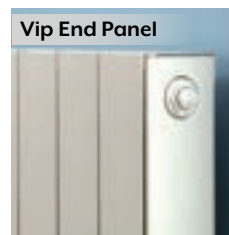

23 RAL colours are shown on page 216

*Saving based on the value of individual items when bought separately. Order any of our selected valves & matching pipe covers at the same time as your radiator; PROMOV1W (white), PROMOV1C (chrome).

Assembled stock option RAL 9010

690mm High

Height (mm)	Width (mm)	Sections	Model	Watts Δt 50°C	Btu's Δt 50°C	White Ex VAT	White Inc VAT	RAL Colours		Special & Feature Finishes	
								Ex VAT	Inc VAT	Ex VAT	Inc VAT
DELIVERY TIMES						48-72 HOURS		UP TO 2 WEEKS		UP TO 2 WEEKS	
690	420	5	VIPS69X5	710	2423	£234.90	£281.88	£331.20	£397.44	£354.70	£425.64
	500	6	VIPS69X6	852	2907	£281.88	£338.26	£397.44	£476.93	£425.64	£510.77
	580	7	VIPS69X7	994	3392	£328.86	£394.63	£463.68	£556.42	£496.58	£595.90
	660	8	VIPS69X8	1136	3876	£375.84	£451.01	£529.92	£635.90	£567.52	£681.02
	740	9	VIPS69X9	1278	4361	£422.82	£507.38	£596.16	£715.39	£638.46	£766.15
	820	10	VIPS69X10	1420	4845	£469.80	£563.76	£662.40	£794.88	£709.40	£851.28
	900	11	VIPS69X11	1562	5330	£516.78	£620.14	£728.64	£874.37	£780.34	£936.41
	980	12	VIPS69X12	1704	5814	£563.76	£676.51	£794.88	£953.86	£851.28	£1,021.54
	1060	13	VIPS69X13	1846	6299	£610.74	£732.89	£861.12	£1,033.34	£922.22	£1,106.66
	1140	14	VIPS69X14	1988	6783	£657.72	£789.26	£927.36	£1,112.83	£993.16	£1,191.79
	1220	15	VIPS69X15	2130	7268	£704.70	£845.64	£993.60	£1,192.32	£1,064.10	£1,276.92
	1300	16	VIPS69X16	2272	7752	£751.68	£902.02	£1,059.84	£1,271.81	£1,135.04	£1,362.05
	1380	17	VIPS69X17	2414	8237	£798.66	£958.39	£1,126.08	£1,351.30	£1,205.98	£1,447.18
	1460	18	VIPS69X18	2556	8721	£845.64	£1,014.77	£1,192.32	£1,430.78	£1,276.92	£1,532.30
	1540	19	VIPS69X19	2698	9206	£892.62	£1,071.14	£1,258.56	£1,510.27	£1,347.86	£1,617.43
	1620	20	VIPS69X20	2840	9690	£939.60	£1,127.52	£1,324.80	£1,589.76	£1,418.80	£1,702.56

23 RAL colours are shown on page 216

790mm High

Height (mm)	Width (mm)	Sections	Model	Watts Δt 50°C	Btu's Δt 50°C	White Ex VAT	White Inc VAT	RAL Colours		Special & Feature Finishes	
								Ex VAT	Inc VAT	Ex VAT	Inc VAT
DELIVERY TIMES						48-72 HOURS		UP TO 2 WEEKS		UP TO 2 WEEKS	
790	420	5	VIPS79X5	805	2747	£266.95	£320.34	£376.40	£451.68	£403.10	£483.72
	500	6	VIPS79X6	966	3296	£320.34	£384.41	£451.68	£542.02	£483.72	£580.46
	580	7	VIPS79X7	1127	3845	£373.73	£448.48	£526.96	£632.35	£564.34	£677.21
	660	8	VIPS79X8	1288	4395	£427.12	£512.54	£602.24	£722.69	£644.96	£773.95
	740	9	VIPS79X9	1449	4944	£480.51	£576.61	£677.52	£813.02	£725.58	£870.70
	820	10	VIPS79X10	1610	5493	£533.90	£640.68	£752.80	£903.36	£806.20	£967.44
	900	11	VIPS79X11	1771	6043	£587.29	£704.75	£828.08	£993.70	£886.82	£1,064.18
	980	12	VIPS79X12	1932	6592	£640.68	£768.82	£903.36	£1,084.03	£967.44	£1,160.93
	1060	13	VIPS79X13	2093	7141	£694.07	£832.88	£978.64	£1,174.37	£1,048.06	£1,257.67
	1140	14	VIPS79X14	2254	7691	£747.46	£896.95	£1,053.92	£1,264.70	£1,128.68	£1,354.42
	1220	15	VIPS79X15	2415	8240	£800.85	£961.02	£1,129.20	£1,355.04	£1,209.30	£1,451.16
	1300	16	VIPS79X16	2576	8789	£854.24	£1,025.09	£1,204.48	£1,445.38	£1,289.92	£1,547.90
	1380	17	VIPS79X17	2737	9339	£907.63	£1,089.16	£1,279.76	£1,535.71	£1,370.54	£1,644.65
	1460	18	VIPS79X18	2898	9888	£961.02	£1,153.22	£1,355.04	£1,626.05	£1,451.16	£1,741.39
	1540	19	VIPS79X19	3059	10437	£1,014.41	£1,217.29	£1,430.32	£1,716.38	£1,531.78	£1,838.14
	1620	20	VIPS79X20	3220	10987	£1,067.80	£1,281.36	£1,505.60	£1,806.72	£1,612.40	£1,934.88

23 RAL colours are shown on page 216

Stock options by section RAL 9010

Outputs & price given per section, see page 174 for help on sizing your radiator or visit theradiatorcompany.co.uk where you will find our radiator builder.

Height (mm)	Width (mm)	Model	Watts Δt 50°C	Btu's Δt 50°C	White Ex VAT	White Inc VAT	RAL Colours		Special & Feature Finishes		
							Ex VAT	Inc VAT	Ex VAT	Inc VAT	
DELIVERY TIMES						48-72 HOURS		UP TO 2 WEEKS			
440	80	VIP44	94	321	£44.54	£53.45	£62.80	£75.36	£67.26	£80.71	
590		VIP59	123	420	£45.34	£54.41	£63.93	£76.72	£68.46	£82.15	
690		VIP69	142	485	£46.98	£56.38	£66.24	£79.49	£70.94	£85.13	
790		VIP79	161	549	£53.39	£64.07	£75.28	£90.34	£80.62	£96.74	

23 RAL colours are shown on page 216

Pipe centres left to right	Pipe centres from wall	Depth from wall
no. of sections x 80mm + 20mm bushes + valves	67mm-71mm	114mm-118mm

Note: Supplied pre-assembled in up to 20 sections (1600mm), wider radiators must be joined on site.

Widths include measurement for bushes

Quoted prices include plugs, bushes, air vent and wall brackets but excludes end panels.

Optional end panels available, please specify at time of order, see page 175 for prices.

Pipe centres left to right	Pipe centres from wall	Depth from wall
width + valves	67mm-71mm	114mm-118mm

VIP69X5 - 690mm x 420mm

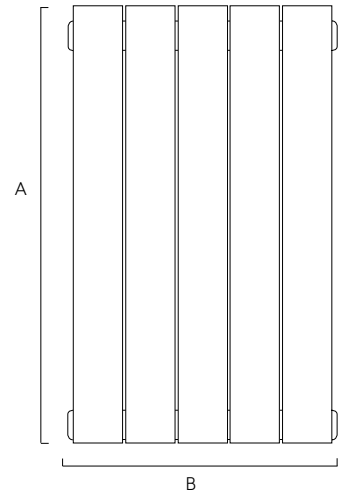

Feature Finishes

See page 7 for more details or call customer services for sample swatches.



Optional end panels available for the Vip range, see page 175 for more information and pricing

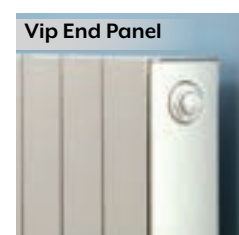



High quality Italian design & manufacture.
Sectional Aluminium. CE/UKCA approved & certified to BS EN442.



White RAL 9010 as standard, 23 RAL colours, 31 Special Finishes & 6 Feature Finishes. Please call **01342 302250** for a RAL or Special Finish chart.
Colour Coordination Service available on stock sizes **see page 217** for full details

Stock White RAL 9010: 48-72 Hours

Colours & Special / Feature Finishes: Up to 2 weeks.



Choose from our assembled stock options or build your own size by individual section, visit theradiatorcompany.co.uk to use our radiator builder.

Ideal TRV & Pipe Covers



SAVE £45*

WHEN YOU BUY OUR IDEAL TRV & PIPE COVERS WITH ANY DESIGNER PURCHASE. QUOTE **PROMOVI** AT TIME OF ORDER.

Available in White or Chrome.

Assembled stock options RAL 9010

1046mm High

Height (mm)	Width (mm)	Sections	Model	Watts Δt 50°C	Btu's Δt 50°C	White Ex VAT	White Inc VAT	RAL Colours	RAL Colours	Special & Feature Finishes	
								Ex VAT	Inc VAT	Ex VAT	Inc VAT
DELIVERY TIMES						48-72 HOURS		UP TO 2 WEEKS		UP TO 2 WEEKS	
1046	260	3	OSCASI0X3	570	1945	£227.40	£272.88	£320.64	£384.77	£343.38	£412.06
	340	4	OSCASI0X4	760	2593	£303.20	£363.84	£427.52	£513.02	£457.84	£549.41
	420	5	OSCASI0X5	950	3241	£379.00	£454.80	£534.40	£641.28	£572.30	£686.76
	500	6	OSCASI0X6	1140	3890	£454.80	£545.76	£641.28	£769.54	£686.76	£824.11
	580	7	OSCASI0X7	1330	4538	£530.60	£636.72	£748.16	£897.79	£801.22	£961.46
	660	8	OSCASI0X8	1520	5186	£606.40	£727.68	£855.04	£1,026.05	£915.68	£1,098.82
	740	9	OSCASI0X9	1710	5835	£682.20	£818.64	£961.92	£1,154.30	£1,030.14	£1,236.17
	820	10	OSCASI0X10	1900	6483	£758.00	£909.60	£1,068.80	£1,282.56	£1,144.60	£1,373.52

23 RAL colours are shown on page 216

1246mm High

Height (mm)	Width (mm)	Sections	Model	Watts Δt 50°C	Btu's Δt 50°C	White Ex VAT	White Inc VAT	RAL Colours	RAL Colours	Special & Feature Finishes	
								Ex VAT	Inc VAT	Ex VAT	Inc VAT
DELIVERY TIMES						48-72 HOURS		UP TO 2 WEEKS		UP TO 2 WEEKS	
1246	260	3	OSCASI2X3	654	2231	£296.13	£355.36	£417.54	£501.05	£447.15	£536.58
	340	4	OSCASI2X4	872	2975	£394.84	£473.81	£556.72	£668.06	£596.20	£715.44
	420	5	OSCASI2X5	1090	3719	£493.55	£592.26	£695.90	£835.08	£745.25	£894.30
	500	6	OSCASI2X6	1308	4463	£592.26	£710.71	£835.08	£1,002.10	£894.30	£1,073.16
	580	7	OSCASI2X7	1526	5207	£690.97	£829.16	£974.26	£1,169.11	£1,043.35	£1,252.02
	660	8	OSCASI2X8	1744	5951	£789.68	£947.62	£1,113.44	£1,336.13	£1,192.40	£1,430.88
	740	9	OSCASI2X9	1962	6694	£888.39	£1,066.07	£1,252.62	£1,503.14	£1,341.45	£1,609.74
	820	10	OSCASI2X10	2180	7438	£987.10	£1,184.52	£1,391.80	£1,670.16	£1,490.50	£1,788.60

23 RAL colours are shown on page 216

1446mm High

Height (mm)	Width (mm)	Sections	Model	Watts Δt 50°C	Btu's Δt 50°C	White Ex VAT	White Inc VAT	RAL Colours	RAL Colours	Special & Feature Finishes	
								Ex VAT	Inc VAT	Ex VAT	Inc VAT
DELIVERY TIMES						48-72 HOURS		UP TO 2 WEEKS		UP TO 2 WEEKS	
1446	260	3	OSCASI4X3	735	2508	£365.82	£438.98	£515.82	£618.98	£552.39	£662.87
	340	4	OSCASI4X4	980	3344	£487.76	£585.31	£687.76	£825.31	£736.52	£883.82
	420	5	OSCASI4X5	1225	4180	£609.70	£731.64	£859.70	£1,031.64	£920.65	£1,104.78
	500	6	OSCASI4X6	1470	5016	£731.64	£877.97	£1,031.64	£1,237.97	£1,104.78	£1,325.74
	580	7	OSCASI4X7	1715	5852	£853.58	£1,024.30	£1,203.58	£1,444.30	£1,288.91	£1,546.69
	660	8	OSCASI4X8	1960	6688	£975.52	£1,170.62	£1,375.52	£1,650.62	£1,473.04	£1,767.65
	740	9	OSCASI4X9	2205	7523	£1,097.46	£1,316.95	£1,547.46	£1,856.95	£1,657.17	£1,988.60
	820	10	OSCASI4X10	2450	8359	£1,219.40	£1,463.28	£1,719.40	£2,063.28	£1,841.30	£2,209.56

23 RAL colours are shown on page 216

Widths include measurement for bushes

Quoted prices include plugs, bushes, air vent and wall brackets but excludes end panels.

Optional end panels available, please specify at time of order, see page 175 for prices.

OSCA10X6 - 1046mm x 500mm

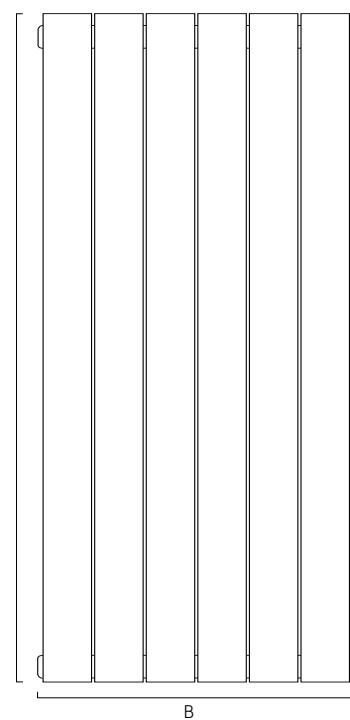

Pipe centres left to right	Pipe centres from wall	Depth from wall
width + valves	67mm to 71mm	114mm to 118mm

Optional end panels available for Oscar range, see page 175 for more information and pricing.

Oscar End Panel



Please specify at time of order

*Saving based on the value of individual items when bought separately. Order any of our selected valves & matching pipe covers at the same time as your radiator; PROMOVIW (white), PROMOVIC (chrome).

Assembled stock options RAL 9010

1646mm High

Height (mm)	Width (mm)	Sections	Model	Watts Δt 50°C	Btu's Δt 50°C	White Ex VAT	White Inc VAT	RAL Colours Ex VAT	RAL Colours Inc VAT	Special & Feature Finishes Ex VAT	Special & Feature Finishes Inc VAT
DELIVERY TIMES						48-72 HOURS		UP TO 2 WEEKS		UP TO 2 WEEKS	
1646	260	3	OSCASI6X3	813	2774	£403.65	£484.38	£569.16	£682.99	£609.51	£731.41
	340	4	OSCASI6X4	1084	3699	£538.20	£645.84	£758.88	£910.66	£812.68	£975.22
	420	5	OSCASI6X5	1355	4623	£672.75	£807.30	£948.60	£1,138.32	£1,015.85	£1,219.02
	500	6	OSCASI6X6	1626	5548	£807.30	£968.76	£1,138.32	£1,365.98	£1,219.02	£1,462.82
	580	7	OSCASI6X7	1897	6473	£941.85	£1,130.22	£1,328.04	£1,593.65	£1,422.19	£1,706.63
	660	8	OSCASI6X8	2168	7397	£1,076.40	£1,291.68	£1,517.76	£1,821.31	£1,625.36	£1,950.45
	740	9	OSCASI6X9	2439	8322	£1,210.95	£1,453.14	£1,707.48	£2,048.98	£1,828.53	£2,194.24
	820	10	OSCASI6X10	2710	9247	£1,345.50	£1,614.60	£1,897.20	£2,276.64	£2,031.70	£2,438.04

23 RAL colours are shown on page 216

1846mm High

Height (mm)	Width (mm)	Sections	Model	Watts Δt 50°C	Btu's Δt 50°C	White Ex VAT	White Inc VAT	RAL Colours Ex VAT	RAL Colours Inc VAT	Special & Feature Finishes Ex VAT	Special & Feature Finishes Inc VAT
DELIVERY TIMES						48-72 HOURS		UP TO 2 WEEKS		UP TO 2 WEEKS	
1846	260	3	OSCASI8X3	891	3040	£442.92	£531.50	£624.51	£749.41	£668.82	£802.58
	340	4	OSCASI8X4	1188	4053	£590.56	£708.67	£832.68	£999.22	£891.76	£1,070.11
	420	5	OSCASI8X5	1485	5067	£738.20	£885.84	£1,040.85	£1,249.02	£1,114.70	£1,337.64
	500	6	OSCASI8X6	1782	6080	£885.84	£1,063.01	£1,249.02	£1,498.82	£1,337.64	£1,605.17
	580	7	OSCASI8X7	2079	7094	£1,033.48	£1,240.18	£1,457.19	£1,748.63	£1,560.58	£1,872.70
	660	8	OSCASI8X8	2376	8107	£1,181.12	£1,417.34	£1,665.36	£1,998.43	£1,783.52	£2,140.22
	740	9	OSCASI8X9	2673	9120	£1,328.76	£1,594.51	£1,873.53	£2,248.24	£2,006.46	£2,407.75
	820	10	OSCASI8X10	2970	10134	£1,476.40	£1,771.68	£2,081.70	£2,498.04	£2,229.40	£2,675.28

23 RAL colours are shown on page 216

2046mm High

Height (mm)	Width (mm)	Sections	Model	Watts Δt 50°C	Btu's Δt 50°C	White Ex VAT	White Inc VAT	RAL Colours Ex VAT	RAL Colours Inc VAT	Special & Feature Finishes Ex VAT	Special & Feature Finishes Inc VAT
DELIVERY TIMES						48-72 HOURS		UP TO 2 WEEKS		UP TO 2 WEEKS	
2046	260	3	OSCAS20X3	963	3286	£497.73	£597.28	£701.79	£842.15	£751.56	£901.87
	340	4	OSCAS20X4	1284	4381	£663.64	£796.37	£935.72	£1,122.86	£1,002.08	£1,202.50
	420	5	OSCAS20X5	1605	5476	£829.55	£995.46	£1,169.65	£1,403.58	£1,252.60	£1,503.12
	500	6	OSCAS20X6	1926	6572	£995.46	£1,194.55	£1,403.58	£1,684.30	£1,503.12	£1,803.74
	580	7	OSCAS20X7	2247	7667	£1,161.37	£1,393.64	£1,637.51	£1,965.01	£1,753.64	£2,104.37
	660	8	OSCAS20X8	2568	8762	£1,327.28	£1,592.74	£1,871.44	£2,245.73	£2,004.16	£2,404.99
	740	9	OSCAS20X9	2889	9857	£1,493.19	£1,791.83	£2,105.37	£2,526.44	£2,254.68	£2,705.62
	820	10	OSCAS20X10	3210	10953	£1,659.10	£1,990.92	£2,339.30	£2,807.16	£2,505.20	£3,006.24

23 RAL colours are shown on page 216

Stock options by section RAL 9010

Outputs & price given per section, see page 174 for help on sizing your radiator or visit theradiatorcompany.co.uk where you will find our radiator builder.

Height (mm)	Width (mm)	Model	Watts Δt 50°C	Btu's Δt 50°C	White Ex VAT	White Inc VAT	RAL Colours Ex VAT	RAL Colours Inc VAT	Special & Feature Finishes Ex VAT	Special & Feature Finishes Inc VAT	
DELIVERY TIMES						48-72 HOURS		UP TO 2 WEEKS		UP TO 2 WEEKS	
1046	80	OSCAI0	190	648	£75.80	£90.96	£106.88	£128.26	£114.46	£137.35	
1246		OSCAI2	218	744	£98.71	£118.45	£139.18	£167.02	£149.05	£178.86	
1446		OSCAI4	245	836	£121.94	£146.33	£171.94	£206.33	£184.13	£220.96	
1646		OSCAI6	271	925	£134.55	£161.46	£189.72	£227.66	£203.17	£243.80	
1846		OSCAI8	297	1013	£147.64	£177.17	£208.17	£249.80	£222.94	£267.53	
2046		OSCA20	321	1095	£165.91	£199.09	£233.93	£280.72	£250.52	£300.62	

23 RAL colours are shown on page 216

Note: Supplied pre-assembled in up to 10 sections (800mm), wider radiators must be joined on site.

Pipe centres left to right	Pipe centres from wall	Depth from wall
no. of sections x 80mm + 20mm bushes + valves	67mm to 71mm	114mm to 118mm

Widths include measurement for bushes

Quoted prices include plugs, bushes, air vent and wall brackets but excludes end panels.

Optional end panels available, please specify at time of order, see page 175 for prices.

Pipe centres left to right	Pipe centres from wall	Depth from wall
width + valves	67mm to 71mm	114mm to 118mm

Optional end panels available for Oscar range, see page 175 for more information and pricing



Feature Finishes

See page 7 for more details or call customer services for sample swatches.

95

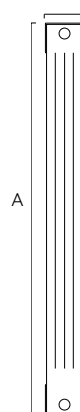

Optional end panels available for Oscar range, see page 175 for more information and pricing.

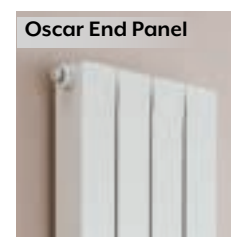

Please specify at time of order



High quality Italian design & manufacture.
Sectional Aluminium. CE/UKCA approved & certified to BS EN442.



White RAL 9010 as standard, 23 RAL colours, 31 Special Finishes & 6 Feature Finishes. Please call **01342 302250** for a RAL or Special Finish chart.
Colour Coordination Service available on stock sizes **see page 217** for full details.



Stock White RAL 9010: 48-72 Hours

Colours & Special / Feature Finishes: Up to 2 weeks.

Choose from our assembled stock options or build your own size by individual section, visit **theradiatorcompany.co.uk** to use our radiator builder.

Ideal TRV & Pipe Covers  **SAVE £45***
WHEN YOU BUY OUR IDEAL TRV & PIPE COVERS WITH ANY DESIGNER PURCHASE. QUOTE PROMOV1 AT TIME OF ORDER.

Available in White or Chrome.

Assembled stock options RAL 9010

440mm High

Height (mm)	Width (mm)	Sections	Model	Watts Δt 50°C	Btu's Δt 50°C	White		RAL Colours	RAL Colours	Special & Feature Finishes	
						Ex VAT	Inc VAT	Ex VAT	Inc VAT	Ex VAT	Inc VAT
DELIVERY TIMES						48-72 HOURS		UP TO 2 WEEKS		UP TO 2 WEEKS	
440	420	5	VOXS44X5	475	1621	£213.80	£256.56	£314.30	£377.16	£337.80	£405.36
	500	6	VOXS44X6	570	1945	£256.56	£307.87	£377.16	£452.59	£405.36	£486.43
	580	7	VOXS44X7	665	2269	£299.32	£359.18	£440.02	£528.02	£472.92	£567.50
	660	8	VOXS44X8	760	2593	£342.08	£410.50	£502.88	£603.46	£540.48	£648.58
	740	9	VOXS44X9	855	2917	£384.84	£461.81	£565.74	£678.89	£608.04	£729.65
	820	10	VOXS44X10	950	3241	£427.60	£513.12	£628.60	£754.32	£675.60	£810.72
	900	11	VOXS44X11	1045	3566	£470.36	£564.43	£691.46	£829.75	£743.16	£891.79
	980	12	VOXS44X12	1140	3890	£513.12	£615.74	£754.32	£905.18	£810.72	£972.86
	1060	13	VOXS44X13	1235	4214	£555.88	£667.06	£817.18	£980.62	£878.28	£1,053.94
	1140	14	VOXS44X14	1330	4538	£598.64	£718.37	£880.04	£1,056.05	£945.84	£1,135.01
	1220	15	VOXS44X15	1425	4862	£641.40	£769.68	£942.90	£1,131.48	£1,013.40	£1,216.08
	1300	16	VOXS44X16	1520	5186	£684.16	£820.99	£1,005.76	£1,206.91	£1,080.96	£1,297.15
	1380	17	VOXS44X17	1615	5510	£726.92	£872.30	£1,068.62	£1,282.34	£1,148.52	£1,378.22
	1460	18	VOXS44X18	1710	5835	£769.68	£923.62	£1,131.48	£1,357.78	£1,216.08	£1,459.30
	1540	19	VOXS44X19	1805	6159	£812.44	£974.93	£1,194.34	£1,433.21	£1,283.64	£1,540.37
1620	20	VOXS44X20	1900	6483	£855.20	£1,026.24	£1,257.20	£1,508.64	£1,351.20	£1,621.44	

Widths include measurement for bushes

Quoted prices include plugs, bushes, air vent and wall brackets.

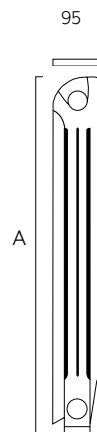

23 RAL colours are shown on page 216

590mm High

Height (mm)	Width (mm)	Sections	Model	Watts Δt 50°C	Btu's Δt 50°C	White		RAL Colours	RAL Colours	Special & Feature Finishes	
						Ex VAT	Inc VAT	Ex VAT	Inc VAT	Ex VAT	Inc VAT
DELIVERY TIMES						48-72 HOURS		UP TO 2 WEEKS		UP TO 2 WEEKS	
590	420	5	VOXS59X5	635	2167	£217.60	£261.12	£319.85	£383.82	£343.80	£412.56
	500	6	VOXS59X6	762	2600	£261.12	£313.34	£383.82	£460.58	£412.56	£495.07
	580	7	VOXS59X7	889	3033	£304.64	£365.57	£447.79	£537.35	£481.32	£577.58
	660	8	VOXS59X8	1016	3467	£348.16	£417.79	£511.76	£614.11	£550.08	£660.10
	740	9	VOXS59X9	1143	3900	£391.68	£470.02	£575.73	£690.88	£618.84	£742.61
	820	10	VOXS59X10	1270	4333	£435.20	£522.24	£639.70	£767.64	£687.60	£825.12
	900	11	VOXS59X11	1397	4767	£478.72	£574.46	£703.67	£844.40	£756.36	£907.63
	980	12	VOXS59X12	1524	5200	£522.24	£626.69	£767.64	£921.17	£825.12	£990.14
	1060	13	VOXS59X13	1651	5633	£565.76	£678.91	£831.61	£997.93	£893.88	£1,072.66
	1140	14	VOXS59X14	1778	6067	£609.28	£731.14	£895.58	£1,074.70	£962.64	£1,155.17
	1220	15	VOXS59X15	1905	6500	£652.80	£783.36	£959.55	£1,151.46	£1,031.40	£1,237.68
	1300	16	VOXS59X16	2032	6933	£696.32	£835.58	£1,023.52	£1,228.22	£1,100.16	£1,320.19
	1380	17	VOXS59X17	2159	7367	£739.84	£887.81	£1,087.49	£1,304.99	£1,168.92	£1,402.70
	1460	18	VOXS59X18	2286	7800	£783.36	£940.03	£1,151.46	£1,381.75	£1,237.68	£1,485.22
	1540	19	VOXS59X19	2413	8233	£826.88	£992.26	£1,215.43	£1,458.52	£1,306.44	£1,567.73
1620	20	VOXS59X20	2540	8666	£870.40	£1,044.48	£1,279.40	£1,535.28	£1,375.20	£1,650.24	

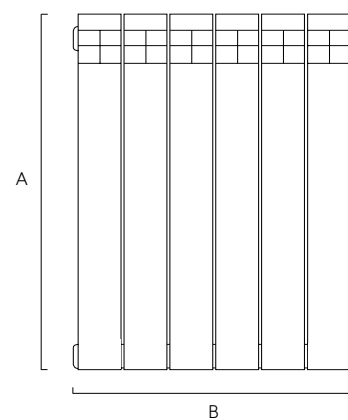

Pipe centres left to right	Pipe centres from wall	Depth from wall
width + valves	67mm to 71mm	114mm to 118mm

23 RAL colours are shown on page 216

*Saving based on the value of individual items when bought separately. Order any of our selected valves & matching pipe covers at the same time as your radiator; PROMOV1W (white), PROMOV1C (chrome).

Assembled stock options RAL 9010

690mm High

Height (mm)	Width (mm)	Sections	Model	Watts Δt 50°C	Btu's Δt 50°C	White		RAL Colours	RAL Colours	Special & Feature Finishes	
						Ex VAT	Inc VAT	Ex VAT	Inc VAT	Ex VAT	Inc VAT
DELIVERY TIMES						48-72 HOURS		UP TO 2 WEEKS		UP TO 2 WEEKS	
690	420	5	VOXS69X5	730	2491	£225.50	£270.60	£331.50	£397.80	£356.30	£427.56
	500	6	VOXS69X6	876	2989	£270.60	£324.72	£397.80	£477.36	£427.56	£513.07
	580	7	VOXS69X7	1022	3487	£315.70	£378.84	£464.10	£556.92	£498.82	£598.58
	660	8	VOXS69X8	1168	3985	£360.80	£432.96	£530.40	£636.48	£570.08	£684.10
	740	9	VOXS69X9	1314	4483	£405.90	£487.08	£596.70	£716.04	£641.34	£769.61
	820	10	VOXS69X10	1460	4982	£451.00	£541.20	£663.00	£795.60	£712.60	£855.12
	900	11	VOXS69X11	1606	5480	£496.10	£595.32	£729.30	£875.16	£783.86	£940.63
	980	12	VOXS69X12	1752	5978	£541.20	£649.44	£795.60	£954.72	£855.12	£1,026.14
	1060	13	VOXS69X13	1898	6476	£586.30	£703.56	£861.90	£1,034.28	£926.38	£1,111.66
	1140	14	VOXS69X14	2044	6974	£631.40	£757.68	£928.20	£1,113.84	£997.64	£1,197.17
	1220	15	VOXS69X15	2190	7472	£676.50	£811.80	£994.50	£1,193.40	£1,068.90	£1,282.68
	1300	16	VOXS69X16	2336	7970	£721.60	£865.92	£1,060.80	£1,272.96	£1,140.16	£1,368.19
	1380	17	VOXS69X17	2482	8469	£766.70	£920.04	£1,127.10	£1,352.52	£1,211.42	£1,453.70
	1460	18	VOXS69X18	2628	8967	£811.80	£974.16	£1,193.40	£1,432.08	£1,282.68	£1,539.22
	1540	19	VOXS69X19	2774	9465	£856.90	£1,028.28	£1,259.70	£1,511.64	£1,353.94	£1,624.73
	1620	20	VOXS69X20	2920	9963	£902.00	£1,082.40	£1,326.00	£1,591.20	£1,425.20	£1,710.24

23 RAL colours are shown on page 216

1646mm High

Height (mm)	Width (mm)	Sections	Model	Watts Δt 50°C	Btu's Δt 50°C	White		RAL Colours	RAL Colours	Special & Feature Finishes	
						Ex VAT	Inc VAT	Ex VAT	Inc VAT	Ex VAT	Inc VAT
DELIVERY TIMES						48-72 HOURS		UP TO 2 WEEKS		UP TO 2 WEEKS	
1646	260	3	VOXS16X3	813	2774	£408.03	£489.64	£599.79	£719.75	£644.70	£773.64
	340	4	VOXS16X4	1084	3699	£544.04	£652.85	£799.72	£959.66	£859.60	£1,031.52
	420	5	VOXS16X5	1355	4623	£680.05	£816.06	£999.65	£1,199.58	£1,074.50	£1,289.40
	500	6	VOXS16X6	1626	5548	£816.06	£979.27	£1,199.58	£1,439.50	£1,289.40	£1,547.28
	580	7	VOXS16X7	1897	6473	£952.07	£1,142.48	£1,399.51	£1,679.41	£1,504.30	£1,805.16
	660	8	VOXS16X8	2168	7397	£1,088.08	£1,305.70	£1,599.44	£1,919.33	£1,719.20	£2,063.04
	740	9	VOXS16X9	2439	8322	£1,224.09	£1,468.91	£1,799.37	£2,159.24	£1,934.10	£2,320.92
	820	10	VOXS16X10	2710	9247	£1,360.10	£1,632.12	£1,999.30	£2,399.16	£2,149.00	£2,578.80

23 RAL colours are shown on page 216

1846mm High

Height (mm)	Width (mm)	Sections	Model	Watts Δt 50°C	Btu's Δt 50°C	White		RAL Colours	RAL Colours	Special & Feature Finishes	
						Ex VAT	Inc VAT	Ex VAT	Inc VAT	Ex VAT	Inc VAT
DELIVERY TIMES						48-72 HOURS		UP TO 2 WEEKS		UP TO 2 WEEKS	
1846	260	3	VOXS18X3	891	3040	£444.75	£533.70	£653.79	£784.55	£702.72	£843.26
	340	4	VOXS18X4	1188	4053	£593.00	£711.60	£871.72	£1,046.06	£936.96	£1,124.35
	420	5	VOXS18X5	1485	5067	£741.25	£889.50	£1,089.65	£1,307.58	£1,171.20	£1,405.44
	500	6	VOXS18X6	1782	6080	£889.50	£1,067.40	£1,307.58	£1,569.10	£1,405.44	£1,686.53
	580	7	VOXS18X7	2079	7094	£1,037.75	£1,245.30	£1,525.51	£1,830.61	£1,639.68	£1,967.62
	660	8	VOXS18X8	2376	8107	£1,186.00	£1,423.20	£1,743.44	£2,092.13	£1,873.92	£2,248.70
	740	9	VOXS18X9	2673	9120	£1,334.25	£1,601.10	£1,961.37	£2,353.64	£2,108.16	£2,529.79
	820	10	VOXS18X10	2970	10134	£1,482.50	£1,779.00	£2,179.30	£2,615.16	£2,342.40	£2,810.88

23 RAL colours are shown on page 216

Widths include measurement for bushes

Quoted prices include plugs, bushes, air vent and wall brackets.

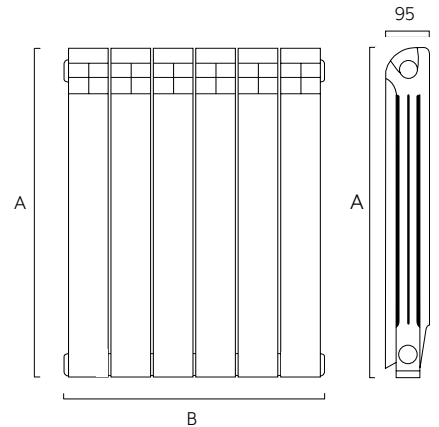

Pipe centres left to right	Pipe centres from wall	Depth from wall
width + valves	67mm to 71mm	114mm to 118mm

Feature Finishes

See page 7 for more details or call customer services for sample swatches.



Stock options by section RAL 9010

Outputs & price given per section, see page 174 for help on sizing your radiator or visit theradiatorcompany.co.uk where you will find our radiator builder.

Height (mm)	Width (mm)	Model	Watts Δt 50°C	Btu's Δt 50°C	White		RAL Colours	RAL Colours	Special & Feature Finishes		
					Ex VAT	Inc VAT	Ex VAT	Inc VAT	Ex VAT	Inc VAT	
DELIVERY TIMES						48-72 HOURS		UP TO 2 WEEKS		UP TO 2 WEEKS	
440	80	VOX44	95	324	£42.76	£51.31	£62.86	£75.43	£67.56	£81.07	
590		VOX59	127	433	£43.52	£52.22	£63.97	£76.76	£68.76	£82.51	
690		VOX69	146	498	£45.10	£54.12	£66.30	£79.56	£71.26	£85.51	
1646		VOX16	271	925	£136.01	£163.21	£199.93	£239.92	£214.90	£257.88	
1846		VOX18	297	1013	£148.25	£177.90	£217.93	£261.52	£234.24	£281.09	

23 RAL colours are shown on page 197

Pipe centres left to right	Pipe centres from wall	Depth from wall
number of sections x 80mm + 20mm bushes + valves	67mm to 71mm	114mm to 118mm

Note: Supplied pre-assembled in up to 20 sections (1600mm), wider radiators must be joined on site.

1646mm & 1846mm supplied pre-assembled in up to 10 sections (800mm), wider radiators must be joined on site.



High quality Italian design & manufacture.
Sectional Aluminium. CE/UKCA approved & certified to BS EN442.

White RAL 9010 as standard, 23 RAL colours, 31 Special Finishes & 6 Feature Finishes. Please call **01342 302250** for a RAL or Special Finish chart.
Colour Coordination Service available on stock sizes **see page 217** for full details.



Stock White RAL 9010: 48-72 Hours

Colours & Special / Feature Finishes: Up to 2 weeks.

Choose from our assembled stock options or build your own size by individual section, visit **theradiatorcompany.co.uk** to use our radiator builder.

Ideal TRV & Pipe Covers

SAVE £45*
WHEN YOU BUY OUR IDEAL TRV & PIPE COVERS WITH ANY DESIGNER PURCHASE. QUOTE **PROMOVI** AT TIME OF ORDER.

Available in White or Chrome.

Assembled stock options RAL 9010

390mm High

Height (mm)	Width (mm)	Sections	Model	Watts Δt 50°C	Btu's Δt 50°C	White		RAL Colours	RAL Colours	Special & Feature Finishes	
						Ex VAT	Inc VAT	Ex VAT	Inc VAT	Ex VAT	Inc VAT
DELIVERY TIMES						48-72 HOURS		UP TO 2 WEEKS		UP TO 2 WEEKS	
390	420	5	MIXS39X5	410	1399	£209.40	£251.28	£305.70	£366.84	£330.85	£397.02
	500	6	MIXS39X6	492	1679	£251.28	£301.54	£366.84	£440.21	£397.02	£476.42
	580	7	MIXS39X7	574	1958	£293.16	£351.79	£427.98	£513.58	£463.19	£555.83
	660	8	MIXS39X8	656	2238	£335.04	£402.05	£489.12	£586.94	£529.36	£635.23
	740	9	MIXS39X9	738	2518	£376.92	£452.30	£550.26	£660.31	£595.53	£714.64
	820	10	MIXS39X10	820	2798	£418.80	£502.56	£611.40	£733.68	£661.70	£794.04
	900	11	MIXS39X11	902	3078	£460.68	£552.82	£672.54	£807.05	£727.87	£873.44
	980	12	MIXS39X12	984	3357	£502.56	£603.07	£733.68	£880.42	£794.04	£952.85
	1060	13	MIXS39X13	1066	3637	£544.44	£653.33	£794.82	£953.78	£860.21	£1,032.25
	1140	14	MIXS39X14	1148	3917	£586.32	£703.58	£855.96	£1,027.15	£926.38	£1,111.66
	1220	15	MIXS39X15	1230	4197	£628.20	£753.84	£917.10	£1,100.52	£992.55	£1,191.06
	1300	16	MIXS39X16	1312	4477	£670.08	£804.10	£978.24	£1,173.89	£1,058.72	£1,270.46
	1380	17	MIXS39X17	1394	4756	£711.96	£854.35	£1,039.38	£1,247.26	£1,124.89	£1,349.87
	1460	18	MIXS39X18	1476	5036	£753.84	£904.61	£1,100.52	£1,320.62	£1,191.06	£1,429.27
1540	19	MIXS39X19	1558	5316	£795.72	£954.86	£1,161.66	£1,393.99	£1,257.23	£1,508.68	
1620	20	MIXS39X20	1640	5596	£837.60	£1,005.12	£1,222.80	£1,467.36	£1,323.40	£1,588.08	

23 RAL colours are shown on page 216

440mm High

Height (mm)	Width (mm)	Sections	Model	Watts Δt 50°C	Btu's Δt 50°C	White		RAL Colours	RAL Colours	Special & Feature Finishes	
						Ex VAT	Inc VAT	Ex VAT	Inc VAT	Ex VAT	Inc VAT
DELIVERY TIMES						48-72 HOURS		UP TO 2 WEEKS		UP TO 2 WEEKS	
440	420	5	MIXS44X5	470	1604	£213.80	£256.56	£312.15	£374.58	£337.80	£405.36
	500	6	MIXS44X6	564	1924	£256.56	£307.87	£374.58	£449.50	£405.36	£486.43
	580	7	MIXS44X7	658	2245	£299.32	£359.18	£437.01	£524.41	£472.92	£567.50
	660	8	MIXS44X8	752	2566	£342.08	£410.50	£499.44	£599.33	£540.48	£648.58
	740	9	MIXS44X9	846	2887	£384.84	£461.81	£561.87	£674.24	£608.04	£729.65
	820	10	MIXS44X10	940	3207	£427.60	£513.12	£624.30	£749.16	£675.60	£810.72
	900	11	MIXS44X11	1034	3528	£470.36	£564.43	£686.73	£824.08	£743.16	£891.79
	980	12	MIXS44X12	1128	3849	£513.12	£615.74	£749.16	£898.99	£810.72	£972.86
	1060	13	MIXS44X13	1222	4169	£555.88	£667.06	£811.59	£973.91	£878.28	£1,053.94
	1140	14	MIXS44X14	1316	4490	£598.64	£718.37	£874.02	£1,048.82	£945.84	£1,135.01
	1220	15	MIXS44X15	1410	4811	£641.40	£769.68	£936.45	£1,123.74	£1,013.40	£1,216.08
	1300	16	MIXS44X16	1504	5132	£684.16	£820.99	£998.88	£1,198.66	£1,080.96	£1,297.15
	1380	17	MIXS44X17	1598	5452	£726.92	£872.30	£1,061.31	£1,273.57	£1,148.52	£1,378.22
	1460	18	MIXS44X18	1692	5773	£769.68	£923.62	£1,123.74	£1,348.49	£1,216.08	£1,459.30
1540	19	MIXS44X19	1786	6094	£812.44	£974.93	£1,186.17	£1,423.40	£1,283.64	£1,540.37	
1620	20	MIXS44X20	1880	6415	£855.20	£1,026.24	£1,248.60	£1,498.32	£1,351.20	£1,621.44	

23 RAL colours are shown on page 216

Widths include measurement for bushes

Quoted prices include plugs, bushes, air vent and wall brackets.

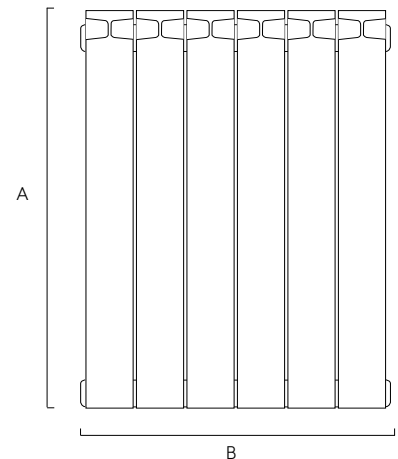
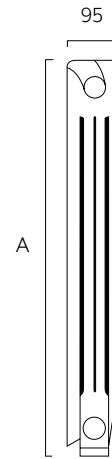

Pipe centres left to right	Pipe centres from wall	Depth from wall
width + valves	67mm to 71mm	114mm to 118mm

*Saving based on the value of individual items when bought separately. Order any of our selected valves & matching pipe covers at the same time as your radiator; PROMOVIW (white), PROMOVIC (chrome).

Assembled stock options RAL 9010

590mm High

Height (mm)	Width (mm)	Sections	Model	Watts Δt 50°C	Btu's Δt 50°C	White Ex VAT	White Inc VAT	RAL Colours Ex VAT	RAL Colours Inc VAT	Special & Feature Finishes Ex VAT	Special & Feature Finishes Inc VAT
DELIVERY TIMES						48-72 HOURS		UP TO 2 WEEKS		UP TO 2 WEEKS	
590	420	5	MIXS59X5	615	2098	£217.60	£261.12	£317.70	£381.24	£343.80	£412.56
	500	6	MIXS59X6	738	2518	£261.12	£313.34	£381.24	£457.49	£412.56	£495.07
	580	7	MIXS59X7	861	2938	£304.64	£365.57	£444.78	£533.74	£481.32	£577.58
	660	8	MIXS59X8	984	3357	£348.16	£417.79	£508.32	£609.98	£550.08	£660.10
	740	9	MIXS59X9	1107	3777	£391.68	£470.02	£571.86	£686.23	£618.84	£742.61
	820	10	MIXS59X10	1230	4197	£435.20	£522.24	£635.40	£762.48	£687.60	£825.12
	900	11	MIXS59X11	1353	4616	£478.72	£574.46	£698.94	£838.73	£756.36	£907.63
	980	12	MIXS59X12	1476	5036	£522.24	£626.69	£762.48	£914.98	£825.12	£990.14
	1060	13	MIXS59X13	1599	5456	£565.76	£678.91	£826.02	£991.22	£893.88	£1,072.66
	1140	14	MIXS59X14	1722	5875	£609.28	£731.14	£889.56	£1,067.47	£962.64	£1,155.17
	1220	15	MIXS59X15	1845	6295	£652.80	£783.36	£953.10	£1,143.72	£1,031.40	£1,237.68
	1300	16	MIXS59X16	1968	6715	£696.32	£835.58	£1,016.64	£1,219.97	£1,100.16	£1,320.19
	1380	17	MIXS59X17	2091	7134	£739.84	£887.81	£1,080.18	£1,296.22	£1,168.92	£1,402.70
	1460	18	MIXS59X18	2214	7554	£783.36	£940.03	£1,143.72	£1,372.46	£1,237.68	£1,485.22
	1540	19	MIXS59X19	2337	7974	£826.88	£992.26	£1,207.26	£1,448.71	£1,306.44	£1,567.73
	1620	20	MIXS59X20	2460	8394	£870.40	£1,044.48	£1,270.80	£1,524.96	£1,375.20	£1,650.24

23 RAL colours are shown on page 216

Widths include measurement for bushes

Quoted prices include plugs, bushes, air vent and wall brackets.

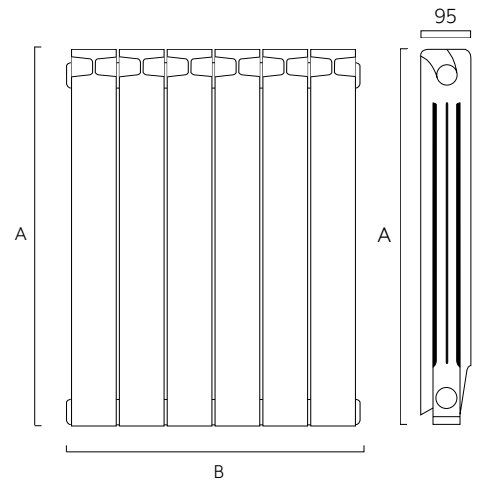

690mm High

Height (mm)	Width (mm)	Sections	Model	Watts Δt 50°C	Btu's Δt 50°C	White Ex VAT	White Inc VAT	RAL Colours Ex VAT	RAL Colours Inc VAT	Special & Feature Finishes Ex VAT	Special & Feature Finishes Inc VAT
DELIVERY TIMES						48-72 HOURS		UP TO 2 WEEKS		UP TO 2 WEEKS	
690	420	5	MIXS69X5	710	2423	£225.50	£270.60	£329.25	£395.10	£356.30	£427.56
	500	6	MIXS69X6	852	2907	£270.60	£324.72	£395.10	£474.12	£427.56	£513.07
	580	7	MIXS69X7	994	3392	£315.70	£378.84	£460.95	£553.14	£498.82	£598.58
	660	8	MIXS69X8	1136	3876	£360.80	£432.96	£526.80	£632.16	£570.08	£684.10
	740	9	MIXS69X9	1278	4361	£405.90	£487.08	£592.65	£711.18	£641.34	£769.61
	820	10	MIXS69X10	1420	4845	£451.00	£541.20	£658.50	£790.20	£712.60	£855.12
	900	11	MIXS69X11	1562	5330	£496.10	£595.32	£724.35	£869.22	£783.86	£940.63
	980	12	MIXS69X12	1704	5814	£541.20	£649.44	£790.20	£948.24	£855.12	£1,026.14
	1060	13	MIXS69X13	1846	6299	£586.30	£703.56	£856.05	£1,027.26	£926.38	£1,111.66
	1140	14	MIXS69X14	1988	6783	£631.40	£757.68	£921.90	£1,106.28	£997.64	£1,197.17
	1220	15	MIXS69X15	2130	7268	£676.50	£811.80	£987.75	£1,185.30	£1,068.90	£1,282.68
	1300	16	MIXS69X16	2272	7752	£721.60	£865.92	£1,053.60	£1,264.32	£1,140.16	£1,368.19
	1380	17	MIXS69X17	2414	8237	£766.70	£920.04	£1,119.45	£1,343.34	£1,211.42	£1,453.70
	1460	18	MIXS69X18	2556	8721	£811.80	£974.16	£1,185.30	£1,422.36	£1,282.68	£1,539.22
	1540	19	MIXS69X19	2698	9206	£856.90	£1,028.28	£1,251.15	£1,501.38	£1,353.94	£1,624.73
	1620	20	MIXS69X20	2840	9690	£902.00	£1,082.40	£1,317.00	£1,580.40	£1,425.20	£1,710.24

23 RAL colours are shown on page 216

Feature Finishes

See page 7 for more details or call customer services for sample swatches.

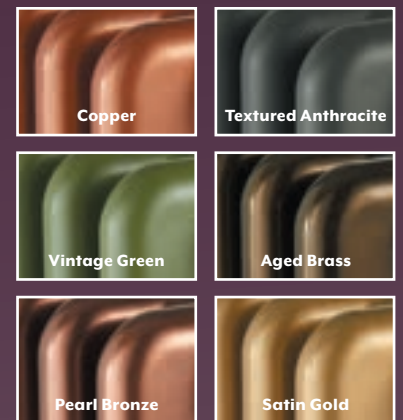

Stock options by section RAL 9010

Outputs & price given per section, see page 174 for help on sizing your radiator or visit theradiatorcompany.co.uk where you will find our radiator builder.

Height (mm)	Width (mm)	Model	Watts Δt 50°C	Btu's Δt 50°C	White Ex VAT	White Inc VAT	RAL Colours Ex VAT	RAL Colours Inc VAT	Special & Feature Finishes Ex VAT	Special & Feature Finishes Inc VAT	
DELIVERY TIMES						48-72 HOURS		UP TO 2 WEEKS		UP TO 2 WEEKS	
390	80	MIX39	82	280	£41.88	£50.26	£61.14	£73.37	£66.17	£79.40	
440		MIX44	94	321	£42.76	£51.31	£62.43	£74.92	£67.56	£81.07	
590		MIX59	123	420	£43.52	£52.22	£63.54	£76.25	£68.76	£82.51	
690		MIX69	142	485	£45.10	£54.12	£65.85	£79.02	£71.26	£85.51	

Note: Supplied pre-assembled in up to 20 sections (1600mm), wider radiators must be joined on site.

Pipe centres left to right	Pipe centres from wall	Depth from wall
number of sections x 80mm + 20mm bushes + valves	67mm to 71mm	114mm to 118mm

23 RAL colours available for your Aluminium radiator to be painted in see page 216 for full range.

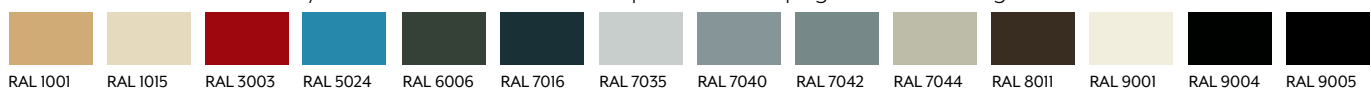

Our cast iron range includes a choice of ornate and plain schoolhouse designs. Available in a choice of finishes, including painted, polished and burnished, cast iron radiators can be specified by section so you can choose the right size for your space.



SAVE £45*

WHEN YOU BUY OUR **VINTAGE TRV KIT** WITH ANY CAST IRON PURCHASE. PLEASE QUOTE **PROMOV2** AT TIME OF ORDER.

*Saving based on the value of individual items when bought separately. Order any of our selected valves and matching pipe covers at the same time as your radiator.

Choose your radiator using our online radiator builder

Once you know your outputs use our **online radiator builder** to select the best solution for your room. It will take you through the process quickly and easily and allows you to save your ideas to your own Wish List. Go to our website theradiatorcompany.co.uk

It is vital to know the correct heat output you need to keep your room warm, use our online Heat Output Calculator to get a guide to your requirements which you can then check with your installer.



Once you know your outputs you can also use the brochure to specify your radiator by following these steps (or call our Customer Services team on 01342 302250 who will help you size your radiator)

- Note the space you have in mind for the radiator(s) you need; vertical or horizontal, length, height & depth
- Select a column option and height that fits your space; Calculate the number of sections you need by dividing the required BTU (Watt) output with the output per section; e.g 2400 BTUs divided by 300 = 8 sections, based on Ledbury 4 column, 660mm high sections (always round up to the next whole number of sections)
- If using that section size doesn't work in the space available, try a different column option or if possible a different height
- Once you have calculated the best number and size of section, select the best mounting option and kit; Footed End section or Cast Feet (for the Clifton, Ledbury, Wentworth and Henley only). Aston, Stamford and Linton ranges are only available with Footed Ends.
- Ledbury, Clifton, Henley & Wenworth radiators can be painted in a choice of 188 RAL colours, 10 classic cast iron finishes, a burnished or industrial finish plus Little Greene® & Farrow & Ball® Paints. The Aston can be painted in 188 RAL colours, a polished finish and Little Greene® & Farrow & Ball® Paints. The Linton and Stamford are available in 188 RAL colours, a polished finish (Linton only), a burnished finish, 4 special finishes as well as an Antique Brass or Galvanised Copper finish. Please specify your chosen colour at time of order. Please note: as a result of the casting process, cast iron radiators have a rough surface finish with small imperfections which will show after the painting process.
- Work out the price of your radiator; e.g *Ledbury 4 column, 660 high, 8 section, RAL 7044 Silk Grey* = £116.40 x 8 = £931.20 + a closed cast feet kit (2) £95.26 = £1026.46 Inc VAT
- Place your order with your local Merchant using the sectional model code x No. of sections needed, noting the mounting option and the name and number of colour you have chosen; e.g *LEDB4C660 x 8 sections, RAL 7044 Silk Grey with a closed Cast Feet kit*
- If you have chosen a colour make sure you list the colour number and name

All prices and outputs are given per section in the tables on pages 185-194. Price per section includes plugs, bushes and diverter. Mounting options must be selected separately, these will include the air vent and appropriate number of wall ties.

Joining Keys

Cast iron radiators come assembled up to a maximum of 10 sections. Radiators larger than these will require on-site assembly using a Joining Key.

- **The Heavy Duty Joining Key is available on a sale or return basis.**

Joining Keys must be specified at time of order for assistance please contact our Customer Service team on 01342 302250, they will also arrange a courier to collect it from you when you are ready.

Heavy Duty Joining Tool (includes tommy bar) engineered in the UK



Description	Model	Price Ex VAT	Price Inc VAT
DELIVERY TIMES		48-72 HOURS	
Heavy duty joining tool	PPASMT5	£557.00	£668.40

Cast Iron; 2, 3, 4 & 6 column, Footed Ends as standard
CE/UKCA approved & certified to BS EN442.



188 RAL colours and a Polished finish. Please call **01342 302250** for a RAL chart.
Little Greene® & Farrow & Ball® Paints available, prices on application, please call **01342 302250**.

All finishes: Up to 6 weeks
Please add 10 working days for orders of more than 10 radiators



SAVE £45*
WHEN YOU BUY OUR VINTAGE TRV & PIPE COVERS WITH ANY CAST IRON PURCHASE.
QUOTE PROMOV2 AT TIME OF ORDER.

For all Vintage TRV finishes see page 122

Aston Sectional options with Footed End sections as standard

Build your radiator to fit your requirements using individual sections shown below, visit page 184 to help you size your radiator.
Please note section prices are based on 6 sections or more, for anything less than 6 sections prices will be on application.
If you require more than 40 sections please contact our Customer Services team on **01342 302250**.

2 Column

Height A (mm)	Width B (mm)	Model	Watts Δt 50°C	Btu's Δt 50°C	RAL Colours Ex VAT	RAL Colours Inc VAT	Polished Ex VAT	Polished Inc VAT
DELIVERY TIMES					UP TO 6 WEEKS		UP TO 6 WEEKS	
460	59	ASTO2C46	35	119	£53.49	£64.19	£109.99	£131.99
760	59	ASTO2C76	59	201	£59.72	£71.66	£116.84	£140.21
960	59	ASTO2C96	74	252	£65.99	£79.19	£122.88	£147.46

3 Column

Height A (mm)	Width B (mm)	Model	Watts Δt 50°C	Btu's Δt 50°C	RAL Colours Ex VAT	RAL Colours Inc VAT	Polished Ex VAT	Polished Inc VAT
DELIVERY TIMES					UP TO 6 WEEKS		UP TO 6 WEEKS	
560	59	ASTO3C56	54	184	£68.87	£82.64	£125.79	£150.95
660	59	ASTO3C66	66	225	£75.26	£90.31	£132.38	£158.86
760	59	ASTO3C76	78	266	£81.73	£98.08	£139.09	£166.91
860	59	ASTO3C86	87	297	£88.55	£106.26	£145.27	£174.32

4 Column

Height A (mm)	Width B (mm)	Model	Watts Δt 50°C	Btu's Δt 50°C	RAL Colours Ex VAT	RAL Colours Inc VAT	Polished Ex VAT	Polished Inc VAT
DELIVERY TIMES					UP TO 6 WEEKS		UP TO 6 WEEKS	
360	59	ASTO4C36	45	154	£72.61	£87.13	£129.30	£155.16
460	59	ASTO4C46	58	198	£78.88	£94.66	£136.09	£163.31
560	59	ASTO4C56	69	235	£84.39	£101.27	£142.57	£171.08
760	59	ASTO4C76	96	328	£94.37	£113.24	£150.62	£180.74
860	59	ASTO4C86	109	372	£99.99	£119.99	£157.07	£188.48
960	59	ASTO4C96	121	413	£106.44	£127.73	£163.94	£196.73

6 Column

Height A (mm)	Width B (mm)	Model	Watts Δt 50°C	Btu's Δt 50°C	RAL Colours Ex VAT	RAL Colours Inc VAT	Polished Ex VAT	Polished Inc VAT
DELIVERY TIMES					UP TO 6 WEEKS		UP TO 6 WEEKS	
960	59	ASTO6C96	168	573	£141.65	£169.98	£197.54	£237.05

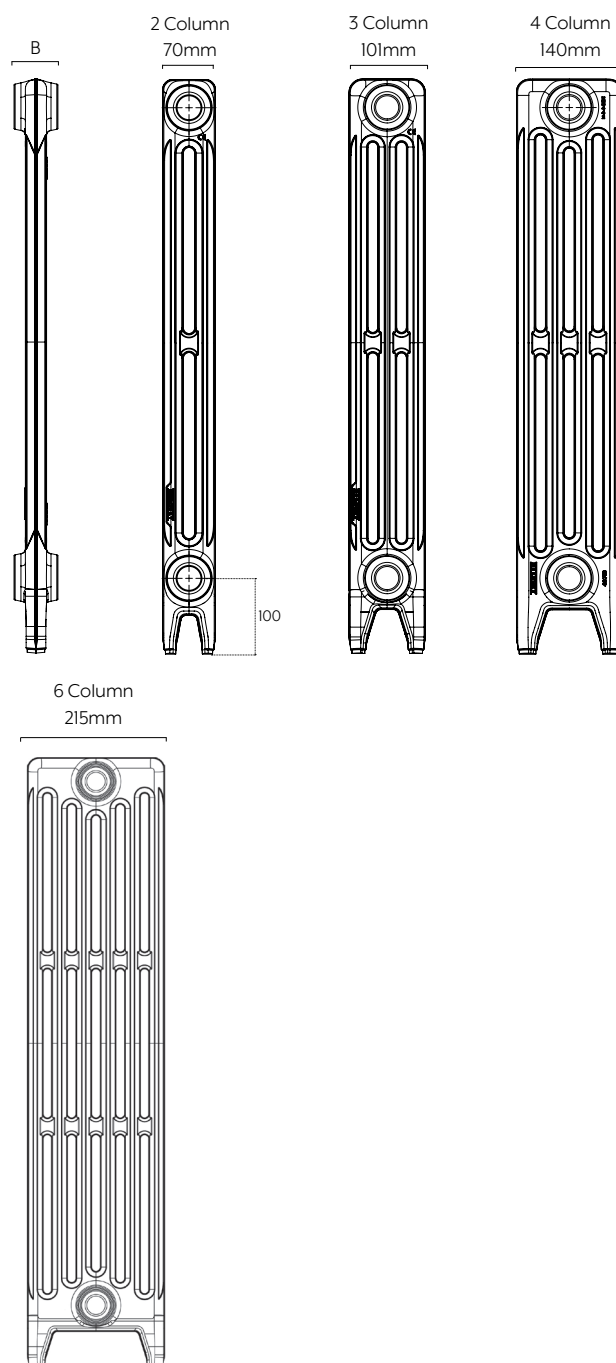

Aston	Pipe centres left to right	Pipe centres from wall
2 Column	58.5 x number of sections + 25mm bushes + valves	68mm to 83mm
3 Column	58.5 x number of sections + 25mm bushes + valves	84mm to 99mm
4 Column	58.5 x number of sections + 25mm bushes + valves	103mm to 118mm
6 Column	58.5 x number of sections + 25mm bushes + valves	140mm to 155mm

*Saving based on the value of individual items when bought separately. Order any of our selected valves and matching pipe covers at the same time as your radiator.

Ledbury shown on pages 74-75

Cast Iron; 4 or 6 column footed ends as standard, optional cast feet
CE/UKCA approved & certified to BS EN442.



Supplied in RAL 7038 Agate Grey primer, ready to be painted in your desired finish.
188 RAL colours, 10 Classic Cast Iron Colours, Industrial or Burnished Finishes.
Please call **01342 302250** for samples of finishes.

Little Greene® & Farrow & Ball® Paints available, prices on application, please call **01342 302250**.

Primer, RAL, Classic Cast Iron Colours, Farrow & Ball® & Little Greene®: Up to 3 weeks
Industrial & Burnished Finishes: Up to 6 weeks.

Available with Footed End sections as standard, Cast Feet are also available. Please see alternative mounting options on page 189 or call customer services on **01342 302250** for more information and prices.

Build your radiator to fit your requirements using individual sections shown below, visit page 184 to help you size your radiator.
Please note section prices are based on 6 sections or more, for anything less than 6 sections prices will be on application.
If you require more than 40 sections please contact our Customer Services team on **01342 302250**.



Vintage TRV & Pipe Covers 

SAVE £45*
WHEN YOU BUY OUR VINTAGE TRV & PIPE COVERS WITH ANY CAST IRON PURCHASE.
QUOTE **PROMOV2** AT TIME OF ORDER.

For all Vintage TRV finishes see page 122

4 Column - Primer, RAL Colours and Classic Cast Iron Colours

Height A (mm)	Width B (mm)	Model	Watts Δt 50°C	Btu's Δt 50°C	Primer Ex VAT	Primer Inc VAT	Colours Ex VAT	Colours Inc VAT
DELIVERY TIMES			UP TO 3 WEEKS					
360	61	LEDB4C360	47	160	£68.00	£81.60	£80.00	£96.00
505	61	LEDB4C505	67	229	£76.00	£91.20	£88.00	£105.60
660	61	LEDB4C660	88	300	£86.00	£103.20	£97.00	£116.40
760	61	LEDB4C760	107	365	£94.00	£112.80	£106.00	£127.20
960	61	LEDB4C960	127	433	£109.00	£130.80	£121.00	£145.20

Please specify your finish at time of order, delivered in up to 3 weeks

6 Column - Primer, RAL Colours and Classic Cast Iron Colours

Height A (mm)	Width B (mm)	Model	Watts Δt 50°C	Btu's Δt 50°C	Primer Ex VAT	Primer Inc VAT	Colours Ex VAT	Colours Inc VAT
DELIVERY TIMES			UP TO 3 WEEKS					
505	61	LEDB6C505	97	331	£94.00	£112.80	£106.00	£127.20
660	61	LEDB6C660	127	433	£112.00	£134.40	£124.00	£148.80
960	61	LEDB6C960	182	621	£151.00	£181.20	£162.00	£194.40

Please specify your finish at time of order, delivered in up to 3 weeks

4 Column - Burnished and Industrial Finishes

Height A (mm)	Width B (mm)	Model	Watts Δt 50°C	Btu's Δt 50°C	Burnished Ex VAT	Burnished Inc VAT	Industrial Ex VAT	Industrial Inc VAT
DELIVERY TIMES			UP TO 6 WEEKS					
360	61	LEDB4C360	47	160	£114.00	£136.80	£114.00	£136.80
505	61	LEDB4C505	67	229	£122.00	£146.40	£122.00	£146.40
660	61	LEDB4C660	88	300	£132.00	£158.40	£132.00	£158.40
760	61	LEDB4C760	107	365	£141.00	£169.20	£141.00	£169.20

Please specify your finish at time of order, delivered in up to 6 weeks

6 Column - Burnished and Industrial Finishes

Height A (mm)	Width B (mm)	Model	Watts Δt 50°C	Btu's Δt 50°C	Burnished Ex VAT	Burnished Inc VAT	Industrial Ex VAT	Industrial Inc VAT
DELIVERY TIMES			UP TO 6 WEEKS					
505	61	LEDB6C505	97	331	£141.00	£169.20	£141.00	£169.20
660	61	LEDB6C660	127	433	£159.00	£190.80	£159.00	£190.80

Please specify your finish at time of order, delivered in up to 6 weeks

Please Note this is a new version of the Ledbury, there are minor technical and visual differences between this, and the previous version. The range of heights have changed and there is a small reduction of 1mm per section in pipe centres. Please contact our customer services team for guidance.

Classic Cast Iron Colours



For samples of our Classic Cast Iron colours please call **01342 302250**.

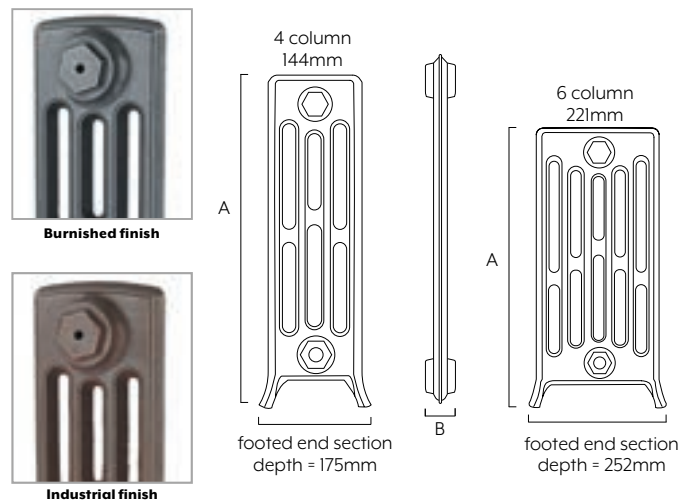

Ledbury	Pipe centres left to right	Footed End section depth
4 Column	61 x number of sections + 26mm bushes + valves	175mm (footed ends protrude 31mm total from section width)
6 Column	61 x number of sections + 26mm bushes + valves	252mm (footed ends protrude 31mm total from section width)

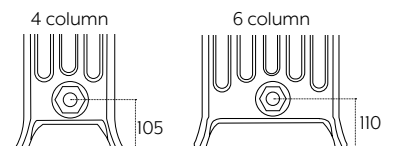

Please note for sections without Footed Ends deduct 60mm from the height of the section.

*Saving based on the value of individual items when bought separately. Order any of our selected valves & matching pipe covers at the same time as your radiator.

Colours & Finishes for the Clifton, Ledbury, Henley & Wentworth ranges

Classic Cast Iron Colours

We have a new range of classic cast iron colours on a selection of our cast iron models, these specially selected colours reflect the heritage and traditions of cast iron from Victorian times to the modern day. Chosen with an eye on classic interiors these tough hard wearing & washable finishes add a stunning metallic look to your cast iron radiators. Our selection of darker colours such as Iron Ore, Lead Grey and Factory Black are amongst the most popular choices along with the deep dark bronze of Vintage Coin and Classic Bronze. The range of Gold's & Copper are perfect for a more rich and bold statement. The finish of the durable polyurethane, wet paint is equivalent to an Eggshell that sits well on the rough texture of cast Iron. For samples please call **01342 302250**.



Burnished finish on Henley



Industrial finish on Wentworth

Burnished & Industrial Finishes

A selection of our cast iron ranges are available in a beautiful, burnished finish. Created by hand in the UK, this process involves multiple stages; first a complete coat of black paint is applied to protect hidden, hard to access areas of the radiator and to provide a highlight for the visible polished areas. Then we polish the front, sides & tops of the sections, whilst the rear & more difficult to access areas between the sections (circa 2/3rds to 3/4s of the back, and the bottom) will remain black. Finally, a clear lacquer is applied to protect and maintain this exquisite finish.

188 RAL Colours

Our Cast Iron designs are available in a large selection of RAL colours, 188 internationally recognised paint colours. Colour can add an extra element of individual style and design, creating a personal and unique result, you can select from a wide range of colours. For a RAL chart please call **01342 302250**.



RAL 1015 - Light Ivory



RAL 7016 - Anthracite Grey

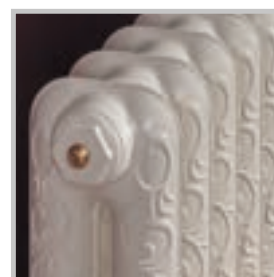

RAL 9001 - Cream

Little Greene®
— PAINT & PAPER —

FARROW & BALL®
HANDCRAFTED PAINT AND WALLPAPER

We are able to offer our Ledbury, Clifton, Henley and Wentworth in any one of Farrow & Ball's® or Little Greene's® stunning range of quality paints, a perfect match for any heritage property. They add a classic high quality finish to your radiator that will perfectly match your chosen colour. We only use genuine Farrow & Ball® or Little Greene® paints, for Farrow & Ball® we use their Estate Eggshell (20% sheen), and for Little Greene®, we use their Tom's Oil Eggshell (15% gloss).

The process is very straightforward, simply specify the colour name and reference number along with the radiator range and size and we will provide you with a quotation. Once approved we will order the paint and produce your radiators.

Please do note that (especially with Little Greene®) the reference number is extremely important. Little Greene's palette of 196 colours includes the 'Colour Scales' which offer graduated shades from the same family of pigments. Therefore, similar names have been given, with a colour number for each. Prices and lead times are available on application (please call 01342 302250 for more details).

Clifton shown on pages 78-79 New

Cast Iron; Footed Ends as standard, optional Cast Feet
CE/UKCA approved & certified to BS EN442.



Supplied in a black primer, ready to be painted in your desired finish.
188 RAL colours, 10 Classic Cast Iron Colours, Industrial or Burnished Finishes.
Please call **01342 302250** for samples of finishes.

Little Greene® & Farrow & Ball® Paints available, prices on application, please call **01342 302250**.

Primer, RAL, Classic Cast Iron Colours, Farrow & Ball® & Little Greene®: Up to 3 weeks
Industrial & Burnished Finishes: Up to 6 weeks.



Vintage TRV & Pipe Covers

SAVE £45*

WHEN YOU BUY OUR VINTAGE TRV & PIPE COVERS WITH ANY CAST IRON PURCHASE. QUOTE **PROMOV2** AT TIME OF ORDER.

For all Vintage TRV finishes see page 122

Available with Footed End sections as standard, Cast Feet are also available. Please see alternative mounting options on page 189 or call customer services on **01342 302250** for more information and prices.

Build your radiator to fit your requirements using individual sections shown below, visit page 184 to help you size your radiator.
Please note section prices are based on 6 sections or more, for anything less than 6 sections prices will be on application.
If you require more than 40 sections please contact our Customer Services team on **01342 302250**.

Primer, RAL Colours and Classic Cast Iron Colours

Height A (mm)	Width B (mm)	Model	Watts Δt 50°C	Btu's Δt 50°C	Primer Ex VAT	Primer Inc VAT	Colours Ex VAT	Colours Inc VAT
DELIVERY TIMES			UP TO 3 WEEKS					
440	65	CLIF440	50	171	£85.00	£102.00	£97.00	£116.40
740	65	CLIF740	82	280	£114.00	£136.80	£125.00	£150.00

Please specify your finish at time of order, delivered in up to 3 weeks

Classic Cast Iron Colours



For samples of our Classic Cast Iron colours please call **01342 302250**.

Burnished and Industrial Finishes

Height A (mm)	Width B (mm)	Model	Watts Δt 50°C	Btu's Δt 50°C	Burnished Ex VAT	Burnished Inc VAT	Industrial Ex VAT	Industrial Inc VAT
DELIVERY TIMES			UP TO 6 WEEKS					
440	65	CLIF440	50	171	£132.00	£158.40	£132.00	£158.40
740	65	CLIF740	82	280	£160.00	£192.00	£160.00	£192.00

Please specify your finish at time of order, delivered in up to 6 weeks



Pipe centres left to right	Pipe centres from wall
65 x number of sections + 34mm bushes + valves	As a free standing radiator, pipe centres depend on final position.

Please note for sections without Footed Ends deduct 65mm from the height of the section.

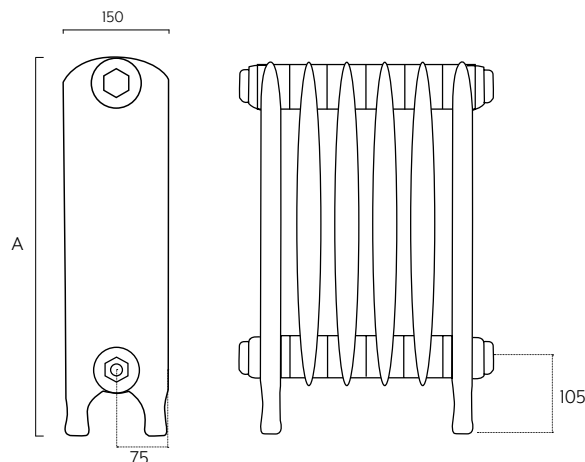

Any quoted lengths are provided for guidance only. Due to the nature, and production process of these radiators, tolerances are to be expected and we strongly advise to always have the actual product on-site prior to any pipe-work being installed.

*Saving based on the value of individual items when bought separately. Order any of our selected valves & matching pipe covers at the same time as your radiator.

Optional Cast Feet for Ledbury, Clifton, Henley & Wentworth Radiators

If you require optional Cast Feet please specify at time of order by adding the relevant kit & price below. Choose below from an open or closed design.

Up to 20 Sections	21 - 39 Sections (odd number of sections)	22 - 40 Sections (even number of sections)
2 Feet - 1 at each end	3 Feet - 1 at each end and 1 positioned centrally	4 Feet - 1 at each end and 2 spaced equally inbetween
2 Wall Ties	3 Wall Ties	4 Wall Ties

Wall Ties are included in the price and supplied as standard for all orders. Please specify your chosen mounting option at time of order.

Open Cast Foot

Model	Number of Feet	Primer Ex VAT	Primer Inc VAT	Colours Ex VAT	Colours Inc VAT
DELIVERY TIMES		UP TO 3 WEEKS		UP TO 3 WEEKS	
PPCFOPKIT2	2	£49.00	£58.80	£79.38	£95.26
PPCFOPKIT3	3	£77.00	£92.40	£124.74	£149.69
PPCFOPKIT4	4	£103.00	£123.60	£166.86	£200.23

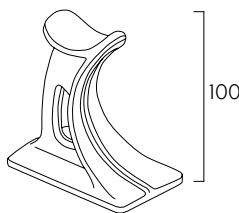

Please remember to add 100mm to the height of the Ledbury, Clifton, Henley & Wentworth section you have chosen if you are using Cast Feet.

Please specify finish at time of order

Closed Cast Foot

Model	Number of Feet	Primer Ex VAT	Primer Inc VAT	Colours Ex VAT	Colours Inc VAT
DELIVERY TIMES		UP TO 3 WEEKS		UP TO 3 WEEKS	
PPCFCLKIT2	2	£49.00	£58.80	£79.38	£95.26
PPCFCLKIT3	3	£77.00	£92.40	£124.74	£149.69
PPCFCLKIT4	4	£103.00	£123.60	£166.86	£200.23

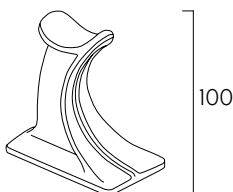

Please remember to add 100mm to the height of the Ledbury, Clifton, Henley & Wentworth section you have chosen if you are using Cast Feet.

Please specify finish at time of order

If you require additional Cast Feet or Wall Ties please see pricing table below and specify at time of order

Description	Model	Primer Ex VAT	Primer Inc VAT	Colours Ex VAT	Colours Inc VAT
DELIVERY TIMES		UP TO 3 WEEKS		UP TO 3 WEEKS	
Closed Cast foot (each)	PPCIFM01	£22.00	£26.40	£38.06	£45.67
Open Cast foot (each)	PPANSFM01	£22.00	£26.40	£38.06	£45.67
Wall tie (each)	PPCIWT01	£5.00	£6.00	N/A	N/A

Please Note: Individual feet can only be ordered at the same time you order your painted radiator and can not be purchased separately

Solid Brass Cast Iron Wall Ties & Airvents for Ledbury, Clifton, Henley & Wentworth

These solid brass wall ties provide a stylish finishing touch to any cast iron radiator; select to match your valves. Available as a kit including matching airvent in Antique Brass, Chrome and Brushed Nickel. Please note that these Wall Ties and airvents are an optional extra and do not come as standard with your cast iron radiator.

Description	Model	Number of Wall Ties	Number of Airvents	Price Ex VAT	Price Inc VAT
DELIVERY TIMES				48-72 HOURS	
Single Wall Tie	PPCIWT	1	N/A	£68.00	£81.60
Single Airvent	PPLAVP	N/A	1	£20.00	£24.00
Wall Tie & Airvent Kit	PPCIPWTAVKIT2	2	1	£150.00	£180.00
Wall Tie & Airvent Kit	PPCIPWTAVKIT3	3	1	£215.00	£258.00
Wall Tie & Airvent Kit	PPCIPWTAVKIT4	4	1	£280.00	£336.00
Wall Tie & Airvent Kit	PPCIPWTAVKIT5	5	1	£345.00	£414.00

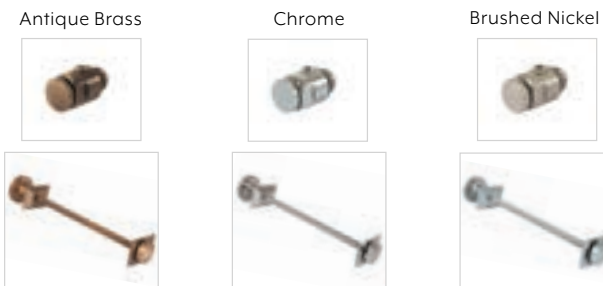

Please specify finish at time of order

Solid Brass Cast Iron Wall Ties & Airvents for Aston, Stamford & Linton

These solid brass wall ties provide a stylish finishing touch to any cast iron radiator; select to match your valves. Available as a kit including matching airvent in Antique Brass, Chrome and Brushed Nickel. Please note that these Wall Ties and airvents are an optional extra and do not come as standard with your cast iron radiator.

Description	Model	Number of Wall Ties	Number of Airvents	Price Ex VAT	Price Inc VAT
DELIVERY TIMES				48-72 HOURS	
Single Wall Tie	PPCIWT	1	N/A	£68.00	£81.60
Single Airvent	PPLAV	N/A	1	£12.00	£14.40
Wall Tie & Airvent Kit	PPCIWTAVKIT2	2	1	£143.00	£171.60
Wall Tie & Airvent Kit	PPCIWTAVKIT3	3	1	£205.00	£246.00
Wall Tie & Airvent Kit	PPCIWTAVKIT4	4	1	£270.00	£324.00
Wall Tie & Airvent Kit	PPCIWTAVKIT5	5	1	£334.00	£400.80

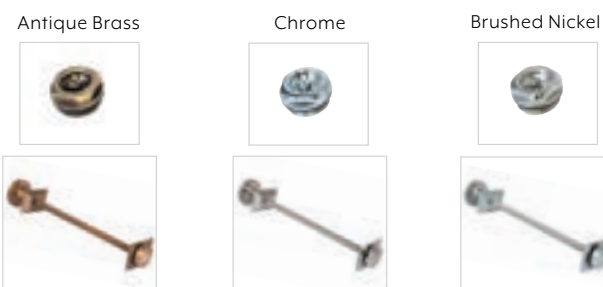

Please specify finish at time of order

Linton shown on pages 80-81

Cast Iron; 2 or 3 column Footed Ends only
CE/UKCA approved & certified to BS EN442.

188 RAL colours, 4 special finishes, Polished & Burnished finishes
plus 1 Galvanised finish (details below).
Please call **01342 302250** for a RAL chart.

Made to order: RAL colours, Soft Gold, Slate Grey, Flat Black up to 5 weeks.
Antique Brass, Burnished, Galvanised Copper & Polished up to 7 weeks.
Please add 10 working days for orders of more than 10 radiators.

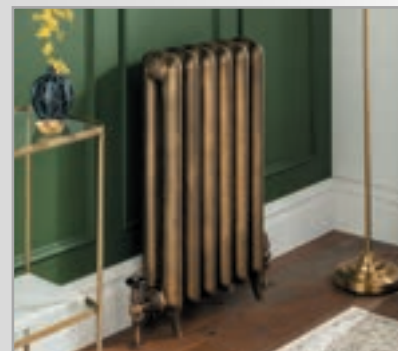

Vintage TRV & Pipe Covers 

SAVE £45*
WHEN YOU BUY OUR VINTAGE TRV & PIPE COVERS WITH ANY CAST IRON PURCHASE.
QUOTE **PROMOV2** AT TIME OF ORDER.

For all Vintage TRV finishes see page 122

Build your radiator to fit your requirements using individual sections shown below,
visit page 184 to help you size your radiator.

If you require more than 40 sections please contact our Customer Services team on **01342 302250**.

RAL & Special Finishes (Soft Gold, Slate Grey, Flat Black)

2 Column

Height A (mm)	Width B (mm)	Model	Watts Δt 50°C	Btu's Δt 50°C	RAL Colours Ex VAT	RAL Colours Inc VAT	Special Finishes Ex VAT	Special Finishes Inc VAT
DELIVERY TIMES					UP TO 5 WEEKS		UP TO 5 WEEKS	
521	82	LINT2C521	86	293	£142.96	£171.55	£153.46	£184.15
621	82	LINT2C621	103	351	£162.65	£195.18	£177.06	£212.47
721	82	LINT2C721	124	423	£188.29	£225.95	£186.25	£223.50
921	82	LINT2C921	161	549	£200.68	£240.82	£211.17	£253.40

3 Column

Height A (mm)	Width B (mm)	Model	Watts Δt 50°C	Btu's Δt 50°C	RAL Colours Ex VAT	RAL Colours Inc VAT	Special Finishes Ex VAT	Special Finishes Inc VAT
DELIVERY TIMES					UP TO 5 WEEKS		UP TO 5 WEEKS	
621	82	LINT3C621	119	406	£194.11	£232.93	£200.68	£240.82
721	82	LINT3C721	138	471	£201.99	£242.39	£236.09	£283.31
921	82	LINT3C921	176	601	£243.96	£292.75	£275.44	£330.53



Soft Gold

Slate Grey

Flat Black

Please specify your finish at time of order, delivery time is 5 weeks

Burnished & Polished Finishes

2 Column

Height A (mm)	Width B (mm)	Model	Watts Δt 50°C	Btu's Δt 50°C	Burnished Ex VAT	Burnished Inc VAT	Polished Ex VAT	Polished Inc VAT
DELIVERY TIMES					UP TO 7 WEEKS		UP TO 7 WEEKS	
521	82	LINT2C521	86	293	£161.32	£193.58	£166.57	£199.88
621	82	LINT2C621	103	351	£187.56	£225.07	£195.42	£234.50
721	82	LINT2C721	124	423	£196.74	£236.09	£220.34	£264.41
921	82	LINT2C921	161	549	£234.78	£281.74	£279.37	£335.24

3 Column

Height A (mm)	Width B (mm)	Model	Watts Δt 50°C	Btu's Δt 50°C	Burnished Ex VAT	Burnished Inc VAT	Polished Ex VAT	Polished Inc VAT
DELIVERY TIMES					UP TO 7 WEEKS		UP TO 7 WEEKS	
621	82	LINT3C621	119	406	£213.79	£256.55	£259.70	£311.64
721	82	LINT3C721	138	471	£253.13	£303.76	£308.23	£369.88
921	82	LINT3C921	176	601	£293.80	£352.56	£354.13	£424.96



Burnished

Polished

Please specify your finish at time of order, delivery time is 7 weeks for Burnished and 7 weeks for Polished.

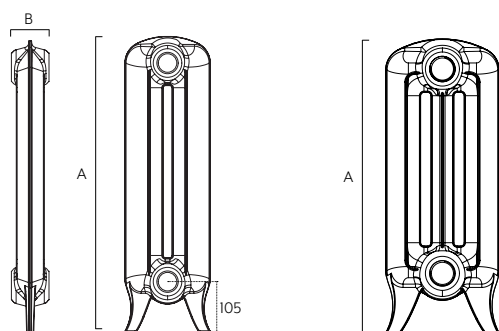

Linton	Pipe centres left to right	Pipe centres from wall	Depth from wall
2 Column	82 x number of sections + 32mm + valves	120mm	210mm
3 Column	82 x number of sections + 32mm + valves	130mm	230mm

*Saving based on the value of individual items when bought separately. Order any of our selected valves & matching pipe covers at the same time as your radiator.

Antique Brass & Galvanised Finish Antique Copper

If selecting Antique Brass please read the below about the finish.

2 Column

Height A (mm)	Width B (mm)	Model	Watts Δt 50°C	Btu's Δt 50°C	Antique Brass Ex VAT	Antique Brass Inc VAT	Galvanised Copper Ex VAT	Galvanised Copper Inc VAT
DELIVERY TIMES					UP TO 7 WEEKS		UP TO 7 WEEKS	
521	82	LINT2C521	86	293	£221.66	£265.99	£238.71	£286.45
621	82	LINT2C621	103	351	£257.41	£284.89	£263.63	£316.36
721	82	LINT2C721	124	423	£254.45	£305.34	£281.99	£338.39
921	82	LINT2C921	161	549	£296.42	£355.70	£348.88	£418.66

3 Column

Height A (mm)	Width B (mm)	Model	Watts Δt 50°C	Btu's Δt 50°C	Antique Brass Ex VAT	Antique Brass Inc VAT	Galvanised Copper Ex VAT	Galvanised Copper Inc VAT
DELIVERY TIMES					UP TO 7 WEEKS		UP TO 7 WEEKS	
621	82	LINT3C621	119	406	£267.56	£321.07	£295.10	£354.12
721	82	LINT3C721	138	471	£309.53	£371.44	£348.88	£418.66
921	82	LINT3C921	176	601	£364.63	£437.56	£428.89	£514.67

Please specify your finish at time of order, delivery time is 7 weeks for Antique Brass and Galvanised Antique Copper.



Galvanised Copper



Antique Brass

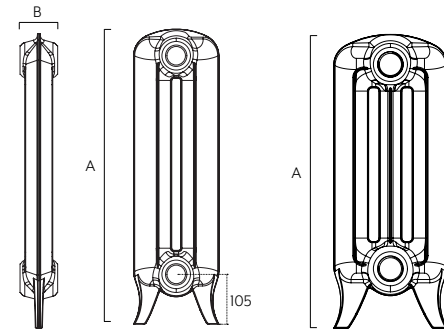

Linton	Pipe centres left to right	Pipe centres from wall	Depth from wall
2 Column	82 x number of sections + 32mm + valves	120mm	210mm
3 Column	82 x number of sections + 32mm + valves	130mm	230mm

Antique Brass Finish

Cast iron is a classic favourite, loved for its traditional qualities and style. Part of the charm of cast iron is the inherent imperfections and idiosyncrasies in the metal produced by the traditional production methods. Newly cast product retains the texture and individuality of radiators cast over 100 years ago, but in order to create an aged appearance to the finish, they go through a number of stages ending with a hand-finished application.

The appeal of an antique product is its unique patina developed over time, each radiator will differ, and so to reproduce that effect our Antique finishes will have a varying depth of light and dark across the radiator.

After cleaning, priming and the application of the brass effect powder coat each radiator has an antique rub applied by hand. This is then rubbed down and baked to fix the protective surface. The level and amount of light and dark differ from section to section as the combination of texture, casting marks and the random nature of hand finishing produces a striking and unique antiqued finish.

Casting marks and textures retain the antique topcoat, highlighting the natural surface texture of the cast metal

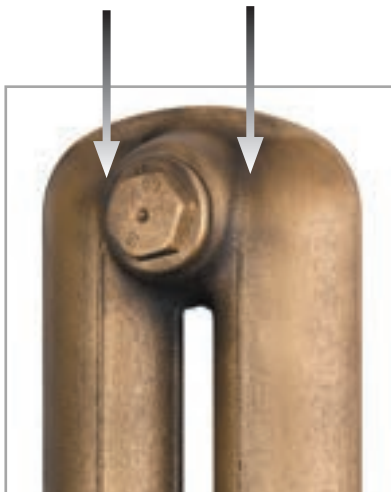

Darker areas occur when hard to access areas and mould patterns retain more of the antique rub, creating an individual final finish.

Henley shown on pages 82-83 New

Cast Iron; 3 column, Footed Ends as standard, optional Cast Feet
CE/UKCA approved & certified to BS EN442.



Supplied in a black primer, ready to be painted in your desired finish
188 RAL colours, 10 Classic Cast Iron Colours, Industrial or Burnished Finishes.
Please call **01342 302250** for samples of finishes.

Little Greene® & Farrow & Ball® Paints available, prices on application, please call **01342 302250**.

Primer, RAL, Classic Cast Iron Colours, Farrow & Ball® & Little Greene®: Up to 3 weeks
Industrial & Burnished Finishes: Up to 6 weeks.

Vintage TRV & Pipe Covers

SAVE £45*
WHEN YOU BUY OUR VINTAGE TRV & PIPE COVERS WITH ANY CAST IRON PURCHASE. QUOTE **PROMOV2** AT TIME OF ORDER.

For all Vintage TRV finishes see page 122

Available with Footed End sections as standard, Cast Feet are also available. Please see alternative mounting options on page 189 or call customer services on **01342 302250** for more information and prices.

Build your radiator to fit your requirements using individual sections shown below, visit page 184 to help you size your radiator.
Please note section prices are based on 6 sections or more, for anything less than 6 sections prices will be on application.
If you require more than 40 sections please contact our Customer Services team on **01342 302250**.

Primer, RAL Colours and Classic Cast Iron Colours

Height A (mm)	Width B (mm)	Model	Watts Δt 50°C	Btu's Δt 50°C	Primer Ex VAT	Primer Inc VAT	Colours Ex VAT	Colours Inc VAT
DELIVERY TIMES			UP TO 3 WEEKS					
470	81	HENL3C470	95	324	£112.00	£134.40	£124.00	£148.80
570	81	HENL3C570	115	392	£124.00	£148.80	£136.00	£163.20
765	81	HENL3C765	156	532	£142.00	£170.40	£154.00	£184.80

Please specify your finish at time of order, delivered in up to 3 weeks

Classic Cast Iron Colours



For samples of our Classic Cast Iron colours please call **01342 302250**.

Burnished and Industrial Finishes

Height A (mm)	Width B (mm)	Model	Watts Δt 50°C	Btu's Δt 50°C	Burnished Ex VAT	Burnished Inc VAT	Industrial Ex VAT	Industrial Inc VAT
DELIVERY TIMES			UP TO 6 WEEKS					
470	81	HENL3C470	95	324	£159.00	£190.80	£159.00	£190.80
570	81	HENL3C570	115	392	£170.00	£204.00	£170.00	£204.00
765	81	HENL3C765	156	532	£189.00	£226.80	£189.00	£226.80

Please specify your finish at time of order, delivered in up to 6 weeks



Burnished finish

Industrial finish (Wentworth)

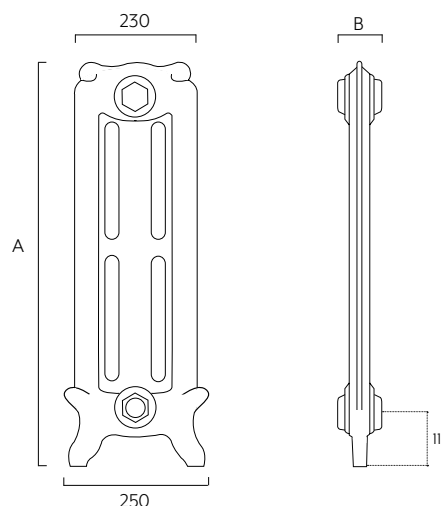

Pipe centres left to right	Footed End section depth	Pipe centres from wall
81 x number of sections + 34mm bushes + valves	250mm (footed ends protrude 20mm total from section depth)	As a free standing radiator, pipe centres depend on final position.

Please note for sections without Footed Ends deduct 45mm from the height of the section.

Any quoted lengths are provided for guidance only. Due to the nature, and production process of these radiators, tolerances are to be expected and we strongly advise to always have the actual product on-site prior to any pipe-work being installed.

*Saving based on the value of individual items when bought separately. Order any of our selected valves & matching pipe covers at the same time as your radiator.

Cast Iron; 2 column, Footed Ends as standard, optional Cast Feet
CE/UKCA approved & certified to BS EN442.



Supplied in a black primer, ready to be painted in your desired finish
188 RAL colours, 10 Classic Cast Iron Colours, Industrial or Burnished Finishes.
Please call **01342 302250** for samples of finishes.

Little Greene® & Farrow & Ball® Paints available, prices on application, please call **01342 302250**.

Primer, RAL, Classic Cast Iron Colours, Farrow & Ball® & Little Greene®: Up to 3 weeks
Industrial & Burnished Finishes: Up to 6 weeks.



SAVE £45*
WHEN YOU BUY OUR VINTAGE TRV & PIPE
COVERS WITH ANY CAST IRON PURCHASE.
QUOTE **PROMOV2** AT TIME OF ORDER.

For all Vintage TRV finishes see page 122

Build your radiator to fit your requirements using individual sections shown below, visit page 184 to help you size your radiator. Please note section prices are based on 6 sections or more, for anything less than 6 sections prices will be on application.

If you require more than 40 sections please contact our Customer Services team on **01342 302250**.

Primer, RAL Colours and Classic Cast Iron Colours

Height A (mm)	Width B (mm)	Model	Watts Δt 50°C	Btu's Δt 50°C	Primer Ex VAT	Primer Inc VAT	Colours Ex VAT	Colours Inc VAT
DELIVERY TIMES			UP TO 3 WEEKS					
580	71	WENT2C580	70	239	£82.00	£98.40	£93.00	£111.60
750	71	WENT2C750	93	317	£92.00	£110.40	£103.00	£123.60

Please specify your finish at time of order, delivered in up to 3 weeks

Burnished and Industrial Finishes

Height A (mm)	Width B (mm)	Model	Watts Δt 50°C	Btu's Δt 50°C	Burnished Ex VAT	Burnished Inc VAT	Industrial Ex VAT	Industrial Inc VAT
DELIVERY TIMES			UP TO 6 WEEKS		UP TO 6 WEEKS			
580	71	WENT2C580	70	239	£128.00	£153.60	£128.00	£153.60
750	71	WENT2C750	93	317	£138.00	£165.60	£138.00	£165.60

Please specify your finish at time of order, delivered in up to 6 weeks



Burnished finish



Industrial finish

Classic Cast Iron Colours



For samples of our Classic Cast Iron colours please call **01342 302250**.

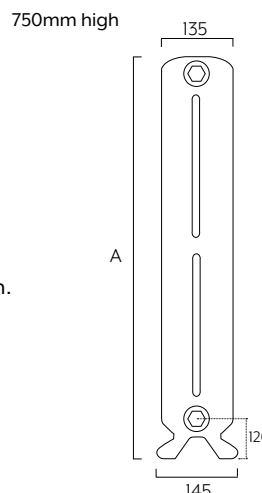
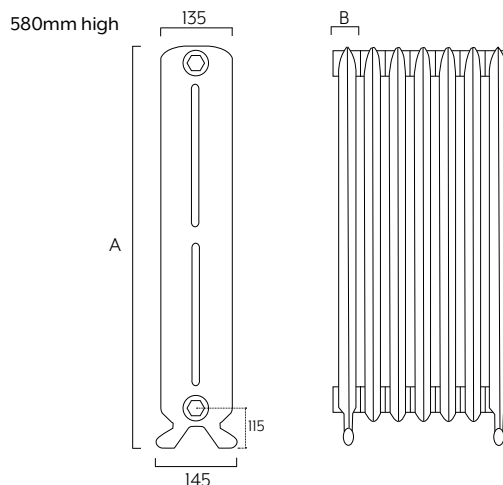

Pipe centres left to right	Footed End section depth	Pipe centres from wall
71 x number of sections + 34mm bushes + valves	145mm (footed ends protrude 10mm total from section depth)	As a free standing radiator, pipe centres depend on final position.

Please note for sections without Footed Ends deduct 70mm from the height of the section.

Any quoted lengths are provided for guidance only. Due to the nature, and production process of these radiators, tolerances are to be expected and we strongly advise to always have the actual product on-site prior to any pipe-work being installed.

*Saving based on the value of individual items when bought separately.
Order any of our selected valves & matching pipe covers at the same time as your radiator.

Stamford shown on page 84

Cast Iron; 2 column Footed Ends only
CE/UKCA approved & certified to BS EN442

188 RAL colours, 4 special finishes, Burnished finish plus
1 Galvanised finish (details below). Please call **01342 302250** for a RAL chart.

Made to order: RAL colours, Soft Gold, Slate Grey, Flat Black up to 5 weeks.
Antique Brass, Burnished, Galvanised Copper up to 7 weeks.
Please add 10 working days for orders of more than 10 radiators.



Vintage TRV & Pipe Covers



SAVE £45*

WHEN YOU BUY OUR VINTAGE TRV & PIPE COVERS WITH ANY CAST IRON PURCHASE. QUOTE **PROMOV2** AT TIME OF ORDER.

For all Vintage TRV finishes see page 122

Stamford Sectional options

Free standing with Footed Ends only

RAL & Special Finishes (White, Soft Gold, Flat Black, Slate Grey)

2 Column

Height A (mm)	Width B (mm)	Model	Watts Δt 50°C	Btu's Δt 50°C	RAL Colours Ex VAT	RAL Colours Inc VAT	Special Finishes Ex VAT	Special Finishes Inc VAT
DELIVERY TIMES					UP TO 5 WEEKS		UP TO 5 WEEKS	
640	80	STAM2C640	73	249	£117.87	£141.44	£117.87	£141.44

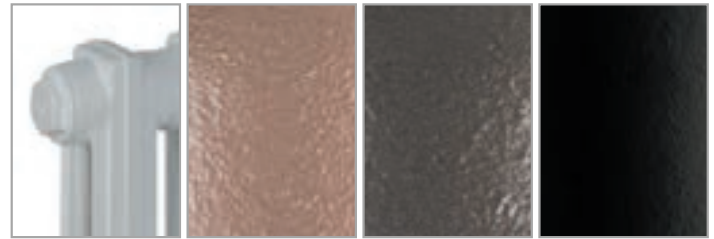

White

Soft Gold

Slate Grey

Flat Black

Please specify your finish at time of order, delivery time is 5 weeks

Burnished Finishes

2 Column

Height A (mm)	Width B (mm)	Model	Watts Δt 50°C	Btu's Δt 50°C	Burnished Ex VAT	Burnished Inc VAT
DELIVERY TIMES					UP TO 7 WEEKS	
640	80	STAM2C640	73	249	£142.71	£171.25



Burnished

Please specify your finish at time of order, delivery time is 7 weeks

Antique Brass & Galvanised Finish Antique Copper

If selecting Antique Brass please read page 191 regarding the below finish.

2 Column

Height A (mm)	Width B (mm)	Model	Watts Δt 50°C	Btu's Δt 50°C	Antique Brass Ex VAT	Antique Brass Inc VAT	Galvanised Copper Ex VAT	Galvanised Copper Inc VAT
DELIVERY TIMES					UP TO 7 WEEKS		UP TO 7 WEEKS	
640	80	STAM2C640	73	249	£142.71	£171.25	£173.96	£208.75



Galvanised Copper



Antique Brass

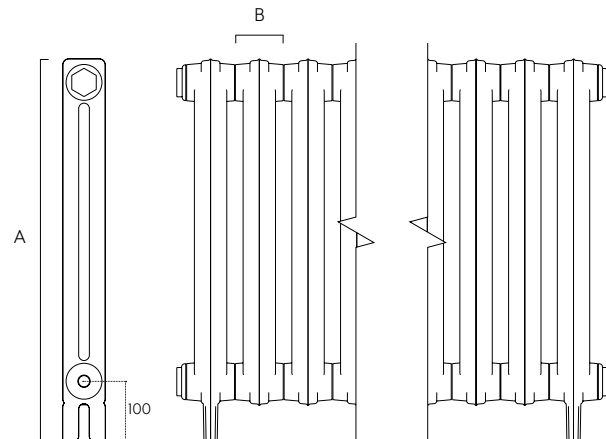

Stamford	Pipe centres left to right	Pipe centres from wall	Depth from wall
2 Column	80mm x sections plus 32mm plus valves	85-105mm	120-150mm

*Saving based on the value of individual items when bought separately. Order any of our selected valves & matching pipe covers at the same time as your radiator.

Athena BDO shown on page 90



Steel; Slimline horizontal towel rail
CE/UKCA approved & certified to BS EN442.

White RAL 9016 as standard, 188 RAL colours
31 Special Finishes (stock sizes only).
Please call **01342 302250** for a RAL or Special Finish chart.
6 NEW Feature Finishes (stock sizes only), call **01342 302250** for colour samples.

Stock White RAL 9016: 48-72 Hours. Special & Feature Finishes: Up to 2 weeks
Made to Order White and RAL Colours: Up to 6 weeks.

Stock options White RAL 9016

Please add 10% to the RAL price to work out your Special or Feature Finish price

Height (mm)	Width (mm)	Model	Watts Δt 50°C	Btu's Δt 50°C	White Ex VAT	White Inc VAT	RAL Colours	
							Ex VAT	Inc VAT
DELIVERY TIMES							48-72 HOURS	UP TO 6 WEEKS
370	1200	ATHEBDO3712	444	1515	£574.00	£688.80	£717.50	£861.00
455	1200	ATHEBDO4512	539	1839	£610.00	£732.00	£762.50	£915.00
	1500	ATHEBDO4515	647	2208	£659.00	£790.80	£823.75	£988.50
540	1200	ATHEBDO5412	617	2105	£645.00	£774.00	£806.25	£967.50
	1500	ATHEBDO5415	736	2511	£700.00	£840.00	£875.00	£1,050.00

Made to order options

Height (mm)	Width (mm)	Model	Watts Δt 50°C	Btu's Δt 50°C	White Ex VAT	White Inc VAT	RAL Colours	
							Ex VAT	Inc VAT
DELIVERY TIMES							UP TO 6 WEEKS	UP TO 6 WEEKS
370	1000	ATHEBDO3710	355	1211	£543.00	£651.60	£678.75	£814.50
	1500	ATHEBDO3715	534	1822	£620.00	£744.00	£775.00	£930.00
455	1000	ATHEBDO4510	431	1471	£576.00	£691.20	£720.00	£864.00
540	1000	ATHEBDO5410	498	1699	£607.00	£728.40	£758.75	£910.50



Cylinder Valve & Pipe Covers



SAVE £45*

WHEN YOU BUY OUR CYLINDER VALVE & PIPE COVERS WITH ANY TOWEL RAIL PURCHASE. QUOTE PROMOV3 AT TIME OF ORDER.

Available in White or Chrome

Pipe centres left to right	Pipe centres from wall	Depth from wall
width - 70mm	45mm to 53mm	67mm to 75mm

67-75
45-53

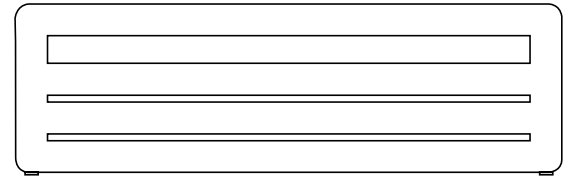

*Saving based on the value of individual items when bought separately. Order any of our selected valves & matching pipe covers at the same time as your radiator; PROMOV3W (white), PROMOV3C (chrome).

Athena Towel Rail shown on page 91



Steel; Slimline towel rail
CE/UKCA approved & certified to BS EN442.

White RAL 9016 as standard, 188 RAL colours
31 Special Finishes (stock sizes only).
Please call **01342 302250** for a RAL or Special Finish chart.
6 NEW Feature Finishes (stock sizes only), call **01342 302250** for colour samples.

Stock White RAL 9016: 48-72 Hours. Special & Feature Finishes: Up to 2 weeks
Made to Order White and RAL Colours: Up to 6 weeks.

Pipe centres left to right	Pipe centres from wall	Depth from wall
width - 70mm	45mm to 53mm	67mm to 75mm

Stock options White RAL 9016

Please add 10% to the RAL price to work out your Special or Feature Finish price

Height (mm)	Width (mm)	Model	Watts Δt 50°C	Btu's Δt 50°C	White Ex VAT	White Inc VAT	RAL Colours	
							Ex VAT	Inc VAT
DELIVERY TIMES							48-72 HOURS	UP TO 6 WEEKS
920	500	ATHETR9250	396	1351	£613.00	£735.60	£766.25	£919.50
1260	500	ATHETRI250	532	1815	£723.00	£867.60	£903.75	£1,084.50

Made to order options

Height (mm)	Width (mm)	Model	Watts Δt 50°C	Btu's Δt 50°C	White Ex VAT	White Inc VAT	RAL Colours	
							Ex VAT	Inc VAT
DELIVERY TIMES							UP TO 6 WEEKS	UP TO 6 WEEKS
1600	500	ATHETRI650	678	2313	£870.00	£1,044.00	£1,087.50	£1,305.00



Cylinder Valve & Pipe Covers



SAVE £45*

WHEN YOU BUY OUR CYLINDER VALVE & PIPE COVERS WITH ANY TOWEL RAIL PURCHASE. QUOTE PROMOV3 AT TIME OF ORDER.

Available in White or Chrome

67-75
45-53

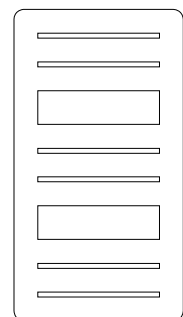

Step BDO shown on page 88

High quality Italian design & manufacture
Aluminium; horizontal towel rail
10 year guarantee, CE/UKCA approved & certified to BS EN442.

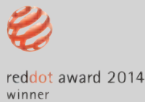

Pearl White & Chrome

Made to Order: Up to 5 weeks

Pipe centres left to right	Pipe centres from wall	Depth from wall
width - 224mm	60mm - 67mm	107mm - 114mm

Cylinder Valve & Pipe Covers



SAVE £45*

WHEN YOU BUY OUR CYLINDER VALVE & PIPE COVERS WITH ANY TOWEL RAIL PURCHASE. QUOTE **PROMOV3** AT TIME OF ORDER.

Available in White or Chrome

Made to order options - Chrome

Height (mm)	Width (mm)	Model	Watts Δt 50°C	Btu's Δt 50°C	Chrome Ex VAT	Chrome Inc VAT
DELIVERY TIMES			UP TO 5 WEEKS			
310	1500	STEBDO3115	326	1112	£1,755.00	£2,106.00
	1800	STEBDO3118	391	1334	£2,038.00	£2,445.60
430	1500	STEBDO4315	436	1488	£2,161.00	£2,593.20
	1800	STEBDO4318	524	1788	£2,794.00	£3,352.80

Made to order options - Pearl White

Height (mm)	Width (mm)	Model	Watts Δt 50°C	Btu's Δt 50°C	Pearl White Ex VAT	Pearl White Inc VAT
DELIVERY TIMES			UP TO 5 WEEKS			
310	1500	STEBDO3115WP	466	1590	£1,465.00	£1,758.00
	1800	STEBDO3118WP	559	1907	£1,496.00	£1,795.20
430	1500	STEBDO4315WP	624	2129	£1,747.00	£2,096.40
	1800	STEBDO4318WP	749	2556	£1,977.00	£2,372.40

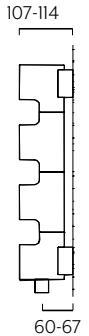

Step shown on page 89

High quality Italian design & manufacture
Aluminium; vertical ladder rail. Hydronic & Electric models
10 year guarantee, CE/UKCA approved & certified to BS EN442.



Pearl White

Made to Order:
Up to 5 weeks: Hydronic & Electric Pearl White

Pipe centres left to right	Pipe centres from wall	Depth from wall
width - 224mm	60mm - 67mm	107mm - 114mm

Cylinder Valve & Pipe Covers



SAVE £45*

WHEN YOU BUY OUR CYLINDER VALVE & PIPE COVERS WITH ANY TOWEL RAIL PURCHASE. QUOTE **PROMOV3** AT TIME OF ORDER.

Available in White or Chrome

Made to order options - Hydronic

Height (mm)	Width (mm)	Model	Watts Δt 50°C	Btu's Δt 50°C	Pearl White Ex VAT	Pearl White Inc VAT
DELIVERY TIMES			UP TO 5 WEEKS			
760	500	STEP7650WP	370	1262	£1,913.00	£2,295.60
	600	STEP7660WP	421	1436	£1,938.00	£2,325.60
1240	500	STEP1250WP	598	2040	£2,631.00	£3,157.20
	600	STEP1260WP	653	2228	£2,653.00	£3,183.60
1720	500	STEP1750WP	816	2784	£3,330.00	£3,996.00
	600	STEP1760WP	935	3190	£3,381.00	£4,057.20

107-114 [360-67

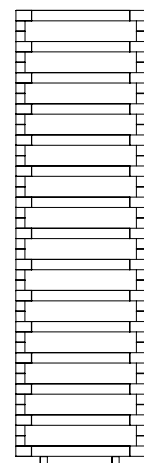
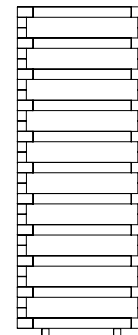
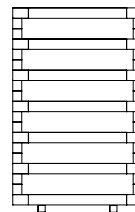

Made to order options - Electric

Height (mm)	Width (mm)	Model	Watts Δt 50°C	Pearl White Ex VAT	Pearl White Inc VAT
DELIVERY TIMES			UP TO 5 WEEKS		
775	500	STEP7750E	250	£2,302.00	£2,762.40
1255	500	STEP1250E	450	£2,977.00	£3,572.40
1735	500	STEP1750E	650	£3,667.00	£4,400.40

The Step Electric has a number of functions that give you complete control. You can set the desired temperature in adjustments from 7°C to 31°C, there is a boost facility that delivers maximum power for 2 hours. It also has infrared capabilities for weekly programming, comfort and night-time modes, via remote control.

*Saving based on the value of individual items when bought separately. Order any of our selected valves & matching pipe covers at the same time as your radiator; **PROMOV3W** (white), **PROMOV3C** (chrome).

Relax Bagno shown on page 92



High quality Italian design & manufacture
Steel; round tube radiator with a steel flat cover, underneath connections only
CE/UKCA approved & certified to BS EN442.

White RAL 9016 as standard, 188 RAL colours & 31 Special Finishes.
Please call **01342 302250** for a RAL or Special Finish chart.
6 NEW Feature Finishes (stock sizes only), see page 7 or call **01342 302250** for samples.

Stock White RAL 9016: 48-72 Hours. Feature Finishes: Up to 2 weeks.
Made to Order White, RALs & Special Finishes: Up to 5 weeks.
Polished Stainless Steel: Up to 8 weeks



Cylinder Valve & Pipe Covers

SAVE £45*
WHEN YOU BUY OUR CYLINDER VALVE & PIPE COVERS WITH ANY TOWEL RAIL PURCHASE. QUOTE PROMOV3 AT TIME OF ORDER.

Available in White or Chrome

Single / Double	Pipe centres left to right	Pipe centres from wall	Depth from wall
Single	width - 109mm	55mm - 65mm	148mm - 158mm
Double	width - 109mm	79mm - 89mm	172mm - 182mm

Stock options White RAL 9016 - Single

Please add 10% to the RAL/Special Finish price to work out your Feature Finish price

Height (mm)	Width (mm)	Model	Watts Δt 50°C	Btu's Δt 50°C	White Ex VAT	White Inc VAT	RALs & Special Finishes	
							Ex VAT	Inc VAT
DELIVERY TIMES					48-72 HOURS		UP TO 5 WEEKS	
1853	517	RELBASV1851	1178	4019	£1,987.00	£2,384.40	£2,483.75	£2,980.50
	653	RELBASV1865	1519	5183	£2,097.00	£2,516.40	£2,621.25	£3,145.50

Stock options White RAL 9016 - Double

Please add 10% to the RAL/Special Finish price to work out your Feature Finish price

Height (mm)	Width (mm)	Model	Watts Δt 50°C	Btu's Δt 50°C	White Ex VAT	White Inc VAT	RALs & Special Finishes	
							Ex VAT	Inc VAT
DELIVERY TIMES					48-72 HOURS		UP TO 5 WEEKS	
1853	517	RELBADV1851	1477	5040	£2,295.00	£2,754.00	£2,868.75	£3,442.50
	653	RELBADV1865	1817	6200	£2,631.00	£3,157.20	£3,288.75	£3,946.50

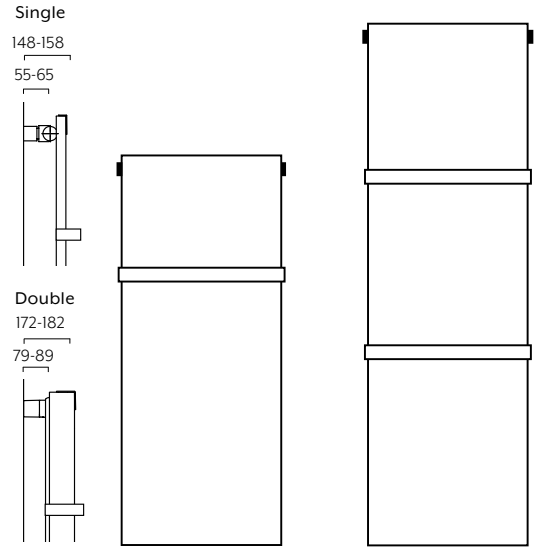

Please note: 1553mm high models have 1 chrome towel bar, 1853mm high models have 2 chrome bars.

Made to order options - Single white & colours

Height (mm)	Width (mm)	Model	Watts Δt 50°C	Btu's Δt 50°C	White Ex VAT	White Inc VAT	RALs & Special Finishes	
							Ex VAT	Inc VAT
DELIVERY TIMES					UP TO 5 WEEKS		UP TO 5 WEEKS	
1553	381	RELBASV1538	699	2385	£1,271.00	£1,525.20	£1,588.75	£1,906.50
	517	RELBASV1551	984	3357	£1,391.00	£1,669.20	£1,738.75	£2,086.50
	653	RELBASV1565	1269	4330	£1,486.00	£1,783.20	£1,857.50	£2,229.00
1853	381	RELBASV1838	837	2856	£1,743.00	£2,091.60	£2,178.75	£2,614.50

Made to order options - Double white & colours

Height (mm)	Width (mm)	Model	Watts Δt 50°C	Btu's Δt 50°C	White Ex VAT	White Inc VAT	RALs & Special Finishes	
							Ex VAT	Inc VAT
DELIVERY TIMES					UP TO 5 WEEKS		UP TO 5 WEEKS	
1553	381	RELBADV1538	1017	3470	£1,568.00	£1,881.60	£1,960.00	£2,352.00
	517	RELBADV1551	1431	4883	£1,679.00	£2,014.80	£2,098.75	£2,518.50
	653	RELBADV1565	1591	5428	£1,785.00	£2,142.00	£2,231.25	£2,677.50
1853	381	RELBADV1838	1050	3583	£2,051.00	£2,461.20	£2,563.75	£3,076.50

Made to order options - Single Polished Stainless Steel

Height (mm)	Width (mm)	Model	Watts Δt 50°C	Btu's Δt 50°C	Polished Stainless Steel	
					Ex VAT	Inc VAT
DELIVERY TIMES					UP TO 8 WEEKS	
1553	381	RELBASV1538	489	1668	£2,811.00	£3,373.20
	517	RELBASV1551	689	2351	£2,968.00	£3,561.60
	653	RELBASV1565	888	3030	£3,079.00	£3,694.80
1853	381	RELBASV1838	586	1999	£3,653.00	£4,383.60
	517	RELBASV1851	825	2815	£3,927.00	£4,712.40
	653	RELBASV1865	1063	3627	£4,146.00	£4,975.20

Made to order options - Double Polished Stainless Steel

Height (mm)	Width (mm)	Model	Watts Δt 50°C	Btu's Δt 50°C	Polished Stainless Steel	
					Ex VAT	Inc VAT
DELIVERY TIMES					UP TO 8 WEEKS	
1553	381	RELBADV1538	712	2429	£3,731.00	£4,477.20
	517	RELBADV1551	1002	3419	£3,847.00	£4,616.40
	653	RELBADV1565	1114	3801	£4,079.00	£4,894.80
1853	381	RELBADV1838	735	2508	£4,710.00	£5,652.00
	517	RELBADV1851	1034	3528	£5,058.00	£6,069.60
	653	RELBADV1865	1272	4340	£5,280.00	£6,336.00

*Saving based on the value of individual items when bought separately. Order any of our selected valves & matching pipe covers at the same time as your radiator; PROMOV3W (white), PROMOV3C (chrome).

Echo shown on page 93



Steel; Side loading towel rail, 50mm x 10mm flat tubes
Can be installed left or right-handed
CE/UKCA approved & certified to BS EN442.

White RAL 9016 as standard, 188 RAL colours
31 Special Finishes (stock sizes only).
6 NEW Feature Finishes (stock sizes only), see page 7 or call **01342 302250** for samples.

Stock White RAL 9016: 48-72 Hours. Special & Feature Finishes: Up to 2 weeks
Made to Order White and RAL Colours: Up to 6 weeks. Electric: Up to 6 weeks.



Stock options White RAL 9016- Hydronic

Please add 10% to the RAL price to work out your Special or Feature Finish price

Height (mm)	Width (mm)	Model	Watts Δt 50°C	Btu's Δt 50°C	White Ex VAT	White Inc VAT	RAL Colours	
							Ex VAT	Inc VAT
DELIVERY TIMES					48-72 HOURS		UP TO 6 WEEKS	
850	500	ECHO8550	585	1996	£521.00	£625.20	£651.25	£781.50
1110	500	ECHO1150	764	2607	£647.00	£776.40	£808.75	£970.50

Made to order options - Hydronic

Height (mm)	Width (mm)	Model	Watts Δt 50°C	Btu's Δt 50°C	White Ex VAT	White Inc VAT	RAL Colours	
							Ex VAT	Inc VAT
DELIVERY TIMES					UP TO 6 WEEKS		UP TO 6 WEEKS	
655	500	ECHO6550	450	1535	£438.00	£525.60	£547.50	£657.00
	600	ECHO6560	506	1726	£456.00	£547.20	£570.00	£684.00
850	600	ECHO8560	655	2235	£544.00	£652.80	£680.00	£816.00
1110	600	ECHO1160	857	2924	£680.00	£816.00	£850.00	£1,020.00
1695	500	ECHO1650	1167	3982	£911.00	£1,093.20	£1,138.75	£1,366.50
	600	ECHO1660	1310	4470	£962.00	£1,154.40	£1,202.50	£1,443.00

*Saving based on the value of individual items when bought separately. Order any of our selected valves & matching pipe covers at the same time as your radiator; PROMOV3W (white), PROMOV3C (chrome).

Cylinder Valve & Pipe Covers



SAVE £45*

WHEN YOU BUY OUR CYLINDER VALVE & PIPE COVERS WITH ANY TOWEL RAIL PURCHASE. QUOTE PROMOV3 AT TIME OF ORDER.

Available in White or Chrome

Made to order options - Electric

Pipe centres left to right
50mm
Pipe centres from wall
57mm - 65mm
Depth from wall
112mm - 120mm

Height (mm)	Width (mm)	Model	Watts Δt 50°C	White Ex VAT	White Inc VAT	RAL Colours	
						Ex VAT	Inc VAT
DELIVERY TIMES					UP TO 6 WEEKS		
850	500	ECHO8550EW	600	£672.00	£806.40		
	600	ECHO8560EW	600	£694.00	£832.80		
1110	500	ECHO1150EW	800	£792.00	£950.40		
	600	ECHO1160EW	800	£822.00	£986.40		
1695	500	ECHO1650EW	1200	£1,045.00	£1,254.00		
	600	ECHO1660EW	1200	£1,091.00	£1,309.20		

Supplied as standard with a MOA Element

- 5 heat settings from 30°C to 60°C regulating internal radiator temperature, denoted by 5 LEDs. No Timer.
- Compatible with external Timer as remembers settings when turned off
- 55mm diameter clock shaped face.
- 4x Buttons: Temperature +/-, Dryer, Power. Frost & overheating protection.
- Straight cable, no plug. IPx5. Class 1. Guarantee - 2 years.

Sitar BDO shown on page 100



High quality Italian design & manufacture
Steel: 23mm cross tubes. CE/UKCA approved & certified to BS EN442.

White RAL 9016 as standard, 188 RAL colours & 31 Special Finishes.
Please call **01342 302250** for a RAL or Special Finish chart.
6 NEW Feature Finishes (stock sizes only), see page 7 or call **01342 302250** for samples..

Stock White RAL 9016: 48-72 Hours. Feature Finishes: Up to 2 weeks.
Made to Order White, RALs & Special Finishes: Up to 5 weeks.

Stock options White RAL 9016

Please add 10% to the RAL/Special Finish price to work out your Feature Finish price

Height (mm)	Width (mm)	Model	Watts Δt 50°C	Btu's Δt 50°C	White Ex VAT	White Inc VAT	RALs & Special Finishes	
							Ex VAT	Inc VAT
DELIVERY TIMES					48-72 HOURS		UP TO 5 WEEKS	
373	1220	SITBDO3712	517	1764	£469.00	£562.80	£586.25	£703.50
	1520	SITBDO3715	647	2208	£564.00	£676.80	£705.00	£846.00
543	1220	SITBDO5412	776	2648	£585.00	£702.00	£731.25	£877.50
	1520	SITBDO5415	967	3299	£654.00	£784.80	£817.50	£981.00

Made to order options

Height (mm)	Width (mm)	Model	Watts Δt 50°C	Btu's Δt 50°C	White Ex VAT	White Inc VAT	RALs & Special Finishes	
							Ex VAT	Inc VAT
DELIVERY TIMES					UP TO 5 WEEKS		UP TO 5 WEEKS	
373	520	SITBDO3752	240	819	£325.00	£390.00	£406.25	£487.50
543	520	SITBDO5452	360	1228	£376.00	£451.20	£470.00	£564.00
985	520	SITBDO9852	646	2204	£515.00	£618.00	£643.75	£772.50
	1220	SITBDO9812	1383	4719	£796.00	£955.20	£995.00	£1,194.00
	1520	SITBDO9815	1716	5855	£878.00	£1,053.60	£1,097.50	£1,317.00

Cylinder Valve & Pipe Covers



SAVE £45*

WHEN YOU BUY OUR CYLINDER VALVE & PIPE COVERS WITH ANY TOWEL RAIL PURCHASE. QUOTE PROMOV3 AT TIME OF ORDER.

Available in White or Chrome

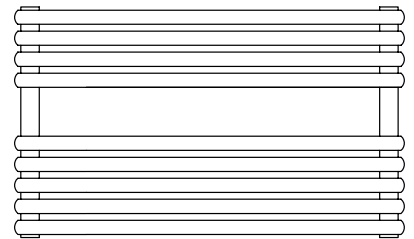
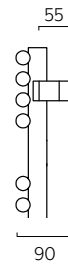

Pipe centres left to right	Pipe centres from wall	Depth from wall
width - 50mm	55mm	90mm

*Saving based on the value of individual items when bought separately. Order any of our selected valves & matching pipe covers at the same time as your radiator; PROMOV3W (white), PROMOV3C (chrome).

Piano Towel Rail shown on page 94 New

High quality Italian design & manufacture
Steel; 50mm x 10mm flat tubes with 30mm collectors in single & double
CE/UKCA approved & certified to BS EN442.



White RAL 9016 as standard, 188 RAL colours & 31 Special Finishes.
Please call **01342 302250** for a RAL or Special Finish chart.

6 NEW Feature Finishes (stock sizes only), see page 7 or call **01342 302250** for samples.

Stock White RAL 9016: 48-72 Hours. Feature Finishes: Up to 2 weeks.
Made to Order White, RALs & Special Finishes: Up to 5 weeks.

Single Stock options White RAL 9016

Please add 10% to the RAL/Special Finish price to work out your Feature Finish price

Height (mm)	Width (mm)	Model	Watts Δt 50°C	Btu's Δt 50°C	White Ex VAT	White Inc VAT	RALs & Special Finishes	RALs & Special Finishes
							Ex VAT	Inc VAT
DELIVERY TIMES							48-72 HOURS	UP TO 5 WEEKS
792	506	PIATRS7950	412	1406	£324.00	£388.80	£405.00	£486.00
	606	PIATRS7960	483	1648	£331.00	£397.20	£413.75	£496.50
1156	506	PIATRS1150	558	1904	£397.00	£476.40	£496.25	£595.50
	606	PIATRS1160	658	2245	£403.00	£483.60	£503.75	£604.50
1520	506	PIATRS1550	718	2450	£452.00	£542.40	£565.00	£678.00
	606	PIATRS1560	848	2893	£465.00	£558.00	£581.25	£697.50

Cylinder Valve & Pipe Covers



SAVE £45*

WHEN YOU BUY OUR CYLINDER VALVE & PIPE COVERS WITH ANY TOWEL RAIL PURCHASE. QUOTE PROMOV3 AT TIME OF ORDER.

Available in White or Chrome

Piano Towel Rail Single	Pipe centres left to right	Pipe centres from wall	Depth from wall
	width - 50mm	55mm	78mm

Single Made to order options

Height (mm)	Width (mm)	Model	Watts Δt 50°C	Btu's Δt 50°C	White Ex VAT	White Inc VAT	RALs & Special Finishes	RALs & Special Finishes
							Ex VAT	Inc VAT
DELIVERY TIMES							UP TO 5 WEEKS	UP TO 5 WEEKS
792	456	PIATRS7945	377	1286	£321.00	£385.20	£401.25	£481.50
	556	PIATRS7955	447	1525	£325.00	£390.00	£406.25	£487.50
	756	PIATRS7975	588	2006	£339.00	£406.80	£423.75	£508.50
1156	456	PIATRS1145	507	1730	£391.00	£469.20	£488.75	£586.50
	556	PIATRS1155	608	2074	£399.00	£478.80	£498.75	£598.50
	756	PIATRS1175	808	2757	£419.00	£502.80	£523.75	£628.50
1520	456	PIATRS1545	654	2231	£447.00	£536.40	£558.75	£670.50
	556	PIATRS1555	783	2672	£458.00	£549.60	£572.50	£687.00
	756	PIATRS1575	1043	3559	£483.00	£579.60	£603.75	£724.50
1744	456	PIATRS1745	766	2614	£490.00	£588.00	£612.50	£735.00
	506	PIATRS1750	839	2863	£496.00	£595.20	£620.00	£744.00
	556	PIATRS1755	912	3112	£502.00	£602.40	£627.50	£753.00
	606	PIATRS1760	986	3364	£505.00	£606.00	£631.25	£757.50
	756	PIATRS1775	1206	4115	£529.00	£634.80	£661.25	£793.50

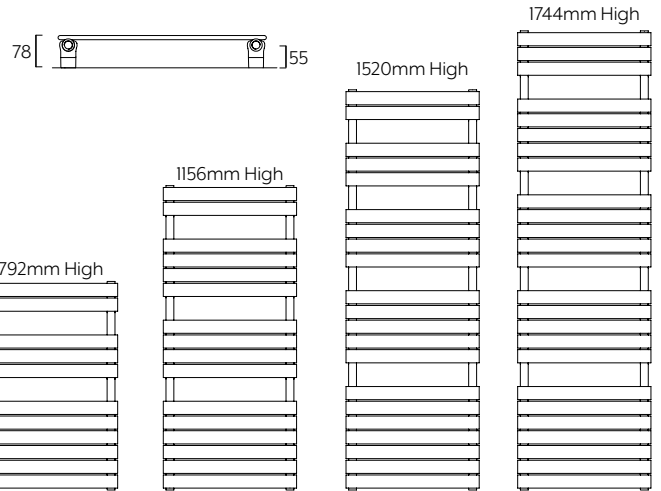

Double Made to order options

Height (mm)	Width (mm)	Model	Watts Δt 50°C	Btu's Δt 50°C	White Ex VAT	White Inc VAT	RALs & Special Finishes	RALs & Special Finishes
							Ex VAT	Inc VAT
DELIVERY TIMES							UP TO 5 WEEKS	UP TO 5 WEEKS
792	456	PIATRD7945	533	1819	£627.00	£752.40	£783.75	£940.50
	506	PIATRD7950	582	1986	£633.00	£759.60	£791.25	£949.50
	556	PIATRD7955	631	2153	£638.00	£765.60	£797.50	£957.00
	606	PIATRD7960	680	2320	£642.00	£770.40	£802.50	£963.00
	756	PIATRD7975	826	2818	£658.00	£789.60	£822.50	£987.00
1156	456	PIATRD1145	725	2474	£764.00	£916.80	£955.00	£1,146.00
	506	PIATRD1150	794	2709	£772.00	£926.40	£965.00	£1,158.00
	556	PIATRD1155	862	2941	£777.00	£932.40	£971.25	£1,165.50
	756	PIATRD1175	1138	3883	£815.00	£978.00	£1,018.75	£1,222.50
1520	456	PIATRD1545	890	3037	£874.00	£1,048.80	£1,092.50	£1,311.00
	556	PIATRD1555	1060	3617	£892.00	£1,070.40	£1,115.00	£1,338.00
	606	PIATRD1560	1145	3907	£901.00	£1,081.20	£1,126.25	£1,351.50
	756	PIATRD1575	1400	4777	£936.00	£1,123.20	£1,170.00	£1,404.00
1744	456	PIATRD1745	991	3381	£950.00	£1,140.00	£1,187.50	£1,425.00
	506	PIATRD1750	1094	3733	£963.00	£1,155.60	£1,203.75	£1,444.50
	556	PIATRD1755	1197	4084	£975.00	£1,170.00	£1,218.75	£1,462.50
	606	PIATRD1760	1300	4436	£988.00	£1,185.60	£1,235.00	£1,482.00
	756	PIATRD1775	1608	5486	£1,026.00	£1,231.20	£1,282.50	£1,539.00

Double Stock options White RAL 9016

Please add 10% to the RAL/Special Finish price to work out your Feature Finish price

Height (mm)	Width (mm)	Model	Watts Δt 50°C	Btu's Δt 50°C	White Ex VAT	White Inc VAT	RALs & Special Finishes	RALs & Special Finishes
							Ex VAT	Inc VAT
DELIVERY TIMES							48-72 HOURS	UP TO 5 WEEKS
1156	606	PIATRD1160	931	3177	£784.00	£940.80	£980.00	£1,176.00
1520	506	PIATRD1550	975	3327	£883.00	£1,059.60	£1,103.75	£1,324.50



Piano Towel Rail Double	Pipe centres left to right	Pipe centres from wall	Depth from wall
	width - 50mm	55mm	78mm

*Saving based on the value of individual items when bought separately. Order any of our selected valves & matching pipe covers at the same time as your radiator; PROMOV3W (white), PROMOV3C (chrome).

Piano Lato shown on page 95 New

High quality Italian design & manufacture.
Steel side loading towel rail, CE/UKCA approved & certified to BS EN442.

White RAL 9016 as standard, 188 RAL colours & 31 Special Finishes.
Please call **01342 302250** for a RAL or Special Finish chart.
6 NEW Feature Finishes, see page 7 or call **01342 302250** for samples.

Stock White RAL 9016: 48-72 Hours. Feature Finishes: Up to 2 weeks.
Made to Order White, RALs & Special Finishes: Up to 5 weeks.



Cylinder Valve & Pipe Covers 

SAVE £45*
WHEN YOU BUY OUR CYLINDER VALVE & PIPE COVERS WITH ANY TOWEL RAIL PURCHASE.
QUOTE PROMOV3 AT TIME OF ORDER.

Pipe centres left to right	Pipe centres from wall	Depth from wall
50mm	57mm - 67mm	80mm - 90mm

Stock options White RAL 9016

Please add 10% to the RAL/Special Finish price to work out your Feature Finish price

Height (mm)	Width (mm)	Model	Watts Δt 50°C	Btu's Δt 50°C	White Ex VAT	White Inc VAT	RALs & Special Finishes Ex VAT	RALs & Special Finishes Inc VAT
DELIVERY TIMES					48-72 HOURS		UP TO 5 WEEKS	
1260	550	PIALATI255	524	1788	£541.00	£649.20	£676.25	£811.50
1596	550	PIALATI555	654	2231	£660.00	£792.00	£825.00	£990.00

*Saving based on the value of individual items when bought separately. Order any of our selected valves & matching pipe covers at the same time as your radiator; PROMOV3W (white), PROMOV3C (chrome).

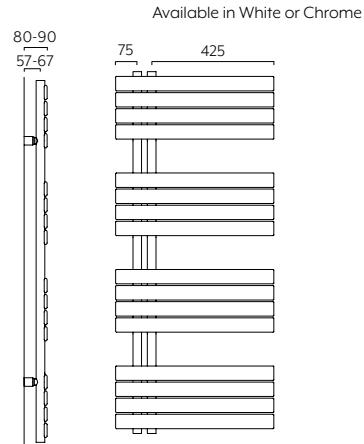

Piano Lato Electric shown on page 95 New

High quality Italian design & manufacture. Fully electric side loading towel rail Eco Design. 10 year guarantee on towel rail. 2 year guarantee on element.



White RAL 9016 as standard, 188 RAL Colours and 31 Special Finishes
Please call **01342 302250** for a RAL or Special Finish chart.

Stock White RAL 9016: 48-72 Hours

Made to Order sizes & colours: Up to 6 weeks.



Please Note: The operation of any Smart Electric Radiator strictly depends on the success of the pairing via the App (and connection will be needed via a WiFi network).

The latest in intelligent smart heating technology is now built into our new Piano Lato electric towel rail. Using the new NOW App it is possible to control and customise your heating straight from your smartphone. Controlling and managing the temperature in your room has never been easier, with their precise sensors, electronic check valve and dedicated app, and fully compatible with Google Home or Amazon Alexa voice assistants.



Stock options White RAL 9016 (Stock White sizes are supplied left-handed)

Height (mm)	Width (mm)	Model	Watts Δt 50°C	White Ex VAT	White Inc VAT	Colours Ex VAT	Colours Inc VAT
DELIVERY TIMES			48-72 HOURS		UP TO 6 WEEKS		
1176	550	PIALATI155E	500	£772.00	£926.40	£849.00	£1,018.80
1540	550	PIALATI555E	750	£897.00	£1,076.40	£987.00	£1,184.40

Made to order options (please specify left or right-handed at time of order)

Height (mm)	Width (mm)	Model	Watts Δt 50°C	White Ex VAT	White Inc VAT	Colours Ex VAT	Colours Inc VAT
DELIVERY TIMES			UP TO 6 WEEKS		UP TO 6 WEEKS		
924	550	PIALAT9255E	400	£721.00	£865.20	£793.00	£951.60
1848	550	PIALAT1855E	1000	£988.00	£1,185.60	£1,087.00	£1,304.40

Made to order Piano Lato Electric models can be left or right-handed, the drawing above shows a left-handed configuration (this is what will be supplied for stock white sizes) the drawing to the right shows a right-handed configuration which is available on a made to order basis. For all made to order models please specify either left or right-handed at time of order, if neither are specified a left-handed model will always be supplied.

Piano Lato Electric stocked (supplied left-handed)

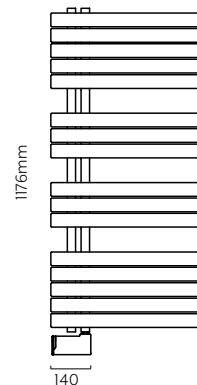

Depth from wall
80mm - 90mm

Piano Lato Electric made to order (right-handed option)

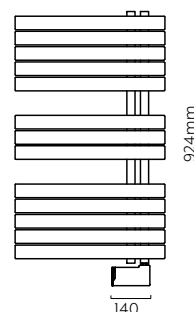

Please note the Italian name shown in the NOW App for this product will be the SoulS

Quadre shown on page 96 New



High quality Italian design & manufacture
Steel; 25mm x 20mm rectangular tubes with 30mm square collectors
CE/UKCA approved & certified to BS EN442.

White RAL 9016 as standard, 188 RAL colours & 31 Special Finishes.

Please call **01342 302250** for a RAL or Special Finish chart.

6 NEW Feature Finishes (stock sizes only), see page 7 or call **01342 302250** for samples.

Stock White RAL 9016: 48-72 Hours. Feature Finishes: Up to 2 weeks.

Made to Order White, RALs & Special Finishes: Up to 5 weeks.



Cylinder Valve & Pipe Covers

SAVE £45*
WHEN YOU BUY OUR CYLINDER VALVE & PIPE COVERS WITH ANY TOWEL RAIL PURCHASE. QUOTE PROMOV3 AT TIME OF ORDER.

Available in White or Chrome

Pipe centres left to right	Pipe centres from wall	Depth from wall
width - 30mm	58mm to 68mm	73mm to 83mm

Stock options White RAL 9016

Please add 10% to the RAL/Special Finish price to work out your Feature Finish price

Height (mm)	Width (mm)	Model	Watts Δt 50°C	Btu's Δt 50°C	White Ex VAT	White Inc VAT	RALs & Special Finishes	RALs & Special Finishes
							Ex VAT	Inc VAT
DELIVERY TIMES					48-72 HOURS		UP TO 5 WEEKS	
1216	430	QUADI243	507	1730	£437.00	£524.40	£546.25	£655.50
	580	QUADI258	667	2276	£464.00	£556.80	£580.00	£696.00

Made to order options - Hydronic

Height (mm)	Width (mm)	Model	Watts Δt 50°C	Btu's Δt 50°C	White Ex VAT	White Inc VAT	RALs & Special Finishes	RALs & Special Finishes
							Ex VAT	Inc VAT
DELIVERY TIMES					UP TO 5 WEEKS		UP TO 5 WEEKS	
872	430	QUAD8743	372	1269	£383.00	£459.60	£478.75	£574.50
	530	QUAD8753	453	1546	£402.00	£482.40	£502.50	£603.00
	580	QUAD8758	493	1682	£425.00	£510.00	£531.25	£637.50
1216	530	QUADI253	613	2092	£456.00	£547.20	£570.00	£684.00
1517	430	QUADI543	652	2225	£471.00	£565.20	£588.75	£706.50
	530	QUADI553	747	2549	£495.00	£594.00	£618.75	£742.50
	580	QUADI558	812	2771	£507.00	£608.40	£633.75	£760.50
1818	430	QUADI843	801	2733	£509.00	£610.80	£636.25	£763.50
	530	QUADI853	912	3112	£534.00	£640.80	£667.50	£801.00
	580	QUADI858	992	3385	£547.00	£656.40	£683.75	£820.50

Feature Finishes (for stock sizes)

Please call customer services for sample swatches.

Copper

Textured Anthracite

Pearl Bronze

Vintage Green

Aged Brass

Satin Gold

To work out your Feature Finish price please add 10% to the RAL/Special Finish colour price shown in the pricing tables.

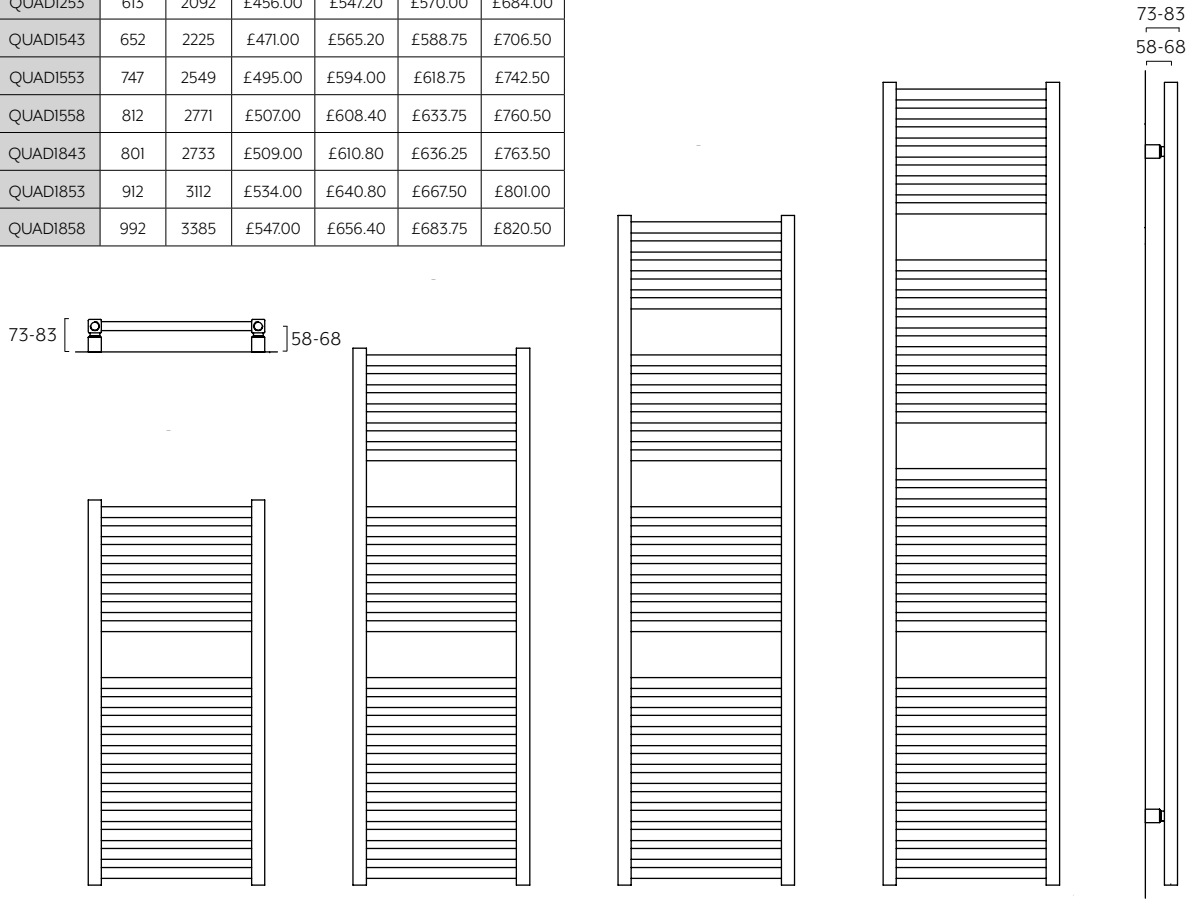

*Saving based on the value of individual items when bought separately. Order any of our selected valves & matching pipe covers at the same time as your radiator; PROMOV3W (white), PROMOV3C (chrome).

Pulsar shown on page 97

High quality Italian design & manufacture.
Steel; frame style, elliptical cross tubes
CE/UKCA approved & certified to BS EN442.

White RAL 9016 as standard, 188 RAL colours & 31 Special Finishes.
Please call **01342 302250** for a RAL or Special Finish chart.

Stock White RAL 9016: 48-72 Hours.

Made to Order sizes & colours: Up to 5 weeks.



Pipe centres left to right	Pipe centres from wall	Depth from wall
width - 44mm	71mm - 86mm	92mm - 107mm

Stock options White RAL 9016

Height (mm)	Width (mm)	Model	Watts Δt 50°C	Btu's Δt 50°C	White Ex VAT	White Inc VAT	RALs & Special Finishes	RALs & Special Finishes
							Ex VAT	Inc VAT
DELIVERY TIMES							48-72 HOURS	UP TO 5 WEEKS
1224	500	PULSI250	604	2061	£487.00	£584.40	£608.75	£730.50
	600	PULSI260	710	2423	£504.00	£604.80	£630.00	£756.00

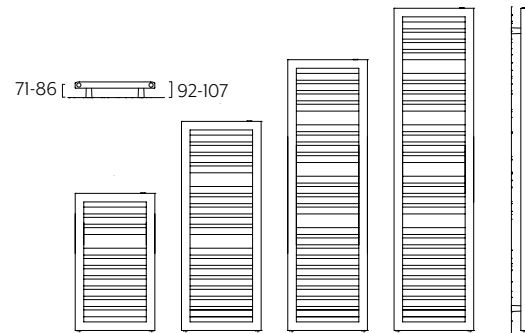

Cylinder Valve & Pipe Covers



SAVE £45*

WHEN YOU BUY OUR CYLINDER VALVE & PIPE COVERS WITH ANY TOWEL RAIL PURCHASE. QUOTE PROMOV3 AT TIME OF ORDER.

Available in White or Chrome

Made to order options - White & colours

Height (mm)	Width (mm)	Model	Watts Δt 50°C	Btu's Δt 50°C	White Ex VAT	White Inc VAT	RALs & Special Finishes	RALs & Special Finishes
							Ex VAT	Inc VAT
DELIVERY TIMES							UP TO 5 WEEKS	UP TO 5 WEEKS
804	450	PULS8045	374	1276	£393.00	£471.60	£491.25	£589.50
	500	PULS8050	409	1396	£399.00	£478.80	£498.75	£598.50
	600	PULS8060	479	1634	£411.00	£493.20	£513.75	£616.50
1224	450	PULSI245	551	1880	£479.00	£574.80	£598.75	£718.50
	500	PULSI245	551	1880	£479.00	£574.80	£598.75	£718.50
1584	450	PULSI545	684	2334	£589.00	£706.80	£736.25	£883.50
	500	PULSI550	753	2569	£616.00	£739.20	£770.00	£924.00
	600	PULSI560	892	3044	£631.00	£757.20	£788.75	£946.50
1884	450	PULSI845	825	2815	£693.00	£831.60	£866.25	£1,039.50
	500	PULSI850	903	3081	£719.00	£862.80	£898.75	£1,078.50
	600	PULSI860	1058	3610	£744.00	£892.80	£930.00	£1,116.00

*Saving based on the value of individual items when bought separately. Order any of our selected valves & matching pipe covers at the same time as your radiator; PROMOV3W (white), PROMOV3C (chrome).

Blues shown on page 110

Stainless Steel; 15mm x 30mm horizontal tubes with 30mm x 30mm collectors
Suitable for a direct system
CE/UKCA approved & certified to BS EN442.

Polished or Satin Stainless Steel

Stock Polished Stainless Steel: 48-72 Hours

Made to Order Satin Stainless Steel: Up to 4 weeks



Pipe centres left to right	Pipe centres from wall	Depth from wall
50mm	55mm to 70mm	85mm to 100mm

Stock options Polished Stainless Steel

Height (mm)	Width (mm)	Model	Watts Δt 50°C	Btu's Δt 50°C	Polished Stainless Steel		
					Ex VAT	Inc VAT	
DELIVERY TIMES							48-72 HOURS
770	500	BLUE7750	236	805	£1,920.00	£2,304.00	
1190	500	BLUE1150	337	1150	£2,700.00	£3,240.00	
1400	500	BLUE1450	379	1293	£3,331.00	£3,997.20	

Made to order options - Satin Stainless Steel

Height (mm)	Width (mm)	Model	Watts Δt 50°C	Btu's Δt 50°C	Satin Stainless Steel		
					Ex VAT	Inc VAT	
DELIVERY TIMES							UP TO 4 WEEKS
770	500	BLUE7750	236	805	£1,379.00	£1,654.80	
1190	500	BLUE1150	337	1150	£1,940.00	£2,328.00	
1400	500	BLUE1450	379	1293	£2,260.00	£2,712.00	

Cylinder Valve & Pipe Covers



SAVE £45*

WHEN YOU BUY OUR CYLINDER VALVE & PIPE COVERS WITH ANY TOWEL RAIL PURCHASE. QUOTE PROMOV3 AT TIME OF ORDER.

Available in White or Chrome

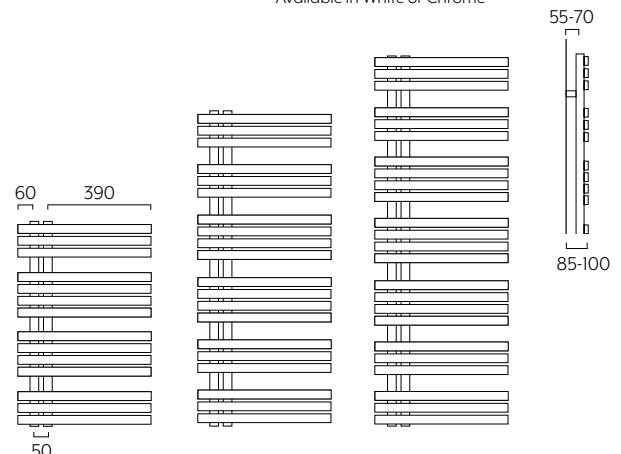

Ellipsis Towel Rail shown on page 99



High quality Italian design & manufacture

Steel; elliptical tube on tube towel rail. CE/UKCA approved & certified to BS EN442.

White RAL 9016 as standard, 188 RAL colours & 31 Special Finishes.

Please call **01342 302250** for a RAL or Special Finish chart.

6 NEW Feature Finishes (stock sizes only), see page 7 or call **01342 302250** for samples.

Stock White RAL 9016: 48-72 Hours. Feature Finishes: Up to 2 weeks.

Made to Order White, RALs & Special Finishes: Up to 5 weeks.



Stock options White RAL 9016

Please add 10% to the RAL/Special Finish price to work out your Feature Finish price

Height (mm)	Width (mm)	Model	Watts Δt 50°C	Btu's Δt 50°C	White Ex VAT	White Inc VAT	RALs & Special Finishes	
							Ex VAT	Inc VAT
DELIVERY TIMES					48-72 HOURS		UP TO 5 WEEKS	
960	500	ELLITR9650	453	1546	£367.00	£440.40	£458.75	£550.50
1200	400	ELLITR1240	457	1559	£438.00	£525.60	£547.50	£657.00
	500	ELLITR1250	549	1873	£445.00	£534.00	£556.25	£667.50
	600	ELLITR1260	641	2187	£473.00	£567.60	£591.25	£709.50
1380	400	ELLITR1340	528	1802	£513.00	£615.60	£641.25	£769.50
	500	ELLITR1350	638	2177	£524.00	£628.80	£655.00	£786.00
	600	ELLITR1360	748	2552	£550.00	£660.00	£687.50	£825.00
1620	500	ELLITR1650	729	2487	£600.00	£720.00	£750.00	£900.00

Made to order options

Height (mm)	Width (mm)	Model	Watts Δt 50°C	Btu's Δt 50°C	White Ex VAT	White Inc VAT	RALs & Special Finishes	
							Ex VAT	Inc VAT
DELIVERY TIMES					UP TO 5 WEEKS		UP TO 5 WEEKS	
960	400	ELLITR9640	371	1266	£361.00	£433.20	£451.25	£541.50
	600	ELLITR9660	534	1822	£389.00	£466.80	£486.25	£583.50
1620	400	ELLITR1640	606	2068	£589.00	£706.80	£736.25	£883.50
	600	ELLITR1660	853	2910	£631.00	£757.20	£788.75	£946.50

Cylinder Valve & Pipe Covers



SAVE £45*

WHEN YOU BUY OUR CYLINDER VALVE & PIPE COVERS WITH ANY TOWEL RAIL PURCHASE. QUOTE PROMOV3 AT TIME OF ORDER.

Available in White or Chrome

Pipe centres left to right	Pipe centres from wall	Depth from wall
width - 50mm	55mm	93mm

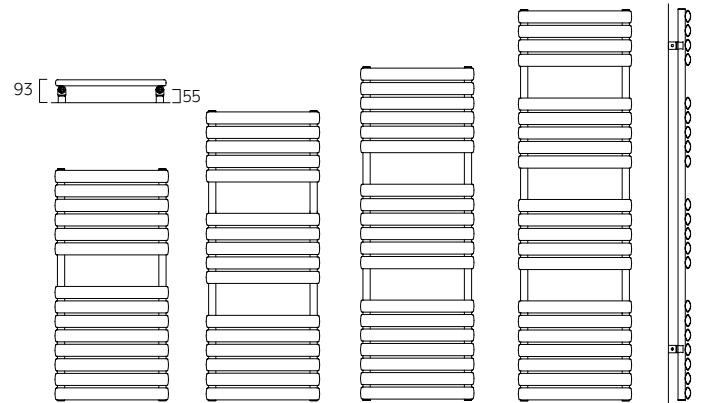

Ellipsis Classic shown on page 98



High quality Italian design & manufacture.

Steel; elliptical tube in tube towel rail. CE/UKCA approved & certified to BS EN442.

White RAL 9016 as standard, 188 RAL colours & 31 Special Finishes.

Please call **01342 302250** for a RAL or Special Finish chart.

6 NEW Feature Finishes, see page 7 or call **01342 302250** for samples.

Stock White RAL 9016: 48-72 Hours. Feature Finishes: Up to 2 weeks.

Made to Order RALs & Special Finishes: Up to 5 weeks.



Cylinder Valve & Pipe Covers



SAVE £45*

WHEN YOU BUY OUR CYLINDER VALVE & PIPE COVERS WITH ANY TOWEL RAIL PURCHASE. QUOTE PROMOV3 AT TIME OF ORDER.

Available in White or Chrome

Pipe centres left to right	Pipe centres from wall	Depth from wall
width - 30mm	55mm - 65mm	72mm - 82mm

Stock options White RAL 9016

Please add 10% to the RAL/Special Finish price to work out your Feature Finish price

Height (mm)	Width (mm)	Model	Watts Δt 50°C	Btu's Δt 50°C	White Ex VAT	White Inc VAT	RALs & Special Finishes	
							Ex VAT	Inc VAT
DELIVERY TIMES					48-72 HOURS		UP TO 5 WEEKS	
780	500	ELLCTR7850	345	1177	£325.00	£390.00	£406.25	£487.50
	600	ELLCTR7860	404	1378	£390.00	£468.00	£487.50	£585.00
1060	500	ELLCTR1050	463	1580	£418.00	£501.60	£522.50	£627.00
	600	ELLCTR1060	546	1863	£485.00	£582.00	£606.25	£727.50
1340	500	ELLCTR1350	581	1982	£519.00	£622.80	£648.75	£778.50
	600	ELLCTR1360	680	2320	£578.00	£693.60	£722.50	£867.00

72-82 [] 55-65

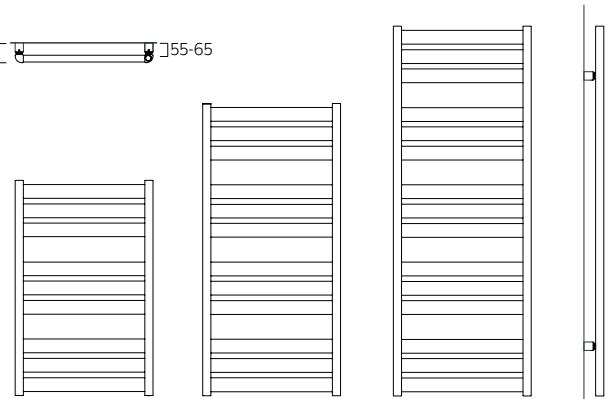

*Saving based on the value of individual items when bought separately. Order any of our selected valves & matching pipe covers at the same time as your radiator; PROMOV3W (white), PROMOV3C (chrome).

Sitar Lato shown on page 101



High quality Italian design & manufacture.
Steel: 23mm cross tubes, CE/UKCA approved & certified to BS EN442.

White RAL 9016 as standard, 188 RAL colours & 31 Special Finishes.
Please call **01342 302250** for a RAL or Special Finish chart.

6 NEW Feature Finishes (stock sizes only), see page 7 or call **01342 302250** for samples.

Stock White RAL 9016: 48-72 Hours. Feature Finishes in up to 2 weeks.
Made to Order White, RALs & Special Finishes: Up to 5 weeks.

Stock options White RAL 9016

Please add 10% to the RAL/Special Finish price to work out your Feature Finish price

Height (mm)	Width (mm)	Model	Watts Δt 50°C	Btu's Δt 50°C	White Ex VAT	White Inc VAT	RALs & Special Finishes Ex VAT		RALs & Special Finishes Inc VAT	
							48-72 HOURS	UP TO 5 WEEKS	48-72 HOURS	UP TO 5 WEEKS
832	500	SITLAT8350	394	1344	£354.00	£424.80	£442.50	£531.00		
	600	SITLAT8360	455	1552	£365.00	£438.00	£456.25	£547.50		
1348	500	SITLAT1350	612	2088	£433.00	£519.60	£541.25	£649.50		
	600	SITLAT1360	708	2416	£447.00	£536.40	£558.75	£670.50		

Made to order options

Height (mm)	Width (mm)	Model	Watts Δt 50°C	Btu's Δt 50°C	White Ex VAT	White Inc VAT	RALs & Special Finishes Ex VAT		RALs & Special Finishes Inc VAT	
							UP TO 5 WEEKS	UP TO 5 WEEKS	UP TO 5 WEEKS	UP TO 5 WEEKS
832	700	SITLAT8370	515	1757	£386.00	£463.20	£482.50	£579.00		
1348	700	SITLAT1370	801	2733	£475.00	£570.00	£593.75	£712.50		
1778	500	SITLAT1750	799	2726	£518.00	£621.60	£647.50	£777.00		
	600	SITLAT1760	924	3153	£540.00	£648.00	£675.00	£810.00		
	700	SITLAT1770	1044	3562	£571.00	£685.20	£713.75	£856.50		



Cylinder Valve & Pipe Covers



SAVE £45*

WHEN YOU BUY OUR CYLINDER VALVE & PIPE COVERS WITH ANY TOWEL RAIL PURCHASE. QUOTE **PROMOV3** AT TIME OF ORDER.

Available in White or Chrome

Pipe centres left to right
50mm
Pipe centres from wall
57mm - 67mm
Depth from wall
92mm - 102mm

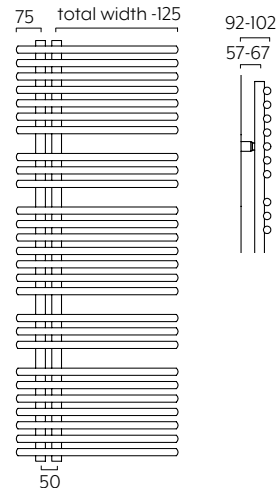

Sitar Lato Electric shown on page 101



High quality Italian design & manufacture. Fully electric side loading towel rail Eco Design. 10 year guarantee on towel rail. 2 year guarantee on element.



White RAL 9016 as standard, 188 RAL Colours and 31 Special Finishes
Please call **01342 302250** for a RAL or Special Finish chart.

Stock White RAL 9016: 48-72 Hours

Made to Order sizes & colours: Up to 6 weeks.

Please Note: The operation of any Smart Electric Radiator strictly depends on the success of the pairing via the App (and connection will be needed via a WiFi network).

The latest in intelligent smart heating technology is now built into our new Sitar Lato electric towel rail. Using the new NOW App it is possible to control and customise your heating straight from your smartphone. Controlling and managing the temperature in your room has never been easier, with their precise sensors, electronic check valve and dedicated app, and fully compatible with Google Home or Amazon Alexa voice assistants.



Stock options White RAL 9016 (Stock White sizes are supplied left-handed)

Height (mm)	Width (mm)	Model	Watts Δt 50°C	White Ex VAT	White Inc VAT	Colours Ex VAT		Colours Inc VAT	
						48-72 HOURS	UP TO 6 WEEKS	48-72 HOURS	UP TO 6 WEEKS
1170	500	SITLAT1150E	500	£855.00	£1,026.00	£941.00	£1,129.20		
1455	600	SITLAT1460E	750	£1,048.00	£1,257.60	£1,153.00	£1,383.60		

Made to order options (please specify left or right-handed at time of order)

Height (mm)	Width (mm)	Model	Watts Δt 50°C	White Ex VAT	White Inc VAT	Colours Ex VAT		Colours Inc VAT	
						UP TO 6 WEEKS	UP TO 6 WEEKS	UP TO 6 WEEKS	UP TO 6 WEEKS
928	500	SITLAT9250E	400	£790.00	£948.00	£869.00	£1,042.80		
1842	600	SITLAT1860E	1000	£1,264.00	£1,516.80	£1,390.00	£1,668.00		

Made to order Sitar Lato Electric models can be left or right-handed, the drawing above shows a left-handed configuration (this is what will be supplied for stock white sizes) the drawing to the right shows a right-handed configuration which is available on a made to order basis. For all made to order models please specify either left or right-handed at time of order, if neither are specified a left-handed model will always be supplied.

Please note the Italian name shown in the NOW App for this product will be the Funky_S

Sitar Lato Electric stocked (supplied left-handed)

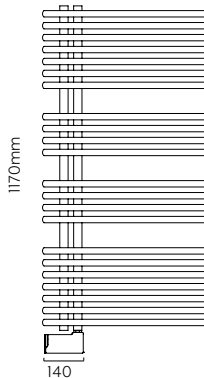

Depth from wall

92mm - 102mm

Sitar Lato Electric made to order (right-handed option)

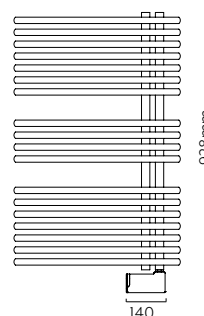

Sitar Towel Rail shown on page 100



High quality Italian design & manufacture.

Steel: 23mm cross tubes, ladder style towel rail in single or double
CE/UKCA approved & certified to BS EN442.



White RAL 9016 as standard, 188 RAL colours & 31 Special Finishes.

Please call **01342 302250** for a RAL or Special Finish chart.

6 NEW Feature Finishes (stock sizes only), see page 7 or call **01342 302250** for samples.

Stock White RAL 9016: 48-72 Hours. Feature Finishes in up to 2 weeks.

Made to Order White, RALs & Special Finishes: Up to 5 weeks.



Cylinder Valve & Pipe Covers



SAVE £45*

WHEN YOU BUY OUR CYLINDER VALVE & PIPE COVERS WITH ANY TOWEL RAIL PURCHASE. QUOTE PROMOV3 AT TIME OF ORDER.

Available in White or Chrome

Single - Stock options White RAL 9016

Please add 10% to the RAL/Special Finish price to work out your Feature Finish price

Height (mm)	Width (mm)	Model	Watts Δt 50°C	Btu's Δt 50°C	White Ex VAT	White Inc VAT	RALs & Special Finishes	
							Ex VAT	Inc VAT
DELIVERY TIMES							48-72 HOURS	UP TO 5 WEEKS
1112	600	SITATRS1160	625	2133	£231.00	£277.20	£288.75	£346.50
1456	500	SITATRS1450	696	2375	£253.00	£303.60	£316.25	£379.50

Single - Made to order options

Height (mm)	Width (mm)	Model	Watts Δt 50°C	Btu's Δt 50°C	White Ex VAT	White Inc VAT	RALs & Special Finishes	
							Ex VAT	Inc VAT
DELIVERY TIMES							UP TO 5 WEEKS	UP TO 5 WEEKS
725	500	SITATRS7250	356	1215	£224.00	£268.80	£280.00	£336.00
	600	SITATRS7260	419	1430	£226.00	£271.20	£282.50	£339.00
	750	SITATRS7275	514	1754	£228.00	£273.60	£285.00	£342.00
1112	500	SITATRS1150	533	1819	£228.00	£273.60	£285.00	£342.00
	750	SITATRS1175	763	2603	£234.00	£280.80	£292.50	£351.00
1456	600	SITATRS1460	812	2771	£258.00	£309.60	£322.50	£387.00
	750	SITATRS1475	986	3364	£277.00	£332.40	£346.25	£415.50
1757	500	SITATRS1750	845	2883	£273.00	£327.60	£341.25	£409.50
	600	SITATRS1760	980	3344	£289.00	£346.80	£361.25	£433.50
	750	SITATRS1775	1182	4033	£342.00	£410.40	£427.50	£513.00

Double - Stock options White RAL 9016

Please add 10% to the RAL/Special Finish price to work out your Feature Finish price

Height (mm)	Width (mm)	Model	Watts Δt 50°C	Btu's Δt 50°C	White Ex VAT	White Inc VAT	RALs & Special Finishes	
							Ex VAT	Inc VAT
DELIVERY TIMES							48-72 HOURS	UP TO 5 WEEKS
1112	600	SITATRD1160	912	3112	£278.00	£333.60	£347.50	£417.00
1456	500	SITATRD1450	1016	3467	£300.00	£360.00	£375.00	£450.00

Double - Made to order options

Height (mm)	Width (mm)	Model	Watts Δt 50°C	Btu's Δt 50°C	White Ex VAT	White Inc VAT	RALs & Special Finishes	
							Ex VAT	Inc VAT
DELIVERY TIMES							UP TO 5 WEEKS	UP TO 5 WEEKS
725	500	SITATRD7250	519	1771	£229.00	£274.80	£286.25	£343.50
	600	SITATRD7260	611	2085	£261.00	£313.20	£326.25	£391.50
1112	500	SITATRD1150	778	2655	£237.00	£284.40	£296.25	£355.50
	750	SITATRD1175	1113	3798	£336.00	£403.20	£420.00	£504.00
1456	600	SITATRD1460	1185	4043	£352.00	£422.40	£440.00	£528.00
	750	SITATRD1475	1430	4879	£437.00	£524.40	£546.25	£655.50
1757	500	SITATRD1750	1233	4207	£372.00	£446.40	£465.00	£558.00
	600	SITATRD1760	1430	4879	£437.00	£524.40	£546.25	£655.50
	750	SITATRD1775	1725	5886	£534.00	£640.80	£667.50	£801.00

Pipe centres left to right	Pipe centres from wall	Depth from wall
width - 40mm	55mm	90mm

Pipe centres left to right	Pipe centres from wall	Depth from wall
width - 40mm	80mm - 90mm	115mm - 125mm

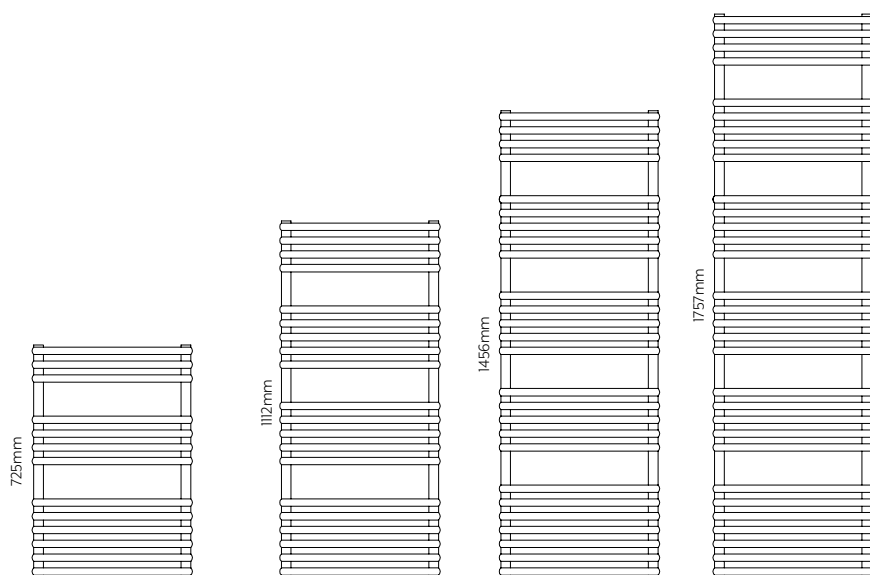
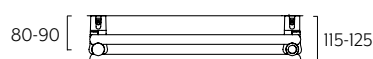
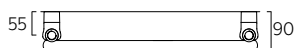

Feature Finishes (for stock sizes)

Please see page 7 for more details or call customer services for sample swatches.



To work out your Feature Finish price please add 10% to the RAL/Special Finish colour price shown in the pricing tables.

*Saving based on the value of individual items when bought separately. Order any of our selected valves & matching pipe covers at the same time as your radiator; PROMOV3W (white), PROMOV3C (chrome).

Poll BDO shown on page 102 New Colours



Steel; 30mm square collectors, 22mm round cross tubes
CE/UKCA approved & certified to BS EN442.

White RAL 9016 as standard, 188 RAL colours
31 Special Finishes (stock sizes only). Please call **01342 302250** for a RAL or Special Finish chart.
6 NEW Feature Finishes (stock sizes only), see page 7 or call **01342 302250** for samples.

Stock White RAL 9016: 48-72 Hours. Special & Feature Finishes: Up to 2 weeks
Made to Order White and RAL Colours: Up to 6 weeks.



Cylinder Valve & Pipe Covers

SAVE £45*
WHEN YOU BUY OUR CYLINDER VALVE & PIPE COVERS WITH ANY TOWEL RAIL PURCHASE. QUOTE PROMOV3 AT TIME OF ORDER.

Available in White or Chrome

Pipe centres left to right	Pipe centres from wall	Depth from wall
width - 30mm	57mm to 65mm	132mm to 140mm

Stock options White RAL 9016

Please add 10% to the RAL price to work out your Special or Feature Finish price

Height (mm)	Width (mm)	Model	Watts Δt 50°C	Btu's Δt 50°C	White Ex VAT	White Inc VAT	RAL Colours	RAL Colours
							Ex VAT	Inc VAT
DELIVERY TIMES					48-72 HOURS		UP TO 6 WEEKS	
460	1200	POLBDO4612	574	1958	£271.00	£325.20	£338.75	£406.50
540	1200	POLBDO5412	691	2358	£313.00	£375.60	£391.25	£469.50

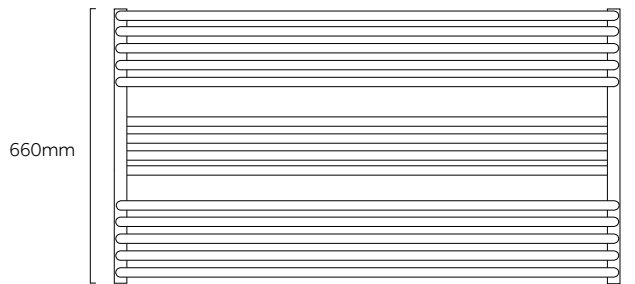
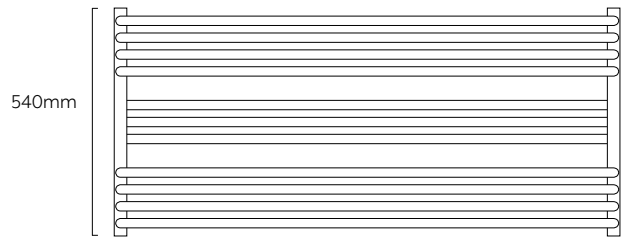
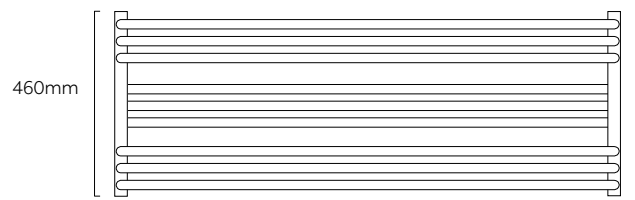
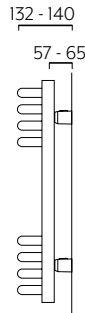

Made to order options - White & colours

Height (mm)	Width (mm)	Model	Watts Δt 50°C	Btu's Δt 50°C	White Ex VAT	White Inc VAT	RAL Colours	RAL Colours
							Ex VAT	Inc VAT
DELIVERY TIMES					UP TO 6 WEEKS		UP TO 6 WEEKS	
460	1000	POLBDO4610	478	1631	£257.00	£308.40	£321.25	£385.50
	1400	POLBDO4614	670	2286	£290.00	£348.00	£362.50	£435.00
540	1000	POLBDO5410	576	1965	£299.00	£358.80	£373.75	£448.50
	1400	POLBDO5414	806	2750	£337.00	£404.40	£421.25	£505.50
660	1000	POLBDO6610	724	2470	£355.00	£426.00	£443.75	£532.50
	1200	POLBDO6612	869	2965	£379.00	£454.80	£473.75	£568.50
	1400	POLBDO6614	1014	3460	£398.00	£477.60	£497.50	£597.00

Feature Finishes

See page 7 for more information or call customer services for sample swatches.

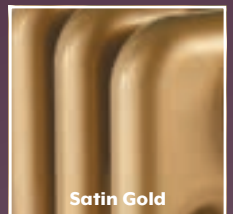
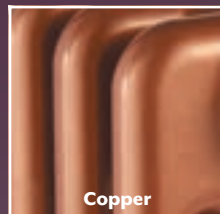
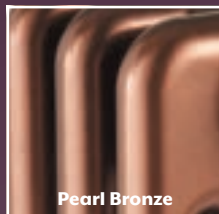
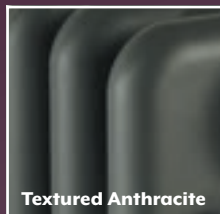
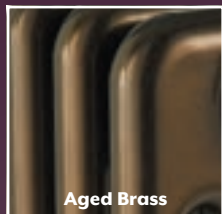

To work out your Special / Feature Finish price please add 10% to the RAL colour price shown in the above tables.

*Saving based on the value of individual items when bought separately. Order any of our selected valves & matching pipe covers at the same time as your radiator; PROMOV3W (white), PROMOV3C (chrome).

Poll shown on page 103

Steel; 30mm square collectors, 22mm round cross tubes
Hydronic & Electric models. CE/UKCA approved & certified to BS EN442.

White RAL 9016 as standard, 188 RAL colours.

31 Special Finishes (stock sizes only). Call **01342 302250** for a RAL or Special Finish chart.

6 NEW Feature Finishes (stock sizes only), see page 7 or call **01342 302250** for samples.

Stock White RAL 9016: 48-72 Hours. Special & Feature Finishes: Up to 2 weeks
Made to Order Colours & Electric models: Up to 6 weeks.



Cylinder Valve & Pipe Covers



SAVE £45*

WHEN YOU BUY OUR CYLINDER VALVE & PIPE COVERS WITH ANY TOWEL RAIL PURCHASE. QUOTE **PROMOV3** AT TIME OF ORDER.

Available in White or Chrome

Pipe centres left to right	Pipe centres from wall
width - 30mm	57mm to 65mm

Stock options White RAL 9016

Please add 10% to the RAL price to work out your Special or Feature Finish price

Height (mm)	Width (mm)	Model	Watts Δt 50°C	Btu's Δt 50°C	White Ex VAT	White Inc VAT	RAL Colours	
							Ex VAT	Inc VAT
DELIVERY TIMES					48-72 HOURS		UP TO 6 WEEKS	
530	450	POLL5345	270	921	£235.00	£282.00	£293.75	£352.50
	500	POLL5350	300	1024	£242.00	£290.40	£302.50	£363.00
	600	POLL5360	360	1228	£252.00	£302.40	£315.00	£378.00
	700	POLL5370	410	1399	£257.00	£308.40	£321.25	£385.50
1055	450	POLL1045	540	1842	£299.00	£358.80	£373.75	£448.50
	500	POLL1050	604	2061	£309.00	£370.80	£386.25	£463.50
	600	POLL1060	720	2457	£328.00	£393.60	£410.00	£492.00
	700	POLL1070	850	2900	£342.00	£410.40	£427.50	£513.00
1480	500	POLL1450	857	2924	£422.00	£506.40	£527.50	£633.00
	600	POLL1460	1030	3514	£432.00	£518.40	£540.00	£648.00
	700	POLL1470	1200	4094	£450.00	£540.00	£562.50	£675.00
	800	POLL1480	1370	4674	£464.00	£556.80	£580.00	£696.00

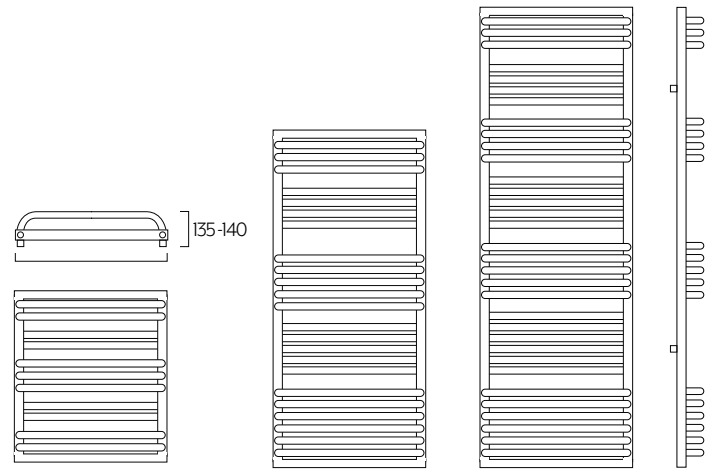

*Saving based on the value of individual items when bought separately. Order any of our selected valves & matching pipe covers at the same time as your radiator; PROMOV3W (white), PROMOV3C (chrome).

Made to order options - White Electric

Height (mm)	Width (mm)	Model	Watts Δt 50°C	White Ex VAT	White Inc VAT
780	500	POLL7850EW	400	£321.00	£385.20
	600	POLL7860EW	400	£341.00	£409.20
1180	500	POLL1150EW	600	£406.00	£487.20
	600	POLL1160EW	800	£435.00	£522.00
1580	500	POLL1550EW	800	£477.00	£572.40
	600	POLL1560EW	1000	£536.00	£643.20

Poll Electric models supplied with a MOA Element:

- 5 heat settings from 30°C to 60°C to regulate the internal radiator temperature. Selected setting denoted by 5 LEDs.
- No Timer.
- Compatible with external Timer as remembers settings when turned off
- 55mm diameter clock shaped face.
- 4x Buttons: Temperature +/-, Dryer, Power.
- Frost & overheating protection.
- Straight cable, no plug. IPx5. Class 1.
- Guarantee - 2 years.

Poppy Towel Rail shown on pages 104-105



High quality Italian design & manufacture
Steel; 25mm curved cross tubes with 40mm 'D' shaped collectors
CE/UKCA approved & certified to BS EN442.



White RAL 9016 as standard, 23 RAL colours, 31 Special Finishes & Chrome.
Please call **01342 302250** for a RAL or Special Finish chart.
6 Feature Finishes, see page 7 or call **01342 302250** for samples.

Stock White RAL 9016 & Chrome: 48-72 Hours

Made to Order RAL, Special & Feature Finishes: Up to 2 weeks
Up to 6 weeks for White electric, 8 weeks for Chrome electric.

Pipe centres left to right	Pipe centres from wall	Depth from wall
width - 44mm	398mm wide = 70mm-80mm 498mm wide = 68mm-78mm 598mm wide = 68mm-78mm	398mm wide = 95mm-105mm 498mm wide = 100mm-110mm 598mm wide = 105mm-115mm

Cylinder Valve & Pipe Covers

SAVE £45*
WHEN YOU BUY OUR CYLINDER VALVE & PIPE COVERS WITH ANY TOWEL RAIL PURCHASE. QUOTE PROMOV3 AT TIME OF ORDER.

Available in White or Chrome

Stock options White RAL 9016

Height (mm)	Width (mm)	Model	Watts Δt 50°C	Btu's Δt 50°C	White Ex VAT	White Inc VAT	RAL Colours Ex VAT	RAL Colours Inc VAT	Special & Feature Finishes Ex VAT	Special & Feature Finishes Inc VAT
DELIVERY TIMES							48-72 HOURS		UP TO 2 WEEKS	
718	398	POPP7139	296	1010	£148.00	£177.60	£261.96	£314.35	£280.30	£336.36
	498	POPP7149	351	1198	£153.00	£183.60	£270.81	£324.97	£289.77	£347.72
	598	POPP7159	406	1385	£167.00	£200.40	£295.59	£354.71	£316.28	£379.54
1210	398	POPP1239	472	1610	£202.00	£242.40	£357.54	£429.05	£382.57	£459.08
	498	POPP1249	557	1900	£218.00	£261.60	£385.86	£463.03	£412.87	£495.44
	598	POPP1259	641	2187	£228.00	£273.60	£403.56	£484.27	£431.81	£518.17
1497	398	POPP1439	578	1972	£220.00	£264.00	£389.40	£467.28	£416.66	£499.99
	498	POPP1449	682	2327	£234.00	£280.80	£414.18	£497.02	£443.17	£531.80
	598	POPP1459	785	2678	£247.00	£296.40	£437.19	£524.63	£467.79	£561.35
1866	398	POPP1839	722	2463	£244.00	£292.80	£431.88	£518.26	£462.11	£554.53
	498	POPP1849	851	2904	£255.00	£306.00	£451.35	£541.62	£482.94	£579.53
	598	POPP1859	980	3344	£265.00	£318.00	£469.05	£562.86	£501.88	£602.26

Stock options Chrome

Height (mm)	Width (mm)	Model	Watts Δt 50°C	Btu's Δt 50°C	Chrome Ex VAT	Chrome Inc VAT		
DELIVERY TIMES							48-72 HOURS	
718	398	POPP7139C	183	624	£445.00	£534.00		
	498	POPP7149C	218	744	£449.00	£538.80		
	598	POPP7159C	252	860	£462.00	£554.40		
1210	398	POPP1239C	292	996	£598.00	£717.60		
	498	POPP1249C	345	1177	£600.00	£720.00		
	598	POPP1259C	398	1358	£628.00	£753.60		
1497	398	POPP1439C	359	1225	£652.00	£782.40		
	498	POPP1449C	423	1443	£661.00	£793.20		
	598	POPP1459C	487	1662	£686.00	£823.20		
1866	398	POPP1839C	448	1529	£707.00	£848.40		
	498	POPP1849C	528	1802	£715.00	£858.00		
	598	POPP1859C	608	2074	£745.00	£894.00		

23 RAL colours are shown on page 216

*Saving based on the value of individual items when bought separately. Order any of our selected valves & matching pipe covers at the same time as your radiator; PROMOV3W (white), PROMOV3C (chrome).

Made to order options - White electric

Height (mm)	Width (mm)	Model	Watts Δt 50°C	White Ex VAT	White Inc VAT		
DELIVERY TIMES						UP TO 6 WEEKS	
718	398	POPP7139EW	300	£354.00	£424.80		
	498	POPP7149EW	400	£357.00	£428.40		
	598	POPP7159EW	400	£369.00	£442.80		
1210	398	POPP1239EW	400	£403.00	£483.60		
	498	POPP1249EW	600	£422.00	£506.40		
	598	POPP1259EW	600	£430.00	£516.00		
1497	398	POPP1439EW	600	£424.00	£508.80		
	498	POPP1449EW	800	£437.00	£524.40		
	598	POPP1459EW	800	£447.00	£536.40		
1866	398	POPP1839EW	800	£444.00	£532.80		
	498	POPP1849EW	1000	£452.00	£542.40		
	598	POPP1859EW	1000	£465.00	£558.00		

Made to order options - Chrome electric

Height (mm)	Width (mm)	Model	Watts Δt 50°C	Chrome Ex VAT	Chrome Inc VAT		
DELIVERY TIMES						UP TO 8 WEEKS	
718	398	POPP7139EC	200	£637.00	£764.40		
	498	POPP7149EC	300	£642.00	£770.40		
	598	POPP7159EC	300	£652.00	£782.40		
1210	398	POPP1239EC	300	£781.00	£937.20		
	498	POPP1249EC	400	£784.00	£940.80		
	598	POPP1259EC	400	£811.00	£973.20		
1497	398	POPP1439EC	400	£832.00	£998.40		
	498	POPP1449EC	400	£843.00	£1,011.60		
	598	POPP1459EC	600	£867.00	£1,040.40		
1866	398	POPP1839EC	400	£885.00	£1,062.00		
	498	POPP1849EC	600	£893.00	£1,071.60		
	598	POPP1859EC	800	£922.00	£1,106.40		

398mm wide = 70mm-80mm
498mm wide = 68mm-78mm
598mm wide = 68mm-78mm

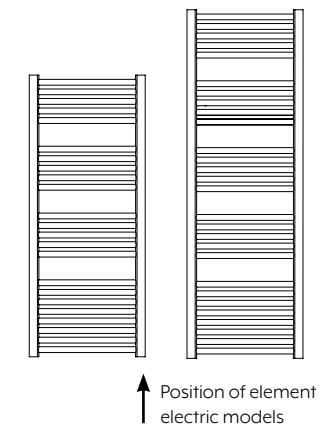

The Poppy Electric range is available with a fully controllable electric element. Offering 8 function modes, they can be set to operate on a daily basis or you can select one of the three pre-set programmes. If the Open Window function detects an open external door or window, it will turn off the radiator saving energy and money.

- Boost mode (2h at max power)
- Timer mode (configure different temperature values for each hour and day of the week),
- Comfort mode (desired user temperature),
- Night mode, Pilot-wire mode, Antifreeze mode, Holiday mode
- Adaptive Start Control, Open Window function, ON/OFF button and a security lock for children.

Feature Finishes

Painted in the UK our Feature Finishes give a personal touch to any room, choose from; Vintage Green, Aged Brass, Satin Gold, Textured Anthracite, Copper and Pearl Bronze.



Lupin Towel Rail shown on pages 106-107

High quality Italian design & manufacture
Steel; 25mm straight cross tubes with 40mm 'D' shaped collectors
CE/UKCA approved & certified to BS EN442.

White RAL 9016 as standard, 23 RAL colours, 31 Special Finishes & Chrome.
Please call **01342 302250** for a RAL or Special Finish chart.
6 Feature Finishes, see page 7 or call **01342 302250** for samples.

Stock White RAL 9016 & Chrome: 48-72 Hours

Made to Order RAL, Special & Feature Finishes: Up to 2 weeks
Up to 6 weeks for White electric, 8 weeks for Chrome electric.

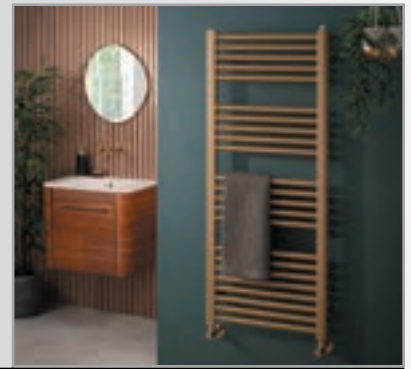

Cylinder Valve & Pipe Covers

SAVE £45*
WHEN YOU BUY OUR CYLINDER VALVE & PIPE COVERS WITH ANY TOWEL RAIL PURCHASE. QUOTE PROMOV3 AT TIME OF ORDER.

Available in White or Chrome

Pipe centres left to right	Pipe centres from wall	Depth from wall
width - 44mm	57mm to 67mm	72mm to 82mm

Stock options White RAL 9016

Height (mm)	Width (mm)	Model	Watts Δt 50°C	Btu's Δt 50°C	White Ex VAT	White Inc VAT	RAL Colours Ex VAT	RAL Colours Inc VAT	Special & Feature Finishes Ex VAT	Special & Feature Finishes Inc VAT
DELIVERY TIMES					48-72 HOURS		UP TO 2 WEEKS		UP TO 2 WEEKS	
718	400	LUPI7140	293	1000	£139.00	£166.80	£252.98	£303.58	£270.69	£324.83
	500	LUPI7150	363	1239	£142.00	£170.40	£258.44	£310.13	£276.53	£331.84
	600	LUPI7160	432	1474	£153.00	£183.60	£278.46	£334.15	£297.95	£357.54
1210	400	LUPI1240	472	1610	£184.00	£220.80	£334.88	£401.86	£358.32	£429.98
	500	LUPI1250	572	1952	£202.00	£242.40	£367.64	£441.17	£393.37	£472.04
	600	LUPI1260	671	2289	£211.00	£253.20	£384.02	£460.82	£410.90	£493.08
1497	400	LUPI1440	579	1976	£204.00	£244.80	£371.28	£445.54	£397.27	£476.72
	500	LUPI1450	700	2388	£218.00	£261.60	£396.76	£476.11	£424.53	£509.44
	600	LUPI1460	821	2801	£228.00	£273.60	£414.96	£497.95	£444.01	£532.81
1866	400	LUPI1840	717	2446	£225.00	£270.00	£409.50	£491.40	£438.17	£525.80
	500	LUPI1850	867	2958	£230.00	£276.00	£418.60	£502.32	£447.90	£537.48
	600	LUPI1860	1016	3467	£246.00	£295.20	£447.72	£537.26	£479.06	£574.87

Stock options Chrome

Height (mm)	Width (mm)	Model	Watts Δt 50°C	Btu's Δt 50°C	Chrome Ex VAT	Chrome Inc VAT
DELIVERY TIMES					48-72 HOURS	
718	400	LUPI7140C	202	689	£387.00	£464.40
	500	LUPI7150C	243	829	£389.00	£466.80
	600	LUPI7160C	285	972	£399.00	£478.80
1210	400	LUPI1240C	306	1044	£521.00	£625.20
	500	LUPI1250C	374	1276	£522.00	£626.40
	600	LUPI1260C	442	1508	£545.00	£654.00
1497	400	LUPI1440C	378	1290	£567.00	£680.40
	500	LUPI1450C	456	1556	£575.00	£690.00
	600	LUPI1460C	534	1822	£596.00	£715.20
1866	400	LUPI1840C	463	1580	£614.00	£736.80
	500	LUPI1850C	568	1938	£624.00	£748.80
	600	LUPI1860C	673	2296	£647.00	£776.40

23 RAL colours are shown on page 216

*Saving based on the value of individual items when bought separately. Order any of our selected valves & matching pipe covers at the same time as your radiator; PROMOV3W (white), PROMOV3C (chrome).

Made to order options - White electric

Height (mm)	Width (mm)	Model	Watts Δt 50°C	White Ex VAT	White Inc VAT
DELIVERY TIMES			UP TO 6 WEEKS		
718	400	LUPI7140EW	300	£343.00	£411.60
	500	LUPI7150EW	400	£348.00	£417.60
	600	LUPI7160EW	400	£357.00	£428.40
1210	400	LUPI1240EW	400	£387.00	£464.40
	500	LUPI1250EW	600	£403.00	£483.60
	600	LUPI1260EW	600	£412.00	£494.40
1497	400	LUPI1440EW	600	£408.00	£489.60
	500	LUPI1450EW	800	£422.00	£506.40
	600	LUPI1460EW	800	£430.00	£516.00
1866	400	LUPI1840EW	800	£426.00	£511.20
	500	LUPI1850EW	1000	£431.00	£517.20
	600	LUPI1860EW	1000	£446.00	£535.20

Made to order options - Chrome electric

Height (mm)	Width (mm)	Model	Watts Δt 50°C	Chrome Ex VAT	Chrome Inc VAT
DELIVERY TIMES			UP TO 8 WEEKS		
718	400	LUPI7140EC	200	£581.00	£697.20
	500	LUPI7150EC	300	£584.00	£700.80
	600	LUPI7160EC	300	£591.00	£709.20
1210	400	LUPI1240EC	300	£707.00	£848.40
	500	LUPI1250EC	400	£708.00	£849.60
	600	LUPI1260EC	400	£732.00	£878.40
1497	400	LUPI1440EC	400	£752.00	£902.40
	500	LUPI1450EC	400	£761.00	£913.20
	600	LUPI1460EC	600	£780.00	£936.00
1866	400	LUPI1840EC	400	£797.00	£956.40
	500	LUPI1850EC	600	£807.00	£968.40
	600	LUPI1860EC	800	£828.00	£993.60

157-67

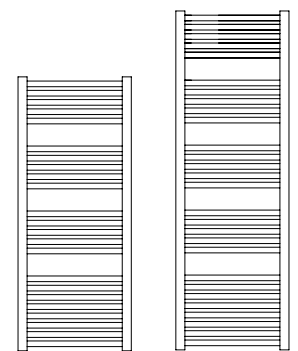

↑ Position of element electric models

Feature Finishes

Please see page 7 for details or call customer services for colour swatches.

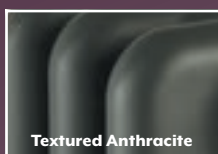
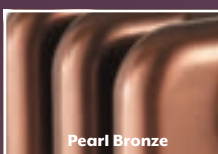

The Lupin Electric range is available with a fully controllable electric element. Offering 8 function modes, they can be set to operate on a daily basis or you can select one of the three pre-set programmes. If the Open Window function detects an open external door or window, it will turn off the radiator saving energy and money.

- Boost mode (2h at max power)
- Timer mode (configure different temperature values for each hour and day of the week),
- Comfort mode (desired user temperature),
- Night mode, Pilot-wire mode, Antifreeze mode, Holiday mode
- Adaptive Start Control, Open Window function, ON/OFF button and a security lock for children.

Iris shown on pages 108-109

Stainless Steel; 22mm cross tubes
Suitable for a direct system, Hydronic & Electric Models
CE/UKCA approved & certified to BS EN442.

Polished Stainless Steel.

Stock Polished Stainless Steel: 48-72 Hours
Made to Order electric: Up to 3 weeks



Cylinder Valve & Pipe Covers



SAVE £45*

WHEN YOU BUY OUR CYLINDER VALVE & PIPE COVERS WITH ANY TOWEL RAIL PURCHASE. QUOTE PROMOV3 AT TIME OF ORDER.

Available in White or Chrome

Pipe centres left to right	Pipe centres from wall	Depth from wall
width - 32mm	84mm	100mm

Stock options Polished Stainless Steel - Standard

Height (mm)	Width (mm)	Model	Watts Δt 50°C	Btu's Δt 50°C	Price Ex VAT	Price Inc VAT
DELIVERY TIMES					48-72 HOURS	
800	500	IRIS8050S	198	676	£568.00	£681.60
	600	IRIS8060S	233	795	£618.00	£741.60
1200	300	IRIS1230S	217	740	£691.00	£829.20
	500	IRIS1250S	314	1071	£724.00	£868.80
	600	IRIS1260S	371	1266	£817.00	£980.40

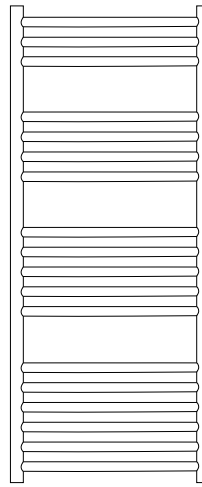

Stock options Polished Stainless Steel - Horizontal

Height (mm)	Width (mm)	Model	Watts Δt 50°C	Btu's Δt 50°C	Price Ex VAT	Price Inc VAT
DELIVERY TIMES					48-72 HOURS	
600	1000	IRIS6010S	517	1764	£728.00	£873.60
800	1000	IRIS8010S	682	2327	£806.00	£967.20

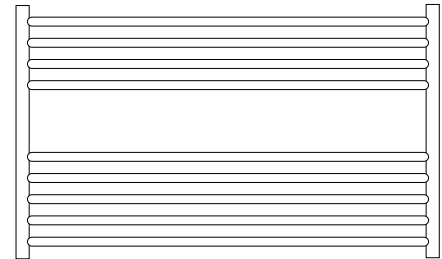

Made to order options - Standard electric

Height (mm)	Width (mm)	Model	Watts Δt 50°C	Price Ex VAT	Price Inc VAT
DELIVERY TIMES			UP TO 3 WEEKS		
800	500	IRIS8050ES	125	£788.00	£945.60
	600	IRIS8060ES	150	£838.00	£1,005.60
1200	300	IRIS1230ES	125	£911.00	£1,093.20
	500	IRIS1250ES	200	£944.00	£1,132.80
	600	IRIS1260ES	200	£1,037.00	£1,244.40

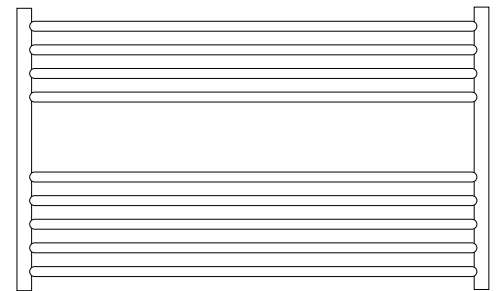
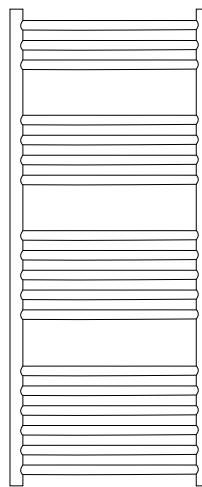

Position of element for electric models

Made to order options - Horizontal electric

Height (mm)	Width (mm)	Model	Watts Δt 50°C	Price Ex VAT	Price Inc VAT
DELIVERY TIMES			UP TO 3 WEEKS		
600	1000	IRIS6010ES	125	£948.00	£1,137.60
800	1000	IRIS8010ES	150	£1,026.00	£1,231.20

Position of element for electric models

Supplied with standard element and powered from a switched fused spur.

*Saving based on the value of individual items when bought separately. Order any of our selected valves & matching pipe covers at the same time as your radiator; PROMOV3W (white), PROMOV3C (chrome).

Lingfield shown on page 112

Brass tubed floor standing design, suitable for a direct system
CE/UKCA approved & certified to BS EN442.

Chrome (main image)
Antique Bronze
Antique Copper
Bright Nickel



Bright Nickel



Antique Bronze



Antique Copper

Stock Chrome: 48-72 Hours

Made to Order: Up to 10 weeks for Antique Bronze / Copper & Bright Nickel

Pipe centres left to right	Pipe centres from wall	Maximum depth from wall
width - 147mm - valves	118mm	235mm



Crosshead Valves



OUR CROSSHEAD VALVES ARE THE PERFECT MATCH FOR THESE TRADITIONAL STYLED TOWEL RAILS, SEE PAGE 125 FOR MORE INFORMATION AND PRICES.

Stock options Chrome

Height (mm)	Width (mm)	Model	Watts Δt 50°C	Btu's Δt 50°C	Chrome Ex VAT	Chrome Inc VAT
DELIVERY TIMES					48-72 HOURS	
850	600	LING8560	439	1498	£2,817.00	£3,380.40

Made to order options

Height (mm)	Width (mm)	Model	Watts Δt 50°C	Btu's Δt 50°C	Bright Nickel Ex VAT	Bright Nickel Inc VAT	Antique Bronze Ex VAT	Antique Bronze Inc VAT	Antique Copper Ex VAT	Antique Copper Inc VAT
DELIVERY TIMES					UP TO 10 WEEKS		UP TO 10 WEEKS		UP TO 10 WEEKS	
850	600	LING8560	439	1498	£3,101.00	£3,721.20	£3,517.00	£4,220.40	£3,517.00	£4,220.40

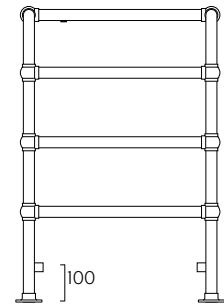
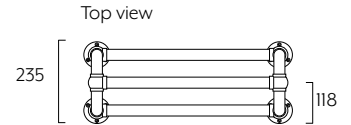

Linton Towel Rail shown on page 113

Steel tubes with a cast iron radiator
CE/UKCA approved & certified to BS EN442.

Chrome steel tubes, cast iron sections available in 188 RAL colours.
Please call **01342 302250** for a RAL chart.

Made to Order: Up to 7 weeks



Crosshead Valves



OUR CROSSHEAD VALVES ARE THE PERFECT MATCH FOR THESE TRADITIONAL STYLED TOWEL RAILS, SEE PAGE 125 FOR MORE INFORMATION AND PRICES.

Pipe centres left to right	Pipe centres from wall	Depth from wall
width - 122mm (+/- 2mm)- valves	140mm	315mm

Made to order options

Height (mm)	Width (mm)	Model	Watts Δt 50°C	Btu's Δt 50°C	Chrome/Colours Ex VAT	Chrome/Colours Inc VAT
DELIVERY TIMES					UP TO 7 WEEKS	
900	490	LINTR904903C	357	1218	£1,264.00	£1,516.80
	650	LINTR906505C	595	2030	£1,601.00	£1,921.20
	820	LINTR908207C	834	2846	£1,996.00	£2,395.20
1000	490	LINTR104903C	416	1419	£1,293.00	£1,551.60
	650	LINTR106505C	694	2368	£1,635.00	£1,962.00
1200	490	LINTR124903C	619	2112	£1,556.00	£1,867.20
	650	LINTR126505C	1031	3518	£1,969.00	£2,362.80

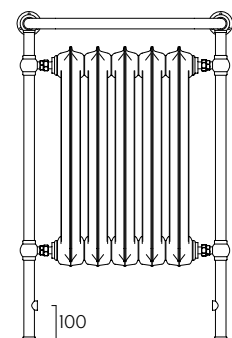
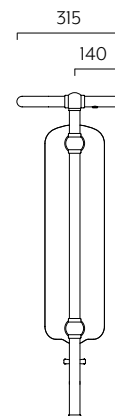

Chalfont Floor Standing shown on page 111



Brass tubes with a steel sectional radiator
CE/UKCA approved & certified to BS EN442.

Chrome with White Steel Radiator (main image)
Antique Bronze with Ivory Steel Radiator (shown below)
Antique Copper with Ivory Steel Radiator (shown below)
Bright Nickel with White Steel Radiator (shown below).

Stock Chrome: 48-72 Hours.

Made to Order: Up to 10 weeks Bright Nickel & Chrome Electric,
Antique Bronze and Antique Copper.



Pipe centres left to right	Pipe centres from wall	Maximum depth from wall
width - 157mm - valves	100mm	250mm

Crosshead Valves  OUR CROSSHEAD VALVES ARE THE PERFECT MATCH FOR THESE TRADITIONAL STYLED TOWEL RAILS, SEE PAGE 125 FOR MORE INFORMATION AND PRICES.

Stock options Chrome

Height (mm)	Width (mm)	Model	Watts Δt 50°C	Btu's Δt 50°C	Chrome Ex VAT	Chrome Inc VAT
DELIVERY TIMES					48-72 HOURS	
938	675	CHAL9367	554	1890	£1,931.00	£2,317.20
1500	500	CHAL1550	738	2518	£2,118.00	£2,541.60

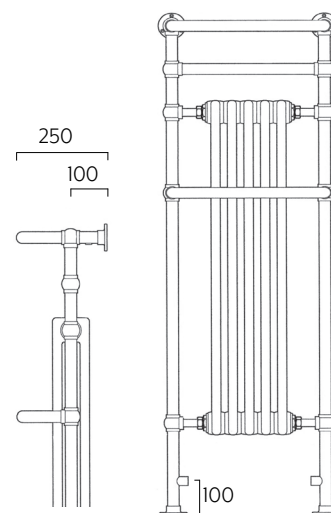

Made to order options

Height (mm)	Width (mm)	Model	Watts Δt 50°C	Btu's Δt 50°C	Bright Nickel Ex VAT	Bright Nickel Inc VAT	Antique Bronze Ex VAT	Antique Bronze Inc VAT	Antique Copper Ex VAT	Antique Copper Inc VAT
DELIVERY TIMES					UP TO 10 WEEKS		UP TO 10 WEEKS		UP TO 10 WEEKS	
938	675	CHAL9367	554	1890	£2,104.00	£2,524.80	£2,839.00	£3,406.80	£2,861.00	£3,433.20
1500	500	CHAL1550	738	2518	£2,338.00	£2,805.60	£2,901.00	£3,481.20	£2,978.00	£3,573.60



Bright Nickel



Antique Bronze



Antique Copper

Made to order options - Electric

Height (mm)	Width (mm)	Model	Watts Δt 50°C	Chrome Ex VAT	Chrome Inc VAT
DELIVERY TIMES			UP TO 10 WEEKS		
938	675	CHAL9367EC	400	£2,206.00	£2,647.20

Supplied with standard element and powered from a switched fused spur.

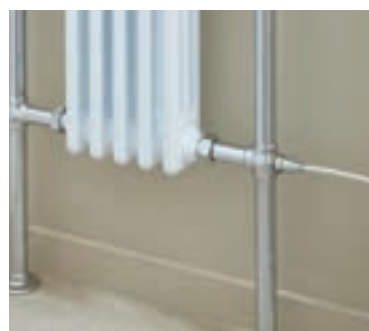

Chalfont Floor Standing Electric detail

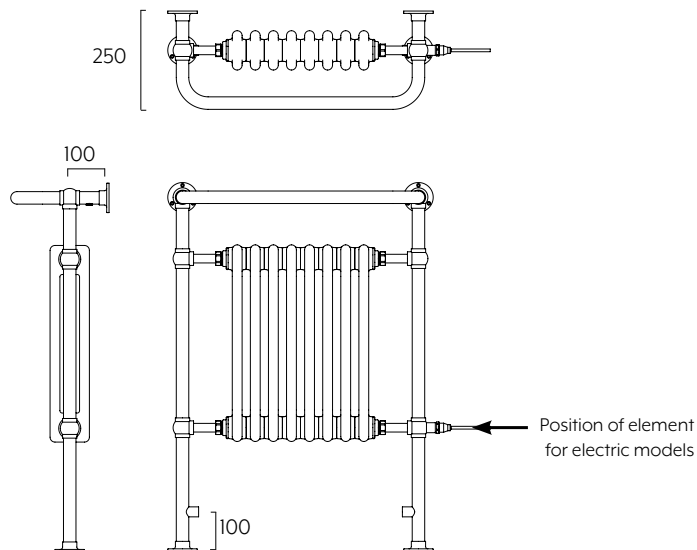

Chalfont Wall Hung shown on page 111

Brass tubed wall hung design, suitable for a direct system
CE/UKCA approved & certified to BS EN442.



Chrome (main image)

Antique Bronze, Antique Copper & Bright Nickel (shown below).

Stock Chrome: 48-72 Hours.

Made to Order: Up to 10 weeks Bright Nickel & Electric,
Antique Bronze and Antique Copper.



Pipe centres left to right	Pipe centre from wall	Maximum depth from wall
width - 75mm	50mm	125mm



OUR CROSSHEAD VALVES ARE THE PERFECT MATCH FOR THESE TRADITIONAL STYLED TOWEL RAILS, SEE PAGE 125 FOR MORE INFORMATION AND PRICES.

Stock options Chrome

Height (mm)	Width (mm)	Model	Watts Δt 50°C	Btu's Δt 50°C	Chrome Ex VAT	Chrome Inc VAT
DELIVERY TIMES					48-72 HOURS	
750	500	CHAL7550	169	577	£1,305.00	£1,566.00

Made to order options

Height (mm)	Width (mm)	Model	Watts Δt 50°C	Btu's Δt 50°C	Bright Nickel Ex VAT	Bright Nickel Inc VAT	Antique Bronze Ex VAT	Antique Bronze Inc VAT	Antique Copper Ex VAT	Antique Copper Inc VAT
DELIVERY TIMES					UP TO 10 WEEKS		UP TO 10 WEEKS		UP TO 10 WEEKS	
750	500	CHAL7550	169	577	£1,434.00	£1,720.80	£1,810.00	£2,172.00	£1,894.00	£2,272.80

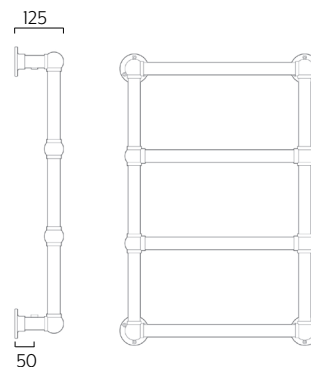

Bright Nickel

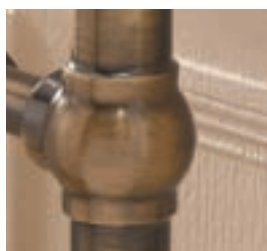

Antique Bronze



Antique Copper

Made to order options - Electric

Height (mm)	Width (mm)	Model	Watts Δt 50°C	Chrome Ex VAT	Chrome Inc VAT	Bright Nickel Ex VAT	Bright Nickel Inc VAT
DELIVERY TIMES				UP TO 10 WEEKS		UP TO 10 WEEKS	
750	500	CHAL7550E	100	£1,580.00	£1,896.00	£1,709.00	£2,050.80

Supplied with standard element and powered from a switched fused spur.

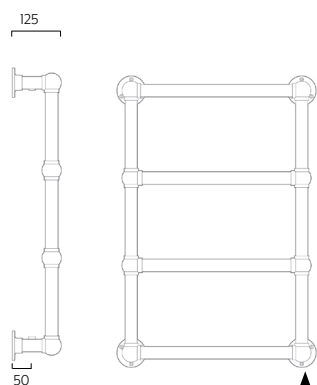

Position of element for electric models



Chalfont Wall Hung Electric in Chrome

Helpful Advice

Made to Order

We pride ourselves on having the widest range of sizes, options, colours, and accessories so that you have literally thousands of options to choose from. This means that you can have almost any radiator made to order so that it perfectly suits the space you have available, your interior design and also match your heat requirements.

Colour Options

Many of our designs are available in a large selection of RAL colours (188 internationally recognised paint colours) and Special Finishes. Please be aware that certain RAL colours may take longer to produce than listed in this brochure, if this is the case, we will make you aware of the revised delivery date and any alternative options. If you would like a copy of our RAL or Special Finish chart please contact us on **01342 302250**. Please note that due to the printing process and manufacturing tolerances, the colour (including white) of a finished radiator may vary slightly from the colours represented in the brochure and from one colour group to another, as well as from our Special Finish & RAL charts. It should also be noted that if the same type of radiators are ordered and produced, they may also differ in finished colour from any previously ordered.

Stock

To provide the best possible service, we hold the most popular sizes of white and chrome models in stock. So if you need quick delivery, look in the technical section for models listed with **bold** prices; these can usually be delivered within 48-72 hours.

How much heat?

We always recommend you choose radiators with a higher output than required, as you can always turn them down & have the reassurance of additional heat in really cold spells.

How is heat output measured?

There are two recognised measurements for heat output; BTU's (British Thermal Unit) and Watts. Within this brochure you will find both listed in the technical section by each radiator.

Delta T's

The heat output of a radiator is established using a calculation called a delta T (ΔT), based on the desired room temperature of 20°C and boiler flow and return temperatures; European standards use delta T50°C as a measurement, this is based on a boiler flow temperature of 80°C and a return of 60°C ($80^\circ\text{C} + 60^\circ\text{C} \div 2 - 20^\circ\text{C} = 50^\circ\text{C}$). Some systems using renewable energy sources may have different flow and returns and therefore different delta T's (e.g. $60^\circ\text{C}/40^\circ\text{C} = \text{delta T}30^\circ\text{C}$). If you require outputs based on alternative delta's please contact us on **01342 302250**.

BS EN442

Our radiators are produced & outputs measured according to BS EN442. This standard uses delta T50 to provide a consistent and comparative output measurement. Some installers may still use the old delta T60 as a measure of output. To convert use the following correction factors; $\Delta T50$ to $\Delta T60$ multiply by 1.267, $\Delta T60$ to $\Delta T50$ multiply by 0.781.

How can I find out what heat outputs I need?

Your installer should be able to confirm the exact requirements for each of your rooms, but you can also visit our website (theradiatorcompany.co.uk) and use our online heat calculator or use the following simple calculation as a guide;

1. Find the volume of your room in cubic feet = height x width x length (To convert cubic metres into cubic feet multiply the total figure by 35.31).
2. Multiply the volume by 6 to find the BTU requirement. If you need to know the Watts equivalent, divide your BTU by 3.412.

For example:

A bathroom 6'x8' with 8' ceilings = a volume of 384 cubic feet multiply by 6 = 2304 Btu's

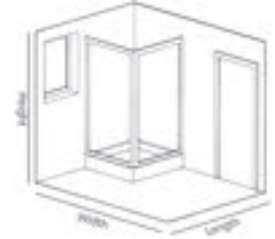

You may need more than 1 radiator in order to ensure an even distribution of heat in a large room, if so divide the required output by the total number of radiators you could sensibly place in the room.

e.g. a lounge 14' x 18' x 8' ceilings = 12096 Btu's.

Two radiators would require an output of = 6048 BTU's each,

3 radiators = 4032 BTU's each

Do different designs affect output?

By altering the size, shape or number of tubes or columns in a radiator you can adjust the output achieved, as this adds or subtracts surface area, the main contributor to heat output. For example, the multiple columns of our Ancona® range provide huge flexibility in achieving the right output in a limited space.



Single or double radiators

Using models with additional rows of tubes or multiple columns maximises heat output within the same wall space.

Our Water Lily design comes in single or double versions, as an example of comparative heat outputs:

Water Lily single 2020mm x 312mm = 2238 BTU's

Water Lily double 2020mm x 312mm = 3180 BTU's



Water Lily single



Water Lily double

Horizontal or Vertical;

Many of our designs are available in horizontal or vertical options which means you can maximise the use of ceiling heights and long low spaces, without losing output.

How to order

Order your radiator in seven easy steps

- 1. Confirm your heat output requirements for the room where you need the radiator or towel rail;** this ensures the radiators you choose will deliver the heat output you need. Use the BTU (heat output calculator) on our website theradiatorcompany.co.uk then decide how many radiators you need for the relevant room; discuss this and positions with your installer if needed.
- 2. Choose your design;** our range has everything from traditional cast iron to modern feature radiators, even an environmentally friendly aluminium range, with an extensive choice of sizes, colours & outputs.
- 3. Select a size that matches the heat output requirement;** outputs are shown in our technical section & will help you & your installer to find the best match for your needs.
- 4. Choose the colour you want;** with over 200 colours & special finishes you are able to match your colour scheme or introduce an accent colour to create a striking feature.
- 5. Find a valve to complete the look;** Choose from our wide selection of valves and add any accessories that complement your choice.
- 6. Order from your nearest showroom or merchant** to find your nearest branch call us on **01342 302250** or visit theradiatorcompany.co.uk
- 7. Order online from our website theradiatorcompany.co.uk**

For help in choosing a sectional radiator (modular radiators that can be built by section to achieve a size and/or output requirement), please visit our website to use one of our online radiator builders for Ancona® Steel Multi Column, Cast Iron and Sectional Aluminium.

Our Product Range

- All our radiators are produced and outputs measured in accordance with BS EN442 and as such are CE/UKCA approved.
- Radiators are supplied with BOE connections as standard unless otherwise stated. B2 underneath connections can be supplied with selected models. Full technical details can be found from **pages 128 to 213** and all details are in accordance with our factory or manufacturing partner's terms of reference at the time of going to print.
- Due to the excessively corrosive nature of chlorine, we do not recommend that radiators & towel rails are placed in swimming pool environments. In addition, radiators should not be located in areas that have long term exposure to high levels of moisture without suitable ventilation.
- When commissioning any radiator (including aluminium) on an indirect/closed system, we recommend using a suitable mixed metal inhibitor in suitable quantities to protect against scale & corrosion. We can provide the water content of our radiators if required to help the installer calculate this if needed.

Electric / Dual Fuel

Selected towel rails can be converted to work as dual fuel models. An element and T-piece are needed to adapt the towel rail; your installer will need to be aware if you wish to do this in order to adjust pipe centres accordingly. **See pages 114 - 115** for our range of elements. If a towel rail is suitable for dual fuel, it will be noted on the product technical page.

Pipe Centres

We endeavour to ensure all pipe centres are correct, however manufacturing tolerances must be considered. Therefore we strongly recommend that pipe work is not altered or adjusted until your new radiator or towel rail is delivered. The Radiator Company will not accept any responsibility for claims resulting from incorrect pipe centres.

Delta T's

The heat output of a radiator is established using a calculation called a delta T (ΔT), based on a desired room temperature of 20°C and boiler flow & return temperatures; European standards use delta T50°C as a measurement, this is based on a boiler flow temperature of 80°C and a return of 60°C ($80^\circ\text{C} + 60^\circ\text{C} \div 2 - 20^\circ\text{C} = 50^\circ\text{C}$). Some systems using renewable energy sources may have different flow and returns and therefore different delta T's (e.g $60^\circ\text{C}/40^\circ\text{C} = \text{delta T}30^\circ\text{C}$). If you require outputs based on alternative delta's please contact us on **01342 302250**.

Delivery

Please note that many of our factories close for 2-4 weeks during the holiday periods of July/August and December. This may extend the delivery period quoted for non stock made to order items ordered during July/August & December/January. We will confirm the expected delivery date on our order acknowledgement at the time of order. Unfortunately, delivery to Scotland / Offshore Islands may take longer due to the distances involved. Deliveries will be made to the nearest hard standing area.

Systems

All radiators and towel rails featured in this brochure are suitable for indirect/closed systems that comply with 'BS5449, section 1 forced circulation hot water systems'. Systems running with low pressures (under 1 Bar), microbore pipework or modern boilers with modulating pumps, may experience flow and heating issues if not accounted for in the system design which could result in radiators not heating fully or noisy pipework.

Direct heating systems use your hot water supply to heat a radiator; usually this will occur in a bathroom. If you have any radiators or towel rails linked to a direct system they should be made from either stainless steel or brass to avoid rusting and contaminating the hot water supply. However it should be noted that these radiators are not suitable for Direct systems fitted with a water softener.

Finishes and Painted Cast Iron

It should be noted that due to the production process colours can vary by +/- 5 to 10% from samples provided and between radiators ordered in the same colour at different times.

All painted cast iron radiators will be checked and tested prior to despatch. Care must be taken when handling and joining painted cast iron radiators on-site to avoid damaging the finish. Cast iron radiators will be supplied with a small bottle of touch up paint in case of damage to the finish during installation, however, it should be noted that this may vary slightly from the original finish. As a result of the casting process, cast iron radiators have a rough surface finish with small imperfections which will show after the painting process.

Terms & Conditions

For a copy of The Radiator Company full Terms & Conditions please call our Customer Services department on **01342 302250** or visit theradiatorcompany.co.uk

23 RAL Colours

For Sectional Aluminium, Torr , Canto, Iseo, Niro, Poppy & Lupin ranges



RAL 9010 - Pure white

Supplied as standard for Sectional Aluminium (Vip, Oscar, Mix & Vox) and the Canto
Optional RAL Colour for the Torr , Iseo, Niro and Poppy & Lupin ranges.



RAL 1001 - Beige



RAL 1013 - Oyster white



RAL 1015 - Light ivory



RAL 1019 - Grey beige



RAL 3000 - Flame red



RAL 3003 - Ruby red



RAL 3004 - Purple red



RAL 4003 - Heather violet



RAL 5024 - Pastel blue

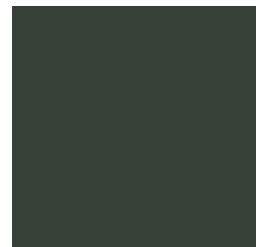

RAL 6006 - Grey olive



RAL 6013 - Reed green



RAL 7016 - Anthracite grey



RAL 7032 - Pebble grey

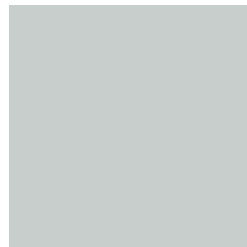

RAL 7035 - Light grey



RAL 7040 - Window grey



RAL 7042 - Traffic grey A



RAL 7044 - Silk grey

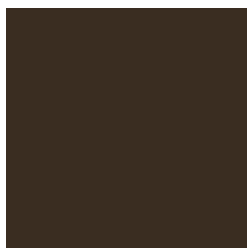

RAL 8011 - Nut brown

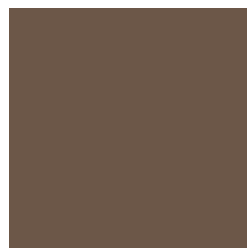

RAL 8025 - Pale brown

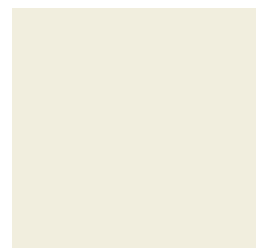

RAL 9001 - Cream

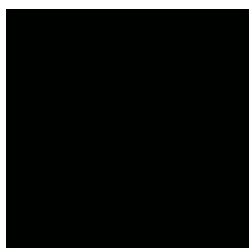

RAL 9004 - Signal black

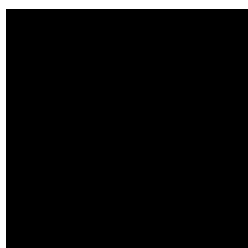

RAL 9005 - Jet black

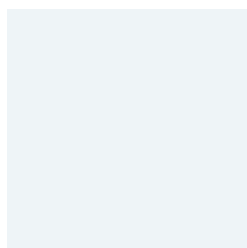

RAL 9016 - Traffic white

Please Note:

Due to printing processes and manufacturing tolerances, the colour of finished radiators may vary slightly from those colours shown on this page.

Please call **01342 302250** for a RAL chart.

Colour Coordination

We understand that many interior designs can be enhanced with carefully applied colour coordination or contrasts to create a standout feature. Today we have a huge choice of brands and exciting colour palettes and tones to choose from for our walls and woodwork, providing the opportunity to create truly stunning rooms. If you are looking to create a uniquely personal look using colours from either popular or premium paint brands, we can take your chosen colour and create a highly durable powder coat finish that will allow your radiator to blend in with your wall colour, or stand out if you want to make a statement!



Sitar radiator colour coordinated to Farrow & Ball® paint Citron 74

Making sure that you get something that reflects the effort you have taken in choosing your colours is important. Once we know the radiators you are interested in and the make, name and code of your chosen colour, we can supply a quote and an estimate of delivery times. **Please note that sometimes we will require a physical sample to colour match from.**

The first step is to order a colour sample, for which a small charge of £120 Inc VAT will apply (this will be deducted from the full order when placed). We will then mix a batch of powder and prepare a sample for you to check and approve. Once you are happy, you can proceed to order your radiators.

To achieve your desired colour and allow for the sample and final production, we have an extension on our standard delivery times to allow for the process, this could be up to 6 weeks for the sample, and once the sample has been approved, up to 8 weeks for the completion of your radiator order. Timescales will be determined by the size and quantity of radiators you require, we will be able to provide a more accurate estimation when we quote for your project.

The colour coordination icon indicates which products are available for this service and are shown on the relevant technical pages. Please call us on **01342 302250** or visit **theradiatorcompany.co.uk** for more information.



® Registered trademark of Farrow & Ball Holdings Limited



Oscar radiator with matching Pistol TRV's, pipe covers and shrouds colour coordinated to Dulux Natural Slate



Ancona radiator with matching Pistol TRV's, pipe covers and shrouds colour coordinated to Benjamin Moore paint Aegean Teal (2136-40)

Index

A	Pages
Aluminium Accessories	175
Aluminium, Sectional	62-71, 174-183
Ancona®	8-29, 128-147
Ancona® Bare Metal Lacquer	16-17, 136-137
Ancona® Bench seat	26-27, 144-145
Ancona® Curved	28, 146
Ancona® Electric	29, 147
Ancona® Made To order	18-25, 138-143
Ancona® Stock	8-17, 128-137
Ancona® Feature Finishes	7, 14-15, 128-135
Aston	76-77, 185
Athena	50-51, 172
Athena, BDO	90, 195
Athena Towel Rail	91, 195
B	
BDO Athena	90, 195
BDO Poll	102, 206
BDO Sitar	100, 198
BDO Step	88, 196
Black & Brass TRV	124
Blues	110, 202
C	
Ceramica Collection	36-37, 152
Canto	46, 156
Cast Iron Radiators	72-85, 184-194
Chalfont	111, 212-213
Chalfont Electric	111, 212-213
Clifton	78-79, 188
Colour coordination	217
Crosshead Valve	125
Cylinder Valve	125
D	
Designer Radiators	30-61, 148-173
Dual Fuel Elements & Valve	114-115
E	
Echo	93, 198
Echo Electric	93, 198
Electric Elements	114-115
Ellipsis	54-55, 162-165
Ellipsis Classic	98, 203

Ellipsis Towel Rail	99, 203
End panels (Vip, Oscar)	175-179
F	
Feature Finishes	7, 14-15
H	
Halo	60-61, 173
Henley	82-83, 192
I	
Ideal Corner TRV	120
Ideal TRV	121
Iris	108-109, 210
Iris Electric	108-109, 210
Iseo	42-43, 154
L	
Ledbury	74-75, 186
Lingfield	112, 211
Linton	80-81, 190-191
Linton Towel Rail	113, 211
Lupin	106-107, 209
Lupin Electric	106, 209
M	
Mini Cube Valve	125
Mix	70-71, 182-183
N	
New Technology Radiators	33-35, 95, 101
Niro	40-41, 153
NOW Smart Valves	118-119
O	
Oscar	66-67, 178-179
P	
Painted Valves	117
Piano	48-49, 158-159
Piano Electric	34, 150
Piano Lato	95, 200
Piano Lato Electric	95, 200
Piano Towel Rail	94, 199
Pipe Covers	117, 126
Pistol TRV	117, 124
Poll	103, 207
Poll Electric	103, 207
Poll, BDO	102, 206
Polygon	33, 151

Poppy	104-105, 208
Poppy Electric	104-105, 208
Pulsar	97, 202
Q	
Quadre	96, 201
R	
Relax	52-53, 160-161
Relax Bagno	92, 197
Relax Hybrid	32, 148-149
S	
Sax	58-59, 170-171
Sax Electric	35, 150
Sebino	44-45, 155
Sectional Aluminium	62-71, 174-183
Shrouds	117, 126
Sitar	56-57, 166-169
Sitar Lato	101, 204
Sitar Lato Electric	101, 204
Sitar Towel Rail	100, 205
Sitar, BDO	100, 198
Stamford	84, 194
Steel Multi Column	8-29, 128-147
Step	89, 196
Step Electric	196
Step, BDO	88, 196
Standard wall brackets	129/131/142
T	
Tinted Laquers	16-17, 136-137
Torré	38-39, 153
Towel Rail Section	86-113, 195-213
T-Pieces	115
V	
Valve Section	116-125
Vintage TRV	122
Vintage XL TRV	123
Vip	64-65, 176-177
Vox	68-69, 180-181
W	
Water Lily	47, 157
Wentworth	85, 193
3 Style valve	125





Design | Choice | Service

theradiatorcompany.co.uk

Tel. 01342 302250 Fax. 01342 302260 sales@theradiatorcompany.co.uk