

MERLYN™

THE COLLECTION

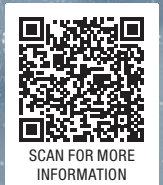

[MERLYNSHOWERING.COM](https://www.merlynshowering.com)

SEPT
2023

At MERLYN, our goal is to make a positive impact on the planet by taking various actions that are environmentally friendly. Planet Mark, a well-known sustainability certification body, has verified that we have calculated, lowered, and offset for our carbon footprint. We continue to work towards our goal with ongoing initiatives such as the electrification of our company vehicle fleet.

In line with our commitment to reduction in annual carbon footprint of 5% we have taken steps by collaborating with our offset partner, Ecologi.

In doing so, we are delighted to support a wind farm in Sri Lanka, a venture that aligns with our goal to drive environmental improvements and create a better planet.



SCAN FOR
INFORMATION
ON ECOLOGI



PlanetMark

MERLYN™
THE COLLECTION



Contents

about

The Collection	4
Welcome to MERLYN	6
MERLYN Customer Service	7

collections

MERLYN SERIES:

10 Series	8
8 Series Frameless	16
8 Series	28
6 Series	36

MERLYN IONIC:

Ionic Essence Frameless	50
Ionic Essence Framed	58
Ionic Express	66
Ionic Source	76

MERLYN Black	44
--------------------	----

MERLYN IQ	84
-----------------	----

The MERLYN Wetroom Collection	94
-------------------------------------	----

Bath Screens	108
--------------------	-----

MERLYN Trays:.....	126
--------------------	-----

TrueStone Trays	128
Level25 & Level25-SR Trays	130
Touchstone & Touchstone-SR Trays ...	134
Mstone.....	138
Upstand.....	141

technical information

Product Information	142
---------------------------	-----



MERLYN series

Style & Functionality



Exquisite product range. Balance of beauty and movement giving the user a sense of pure luxury and lifetime guarantee.

10 Series	Height: 2100mm	Glass: 10mm
8 Series Frameless	Height: 1950mm	Glass: 8mm
8 Series	Height: 1950mm	Glass: 8mm
6 Series	Height: 1900mm	Glass: 6mm

MERLYN IONIC

Easy Fit



Features high-quality materials and finishes, ensuring durability and longevity with lifetime guarantee.

Ionic Essence Framed	Height: 1900mm	Glass: 8mm
Ionic Essence Frameless	Height: 2000mm	Glass: 8mm
Ionic Express	Height: 1900mm	Glass: 6mm
Ionic Source (5year)	Height: 1900mm	Glass: 6mm

MERLYN™ | Wetrooms

Transform your bathroom into a modern and minimalist sanctuary with our wetroom solutions



MERLYN™

THE COLLECTION

It's all about the experience

Made up of shower enclosures, trays, wetrooms and bath screens, the MERLYN Supreme Collection is all about providing the ultimate showering experience – from the smooth running of the shower doors to the beautiful and elegant design and the quality of fittings.

MERLYN™ | BLACK

Sleek & Stylish



Favoured by interior designers and customers seeking a modern look with lifetime guarantee.

MERLYN Black Height up to 2000mm Glass: 8mm



The easiest door you will ever fit!



One person install, uses no screws on the frame assembly and is built on the tray, with 10 year guarantee.

MERLYN IQ Height: 1900mm Glass: 8mm

MERLYN™

it's all about the experience

Introducing The Collection Brochure, thoughtfully curated to showcase the very best of MERLYN's versatile product range under one cover.

At MERLYN, our commitment to innovation, quality and design permeates throughout this product offering.

This unique approach has helped us to become the leading brand for shower enclosures in the UK and Ireland.

When you choose a MERLYN shower, now conveniently portrayed in this New Collection Brochure, you are investing in one of the most trusted shower brands, backed up by a Lifetime Guarantee giving you total peace of mind .

Thank you for choosing MERLYN.

Sincerely,

The MERLYN Team



Follow us online @merlynshowering to keep up to-date.









Award-Winning Customer Service

It is not about what we do but what we can do for you. We promise we will always be there for you at any stage of your journey with MERLYN. We have a genuine commitment to service and to finding a solution for you. Our specialised team's philosophy is to make everything easy for you and we will respond immediately to any request you might have.

We strive everyday to make excellence a habit. Contact our award winning dedicated team of specialists, who are on hand to give you a personalised solution to your query.

 T: 0808 101 1429  WhatsApp: +353 8601 00 002  E: sales@merlyn.ie

-  Download our brochures
-  Find your nearest stockist
-  Download our easy-to-use fitting instructions and technical information
-  Register your Guarantee

Check out our website: merlynshowering.com





10 | series

Exquisite design

This range is the flagship of the MERLYN Series collection, showcasing the very finest in style and quality. These elegantly crafted solid doors allow you to add your own personal touch. An excellent choice for those looking for a statement piece in the bathroom.



Quiet glide wheels



A choice of handles to suit your own personal style



Stunningly crafted transparent glass



10 Series Sliding Door in Recess / Shown as Right Hand (R)

Technical drawing

Sliding Door in Recess



Size	X Min-Max	A	B
1000	405-300	470	510
1100	455-350	520	560
1200	505-400	570	610
1400	605-500	670	710
1500	605-500	670	810
1600	605-500	670	910
1700	605-500	670	1010

- A: Moving Panel
- B: Fixed Panel
- D: Side Panel
- X: Door Opening

Opening size can be adjusted to your requirements

A total of 35mm adjustment (max of 12mm adjustment in wall profile on closing side for out of true walls i.e. on right hand side of image shown). Extension profiles available. See page 143.

Sliding Door with Side Panel

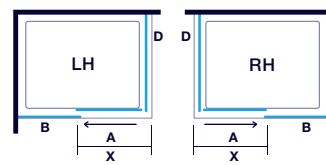

Size	D
760	665
800	705
900	805

Sliding Door

Our sliding door in recess is a definite style statement. While minimalist in appearance it has an impressive 10mm toughened glass, making it the flagship of the MERLYN Series Collection range.

features

- » Height 2100mm
- » Eyelet handle with chrome eyelet option and circular filler plate option
- » Extra smooth roller action for quiet closing
- » Door handed - order Left Hand (L) or Right Hand (R)
- » Wetroom compatible

Sliding Door in Recess

Size	Tray Finish Adjustment	Code	Price £ Exc. VAT	Price £ Inc. VAT
1000	950-985	M108231C L or R	1957.88	2349.46
1100	1050-1085	M108251C L or R	1957.88	2349.46
1200	1150-1185	M108241C L or R	1957.88	2349.46
1400	1350-1385	M108291C L or R	2042.97	2451.56
1500	1450-1485	M108281C L or R	2225.96	2671.15
1600	1550-1585	M108271C L or R	2270.02	2724.02
1700	1650-1685	M1081700CH L or R	2315.89	2779.07

This product is handed please choose L for left and R for right when ordering.
Please add 15mm to tray finish adjustment when using a Side Panel.

Optional Side Panel

Size	Tray Finish Adjustment	Order Code	Price £ Exc. VAT	Price £ Inc. VAT
760	730-750	M102210C	889.10	1066.92
800	770-790	M102211C	889.10	1066.92
900	870-890	M102221C	889.10	1066.92

Please Note: Moving panel door must close onto the side panel.
For wetroom installation, please reduce tray finish adjustment by 20mm.



SCAN FOR MORE
INFORMATION



Sliding Door with Side Panel



1 Door Offset Quadrant / Shown as Right Hand (R)

Technical drawing

1 Door Offset Quadrant

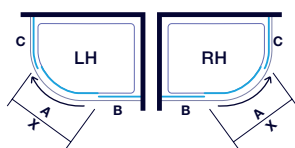

Size	X Min-Max	A	B	C
1000 x 800	435-340	520	535	435
1200 x 800	435-340	520	535	635
1200 x 900	485-390	580	575	635
1400 x 800	435-340	520	535	835

1 Door Quadrant

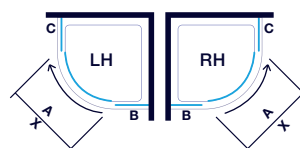

Size	X Min-Max	A	B	C
800	435-340	520	535	235
900	485-390	580	575	340

A: Moving panel
B: Straight Panel

C: Curved Panel
X: Door Opening

All sizes suit 550mm radius tray.
Note: Curved Panels 8mm glass. Extension profiles available. See page 143.

1 Door Quadrants

Beautifully curved glass combined with an exceptionally smooth roller action makes this quadrant door the best in its class. Constructed from up to 10mm toughened glass this stunning enclosure offers strength and practicality which belies its beauty.

features

- » Height 2000mm
- » Up to 10mm toughened glass
- » Eyelet handle with chrome eyelet option and circular filler plate option
- » Extra smooth roller action for quiet closing
- » Door handed-order Left Hand (L) or Right Hand (R)
- » Wetroom compatible

1 Door Quadrant

Size	Tray Finish Adjustment	Code	Price £ Exc. VAT	Price £ Inc. VAT
800 x 800	775-795	M103211C L or R	2417.74	2901.29
900 x 900	875-895	M103221C L or R	2374.01	2848.81
1000 x 800	975-995 / 775-795	M103233C L or R	2458.15	2949.78
1200 x 800	1175-1195 / 775-795	M103243C L or R	2731.87	3278.24
1200 x 900	1175-1195 / 875-895	M103241C L or R	2733.44	3280.13
1400 x 800	1375-1395 / 775-795	M10148H L or R	2921.78	3506.13

This product is handed please choose L for left and R for right when ordering.

MERLYN Dedicated Offset Quadrant Tray (1400 x 800)

Size	Tray Finish Adjustment	Code	Price £ Exc. VAT	Price £ Inc. VAT
1400 x 800		S148Q L or R	371.49	445.79

Please Note: The 1400mmx800mm tray is not an MStone Tray, it is a dedicated single skinned tray.



SCAN FOR MORE
INFORMATION



1 Door Quadrant

Pivot Door

The 10 Series Pivot Door is bound to impress in any bathroom. Its substantial 10mm toughened glass and solid chrome angular double handle provide a style statement that befits the beauty of this door.

features

- » Height 2030mm
- » Solid chrome handle
- » Fully concealed fixings
- » Reversible
- » Wetroom compatible



Pivot Door in Recess / Shown as Left Hand (L)



Pivot Door with Side Panel

Pivot Door in a recess

Size	Tray Finish Adjustment	Order Code	Price £ Exc. VAT	Price £ Inc. VAT
800	760-790	M101211C	1674.20	2009.04
900	860-890	M101221C	1687.38	2024.86
1000	960-990	M101231C	1773.90	2128.68

Please reduce tray finish adjustment by 10mm when using a Side Panel.

Optional Side Panel

Size	Tray Finish Adjustment	Order Code	Price £ Exc. VAT	Price £ Inc. VAT
800	770-790	M10P2211C	832.08	998.50
900	870-890	M10P2221C	869.49	1043.39
1200	1170-1190	M10P2241C	1067.28	1280.74

Please Note: Moving panel door must close onto the Side Panel.
For wetroom installation, please reduce tray finish adjustment by 30mm.

Technical drawing

Pivot Door in Recess

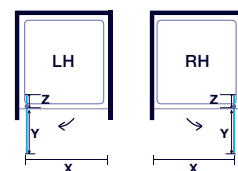

Pivot Door with Side Panel

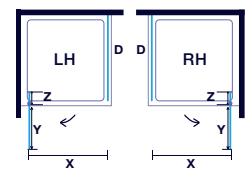

D: Side Panel
Y: Outside Door Swing
Z: Inside Door Swing
X: Door Opening

Size	X Min-Max	Y	Z
800	560	580	135
900	660	680	135
1000	760	780	135

Note: 10mm adjustment only on closing side.
Extension profiles available.
See page 143.

Pivot Door & Inline Panel

MERLYN'S 10 Series Pivot Door & Inline Panel is a luxurious showering choice with solid chrome double handle and 10mm toughened safety glass. Flexible size options available from 1200mm to 1800mm.

features

- » Height 2030mm
- » Solid chrome handle
- » Fully concealed fixings
- » Reversible
- » Wetroom compatible



Pivot Door & Inline Panel / Shown as Left Handed



Pivot Door & Inline Panel in Recess

Pivot Door and Inline Panel

Size	Tray Finish Adjustment	Size of Pivot Door Supplied	Size of Pivot Inline Panel Supplied	Code	Price £ Exc. VAT	Price £ Inc. VAT
1200	1150-1190	800	400	M101241C	2306.27	2767.52
1400	1350-1390	800	600	M101291C	2419.10	2902.92
1500	1450-1490	900	600	M101261C	2432.28	2918.74
1600	1550-1590	800	800	M101271C	2554.57	3065.49
1700	1650-1690	900	800	M101281C	2567.73	3081.28
1800	1750-1790	1000	800	M101218C	2654.20	3185.04

Optional Pivot Door and Inline Panel Side Panel

Size	Tray Finish Adjustment	Code	Price £ Exc. VAT	Price £ Inc. VAT
800	770-790	M10PIL2211C	824.97	989.96
900	870-890	M10PIL2221C	889.10	1066.92

For wetroom installation, please reduce tray finish adjustment by 10mm.
Please Note: Moving panel door must close onto the Inline Panel.

Technical drawing

Pivot Door & Inline Panel in Recess

Pivot Door & Inline Panel with Side Panel



C: Fixed Panel
D: Side Panel
Y: Outside Door Swing
X: Door Opening

Extension profiles available.
See page 143.

Size	X Min-Max	Y	C
1200	560	580	410
1400	560	580	610
1500	660	680	610
1600	560	580	810
1700	660	680	810
1800	760	780	810



8^{MM}
GLASS
THICKNESS

LIFETIME
GUARANTEE

MERSHIELD™
STAYCLEAR

8 | series | *frameless*

8 | series | *frameless*

A minimalist, designer frame.

This range has a minimalist frame design, one of the most popular trends in shower enclosures. The frameless design gives a refined look, while enhancing the sense of space and light in your bathroom. The frameless design is easy to clean and maintain.



Quiet glide wheels



Ultra slim hinges for added style

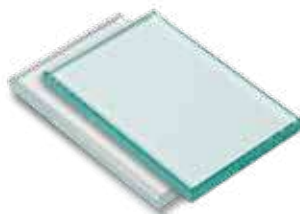

Crafted transparent glass



Our exclusive horizontal handle which offers the perfect symmetry and solid feel to this truly stunning range.

SHOWER ENCLOSURES



Sliding Door with Side Panel / Shown as Right Hand (R)

Technical drawing

Sliding Door in Recess

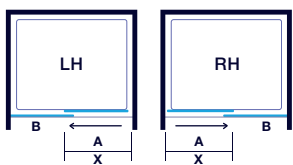

Sliding Door with Side Panel

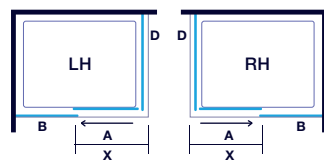

- A: Moving panel
- B: Fixed Panel
- D: Side Panel
- X: Door Opening

Size	X	A	B	D
1200	450	605	565	710
1400	550	705	665	810



Sliding Door

The 8 Series Frameless Sliding Door has the smoothest rolling action that needs to be seen to be believed. With its sleek minimalist frame and stunning designer features; it will bring a touch of class to any bathroom.

features

- » Height 2000mm
- » Concealed fixings
- » Mershield Stayclear™ easy clean protected glass
- » Translucent seals
- » Reversible
- » Wetroom compatible
- » Lifetime Guarantee

Sliding Door

Size	Tray Finish Adjustment	Code	Price £ Exc. VAT	Price £ Inc. VAT
1200	1150-1190	A0920DH	1288.67	1546.41
1400	1350-1390	A0920HH	1484.78	1781.74

Please add 20mm to tray finish adjustment when using a Side Panel.

Optional Side Panel

Size	Tray Finish Adjustment	Code	Price £ Exc. VAT	Price £ Inc. VAT
800	765-790	A0920LH	674.27	809.13
900	865-890	A0920PH	715.22	858.26

For wetroom installation, please reduce tray finish adjustment by 20mm.

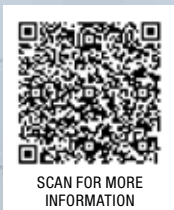



Hinged Bifold Door in Recess / Shown as Right Hand (R)

Technical drawing

Hinged Bifold Door in Recess

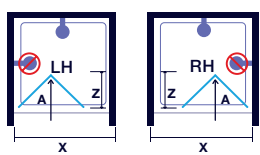

Hinged Bifold Door with Side Panel

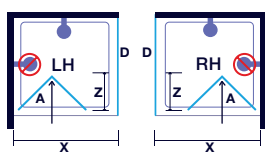

Size	X	Z	A
760	520	355	309/309
800	560	375	329/329
900	670	425	379/379
1000	780	475	429/429

X: Door Opening

Z: Width of panel when folded

Extension profiles available. See page 143.



Hinged Bifold Door

The 8 Series Frameless Bifold is an ingenious space saving solution for bathrooms with space restrictions, the hero of the bijou bathroom. Folding away neatly and horizontally flush to the wall, this screen allows you to double your feeling of space in any small bathroom giving you that extra elbow room you desire.

features

- » Height 1950mm
- » Frameless
- » Minimal designer hinges
- » Space solution
- » Reversible

Hinged Bifold Door				
Size	Tray Finish Adjustment	Code	Price £ Exc. VAT	Price £ Inc. VAT
760	720-750	M87111	973.27	1167.92
800	760-790	M87211	1006.87	1208.24
900	860-890	M87221	1072.42	1286.91
1000	960-990	M87231	1107.74	1329.28

Please reduce tray finish adjustment by 5mm when using a Side Panel.

Optional Side Panel				
Size	Tray Finish Adjustment	Code	Price £ Exc. VAT	Price £ Inc. VAT
760	715-735	M82101	642.11	770.53
800	755-775	M82102	642.11	770.53
900	855-875	M82103	680.78	816.94

For wetroom installation, reduce tray finish adjustment by 5mm.
Please note: Moving panel door must close onto the Side Panel.

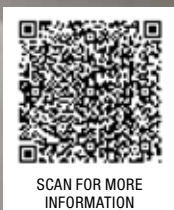

SCAN FOR MORE INFORMATION



Hinged Bifold Door with Side Panel

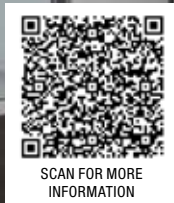

1 Door Offset Quadrant / Shown as Left Hand (L)

1 Door Quadrants

The stylish 8 Series Frameless Offset Quadrant comes in a range of sizes, providing a spacious showering space that would suit any type of bathroom, traditional or contemporary.

features

- » Height 2000mm
- » Large horizontal designer handle
- » Secure “Clunk” closing
- » Ultra slim hinges
- » Concealed fixings
- » Reversible
- » Wetroom compatible

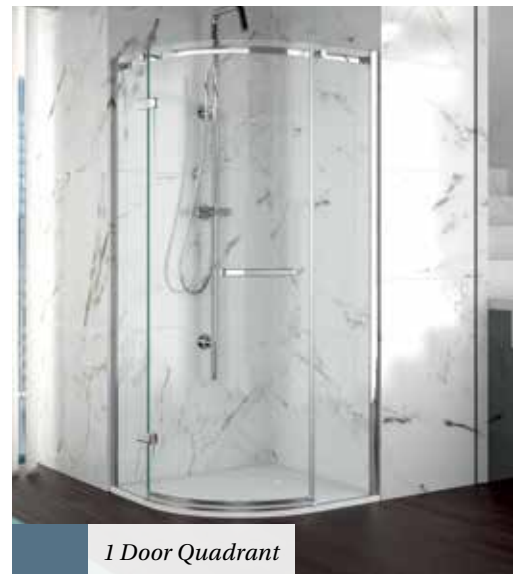

1 Door Quadrant

1 Door Quadrant

Size	Tray Finish Adjustment	Code	Price £ Exc. VAT	Price £ Inc. VAT
800 x 800	780-800	A0601TH	1735.81	2082.97
900 x 900	880-900	A0601UH	1735.81	2082.97
1000 x 1000	980-1000	A0602ZH	1875.91	2251.09
900 x 760	880-900 / 740-760	A0601CH	2068.95	2482.74
1000 x 800	980-1000 / 780-800	A0601EH	2085.34	2502.41
1200 x 800	1180-1200 / 780-800	A0601HH	2153.70	2584.44
1200 x 900	1180-1200 / 880-900	A0601IH	2153.70	2584.44

Technical drawing

1 Door Offset Quadrant

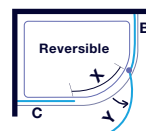

Size	X	Y	B	C
900 x 760	720	790	195	335
1000 x 800	720	790	235	435
1200 x 800	720	790	235	635
1200 x 900	720	790	335	635

1 Door Quadrant

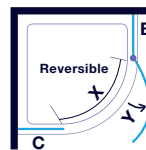

Size	X	Y	B	C
800	720	790	235	235
900	720	790	335	335
1000	720	790	435	435

B: Hinged Fixed Panel
C: Fixed Panel
X: Door Opening
Y: Panel Swing

All sizes to suit a 550mm Radius Tray. Extension profiles available. See page 143.



Pivot Door

The 8 Series Frameless Pivot Door is practical, stylish and the perfect solution for recess and corner situations. At a height of 1950mm, this enclosure is the perfect choice.

features

- » Height 1950mm
- » Solid chrome double handle
- » Cover caps
- » Space saving solution
- » Inward and outward opening swing
- » Concealed fixings
- » Reversible
- » Wetroom compatible

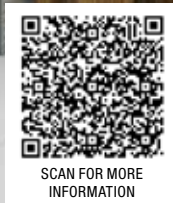

Pivot Door with Side Panel / Shown as Right Hand (R)



Pivot Door in Recess

Pivot Door in a Recess

Size	Tray Finish Adjustment	Code	Price £ Exc. VAT	Price £ Inc. VAT
760	730-760	S8FPV76	755.33	906.39
800	770-800	S8FPV80	783.90	940.68
900	870-900	S8FPV90	826.73	992.07
1000	970-1000	S8FPV100	855.29	1026.35

Optional Pivot Door Side Panel

Size	Tray Finish Adjustment	Code	Price £ Exc. VAT	Price £ Inc. VAT
760	735-755	S8FSP76PV	616.83	740.19
800	775-795	S8FSP80PV	616.83	740.19
900	875-895	S8FSP90PV	653.96	784.75
1000	975-995	S8FSP100PV	749.63	899.55
1200	1175-1195	S8FSP120PV	849.58	1019.49

For wetroom installation, please reduce tray finish adjustment by 10mm.

Technical drawing

Pivot Door Recess



Pivot Door with Side Panel

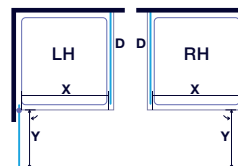

Size	X	Y
760	642	640
800	682	680
900	782	780
1000	882	880

X: Door Opening
Y: Outside Door Swing

Note: 10mm adjustment only on closing side.
Extension profiles available. See page 143.



Hinge and Inline Door in Recess / Shown as Right Hand (R)

Technical drawing

Hinge and Inline Door a Recess

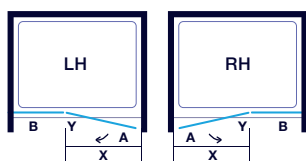

Hinge and Inline Door with Side Panel

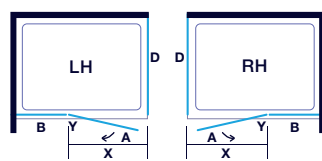

A: Moving Panel
 B: Fixed Panel
 D: Side Panel
 Y: Door Swing
 X: Door Opening

Size	X	Y	B
900	560	630	240
900+	560	630	285
1000	645	710	260
1000+	690	755	260
1100	645	710	360
1100+	690	755	360
1200	645	710	460

Size	X	Y	B
1200+	690	755	460
1400	645	710	660
1400+	690	755	660
1600	645	710	860
1600+	690	755	860
1700	645	710	960
1700+	690	755	960

Extension profiles available. See page 143.



Hinge and Inline

A hugely practical yet stylish option, the 8 Series Frameless Hinge & Inline in a Recess is perfect for recesses or en suites. The Hinge and Inline redefines the art of showering with its creative fusion of style and practicality.

features

- » Height 2000mm
- » Large horizontal designer handle including internal clutch bar handle
- » Secure “Clunk” closing
- » Ultra slim hinges
- » Concealed fixings
- » Reversible
- » Wetroom compatible

Hinge and Inline in a Recess

Size	Tray Finish Adjustment	Code	Price £ Exc. VAT	Price £ Inc. VAT
900	860-905	A0611X0	1506.14	1807.37
900+	905-950	A0611Y0	1506.14	1807.37
1000	960-1005	A0611RH	1506.14	1807.37
1000+	1005-1050	A0611RF	1506.14	1807.37
1100	1060-1105	A0611SH	1609.19	1931.03
1100+	1105-1150	A0611SF	1609.19	1931.03
1200	1160-1205	A0611TH	1631.96	1958.36
1200+	1205-1250	A0611TF	1631.96	1958.36
1400	1360-1405	A0611UH	2048.76	2458.51
1400+	1405-1450	A0611UF	2048.76	2458.51
1600	1560-1605	A0611VH	2127.57	2553.09
1600+	1605-1650	A0611VF	2127.57	2553.09
1700	1660-1705	A0611WH	2194.07	2632.88
1700+	1705-1750	A0611WF	2194.06	2632.87

Please Note: + Sizes indicate opening when fitted with side panel

Hinge and Inline sizes must be used with Side Panel

Size	Tray Finish Adjustment	Code	Price £ Exc. VAT	Price £ Inc. VAT
900+	880-900	A0611Y0	1506.14	1807.37
1000+	980-1000	A0611RF	1506.14	1807.37
1100+	1080-1100	A0611SF	1609.19	1931.03
1200+	1180-1200	A0611TF	1631.96	1958.36
1400+	1380-1400	A0611UF	2048.76	2458.51
1600+	1580-1600	A0611VF	2127.57	2553.09
1700+	1680-1700	A0611WF	2194.06	2632.87

Optional Side Panel

Size	Tray Finish Adjustment	Code	Price £ Exc. VAT	Price £ Inc. VAT
760	740-760	A0607B0	673.71	808.46
800	780-800	A0607D0	673.71	808.46
900	880-900	A0607E0	673.71	808.46

Please note: Moving panel door must close onto the Side Panel. For wetroom installation, please reduce tray finish adjustment by 20mm.



Hinge and Inline with Side Panel

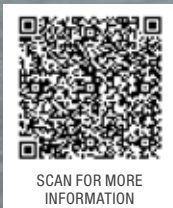

SCAN FOR MORE INFORMATION



Pivot and Inline Door with Side Panel / Shown as Right Hand (R)

Technical drawing

Pivot and Inline Door a Recess

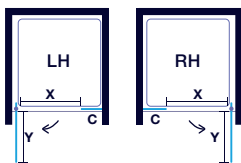

C: Fixed Panel
Y: Door Swing
X: Door Opening

Pivot and Inline Door in Recess

Enclosure Size	Door Size	Inline Size	X	Y	C
1000	800	200	682	680	218
	800	300	682	680	318
1100	900	200	782	780	218
	800	400	682	680	418
1200	900	300	782	780	318
	1000	200	882	880	218
	800	500	682	680	518
1300	900	400	782	780	418
	1000	300	882	880	318
1400	900	500	782	780	518
	1000	400	882	880	418
	1000	500	882	880	518
1500	800	700	682	680	718
1600	900	700	782	780	718
1700	1000	700	882	880	718

Pivot and Inline Door with Side Panel

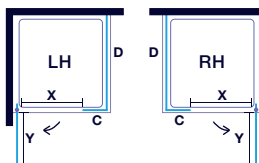

C: Fixed Panel
Y: Door Swing
X: Door Opening

Pivot and Inline Door with Side Panel

Enclosure Size	Door Size	Inline Size	X	Y	C
1000	800	200	682	680	225
	800	300	682	680	325
1100	900	200	782	780	225
	800	400	682	680	425
1200	900	300	782	780	325
	1000	200	882	880	225
	800	500	682	680	525
1300	900	400	782	780	425
	1000	300	882	880	325
1400	900	500	782	780	525
	1000	400	882	880	425
	1000	500	882	880	525
1500	800	700	682	680	725
1600	900	700	782	780	725
1700	1000	700	882	880	725

Extension profiles available. See page 143.

Pivot Door & Inline Panel

This new addition to the 8 Series Frameless range brings with it choice and a range of size options to fit a varied space. This beautiful enclosure epitomises style and practicality.

features

- » Height 1950mm
- » Solid chrome double handle
- » Cover caps
- » Space saving solution
- » Inward and outward opening swing
- » Concealed fixings
- » Reversible
- » Wetroom compatible

Pivot Door and Inline Panel in a Recess

Size	Size of Pivot Door	Inline Panels	Tray Finish Adjustment	Code	Price £ Exc. VAT	Price £ Inc. VAT
1000	800	200	960-1000	S8FPI1002H	1139.42	1367.30
1100	800	300	1060-1100	S8FPI1103H	1167.98	1401.58
	900	200		S8FPI1102H	1167.98	1401.58
1200	800	400	1160-1200	S8FPI1204H	1196.53	1435.84
	900	300		S8FPI1203H	1196.53	1435.84
	1000	200		S8FPI1202H	1196.53	1435.84
** 1300	800	500	1260-1300	S8FPI1305H	1225.10	1470.12
	900	400		S8FPI1304H	1225.10	1470.12
	1000	300		S8FPI1303H	1225.10	1470.12
1400	900	500	1360-1400	S8FPI1405H	1253.65	1504.38
	1000	400		S8FPI1404H	1253.65	1504.38
1500	1000	500	1460-1500	S8FPI1505H	1282.20	1538.64
	800	700		S8FPI1507H	1282.20	1538.64
1600	900	700	1560-1600	S8FPI1607H	1312.20	1574.64
1700	1000	700	1660-1700	S8FPI1707H	1330.72	1596.86

Please Note: Items in bold are our recommended configurations. **Available with TouchStone Tray Only
Please Note: If you would like the **door to open fully against the wall** please refer to the sizes in panel B (door swing) in the relevant table on page 148.

Optional Pivot Door and Inline Side Panel

Size	Tray Finish Adjustment	Code	Price £ Exc. VAT	Price £ Inc. VAT
760	735-755	S8FSP76IN	616.83	740.19
800	775-795	S8FSP80IN	616.83	740.19
900	875-895	S8FSP90IN	653.96	784.75

For wetroom installation, please reduce tray finish adjustment by 10mm.
For more information on the Side Panel refer to the Technical drawing page 148.



SCAN FOR MORE
INFORMATION



Inward Swing

Pivot and Inline / Overhead
Shown with Side Panel



Outward Swing

Pivot and Inline / Overhead
Shown with Side Panel





8^{MM}
GLASS
THICKNESS

LIFETIME
GUARANTEE

MERSHIELD™
STAYCLEAR

8 | series

Style, ingenious functionality.

This range of elegant 8mm glass shower enclosures offer a variety of shapes and sizes to suit your preference. Each product delivers a style expression that enhances the feeling of space in the bathroom. Built with ingenious functionality to guarantee a seamless and safe operation.



*Easy clean push & release
double rollers*

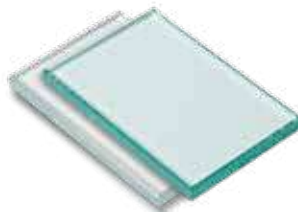

*Stunningly crafted
transparent glass*

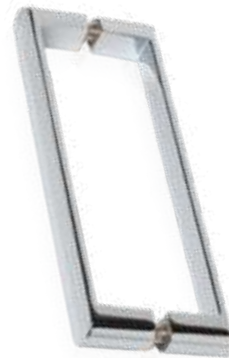

*Ergonomic handle designed
for that effortless close.*

8 | series

SHOWER ENCLOSURES



Sliding Door with Side Panel / Shown as Right Hand (R)

Technical drawing

Sliding Door in Recess



Sliding Door with Side Panel

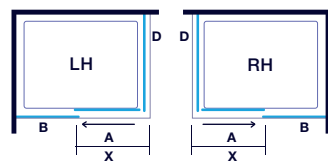

- A: Moving panel
- B: Fixed Panel
- D: Side Panel
- X: Door Opening

Size	X	A	B
1000	390	470	440
1100	430	530	480
1200	470	580	530
1300	530	630	580
1400	570	680	630
1500	570	680	730
1600	570	680	830
1700	570	680	930



Sliding Door

The 8 Series Sliding door is an impressive and highly engineered spacious enclosure with 8mm toughened safety glass, 1950mm high and smooth gliding action based on quick release double rollers for easy cleaning.

features

- » Height 1950mm
- » Translucent seals
- » Concealed fixings
- » Full length chrome magnetic strips
- » Easy clean double rollers
- » Chrome handle
- » Reversible
- » Wetroom compatible

Sliding Door				
Size	Tray Finish Adjustment	Code	Price £ Exc. VAT	Price £ Inc. VAT
1000	950-990	M88231	1087.95	1305.53
1100	1050-1090	M88251	1087.95	1305.53
1200	1150-1190	M88241	1087.95	1305.53
1300	1250-1290	M88240	1322.51	1587.01
1400	1350-1390	M88291	1375.37	1650.45
1500	1450-1490	M88261	1423.13	1707.75
1600	1550-1590	M88271	1440.68	1728.81
1700	1650-1690	M88281	1510.87	1813.04

Please add 20mm to tray finish adjustment when using a Side Panel.

Optional Side Panel				
Size	Tray Finish Adjustment	Code	Price £ Exc. VAT	Price £ Inc. VAT
700	670-690	M82201	607.58	729.09
760	730-750	M82210	607.58	729.09
800	770-790	M82211	607.58	729.09
900	870-890	M82221	644.17	773.00
1000	970-990	M82231	706.20	847.45

Sliding door can be paired with 2 optional Side Panels
For wetroom installation, please reduce tray finish adjustment by 20mm.

Optional Inline Panel				
Size	Tray Finish Adjustment	Code	Price £ Exc. VAT	Price £ Inc. VAT
150	130-150	M8P140	365.50	438.60
210	190-210	M8P2200	382.72	459.26

Inline panels can be fitted to either or both sides of Sliding Door - See page 144 for space solutions.



SCAN FOR MORE INFORMATION



Sliding Door in Recess



1 Door Quadrants

With fresh curved lines and designer chrome handles, the 1 Door Offset Quadrant exudes traditional style with a contemporary twist and a strong focus on expert engineering.

features

- » Height 1950mm
- » Concealed fixings
- » Chrome design symmetry handle
- » Reversible
- » Wetroom compatible
- » Translucent seals

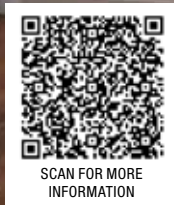

1 Door Offset Quadrant / Shown as Right Hand (R) 1400x800 size available

1 Door Quadrant

1 Door Quadrant

Size	Tray Finish Adjustment	Code	Price £ Exc. VAT	Price £ Inc. VAT
900 x 900	875-895	M83225	1385.43	1662.51
900 x 760	875-895 / 735-755	M83222	1569.21	1883.05
1000 x 800	975-995 / 775-795	M83233	1569.21	1883.05
1200 x 800	1175-1195 / 775-795	M83243	1582.88	1899.46
1200 x 900	1175-1195 / 875-895	M83241	1582.88	1899.46
1400 x 800	1375-1395 / 775-795	M83244	1587.52	1905.03

Please add 20mm to Adjustment when using a Side Panel.

MERLYN Dedicated Offset Quadrant Tray (1400x800)

Size	Code	Price £ Exc. VAT	Price £ Inc. VAT
1400 x 800	S148Q L or R	371.49	445.79

This tray is handed please choose L for left and R for right when ordering.
Please Note: The 1400x800mm tray is not an Touchstone Tray, it is a dedicated single skinned tray.
For wetroom installation, please reduce tray finish adjustment by 20mm.

Technical drawing

1 Door Offset Quadrant

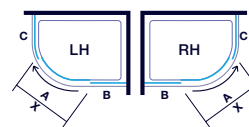

A: Moving Panel
B: Fixed Panel
C: Curved Panel
X: Door Opening

Size	X	B	C
900 x 760	420	465	275
1000 x 800	425	520	375
1200 x 800	425	520	575
1200 x 900	480	540	575
1400 x 800	425	520	775

1 Door Quadrant

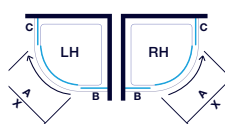

A: Moving Panel
B: Fixed Panel
C: Curved Fixed Panel
X: Door Opening

Size	X	B	C
900 x 900	480	540	275



2 Door Quadrants

With fresh curved lines and designer chrome handles, the 2 Door Quadrant exudes traditional style with a contemporary twist and a strong focus on expert engineering.

features

- » Height 1950mm
- » Translucent seals
- » Concealed fixings
- » Easy clean double rollers
- » Chrome design symmetry handle
- » Reversible
- » Wetroom compatible

8 | SERIES

SHOWER ENCLOSURES



2 Door Quadrant

2 Door Quadrant

Size	Tray Finish Adjustment	Code	Price £ Exc. VAT	Price £ Inc. VAT
800	775-795	M83211	1266.32	1519.58
900	875-895	M83221	1266.32	1519.58
1000	975-995	M83231	1554.22	1865.07

For wetroom installation, please reduce tray finish adjustment by 20mm.

Technical drawing

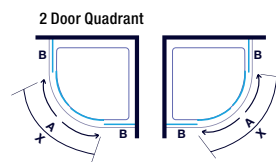

A: Moving Panels
 B: Fixed Panel
 X: Door Opening

All sizes to suit a 550mm Radius Tray.
 Extension profiles available.
 See page 143.

Size	X	A	B
800	410	385	220
900	540	385	320
1000	540	385	420

Infold Door

This door is the epitome of space saving solutions without compromising on the beautiful lines of the glass door. Pair this 1950mm high 8 Series door with the minimalist optional Side Panel and this enclosure becomes ideal for any corner setting.

features

- » Height 1950mm
- » Concealed fixings
- » Chrome design symmetry handle
- » Reversible
- » Wetroom compatible
- » Translucent seals



Infold Door with Side Panel / Shown as Right Hand (R)

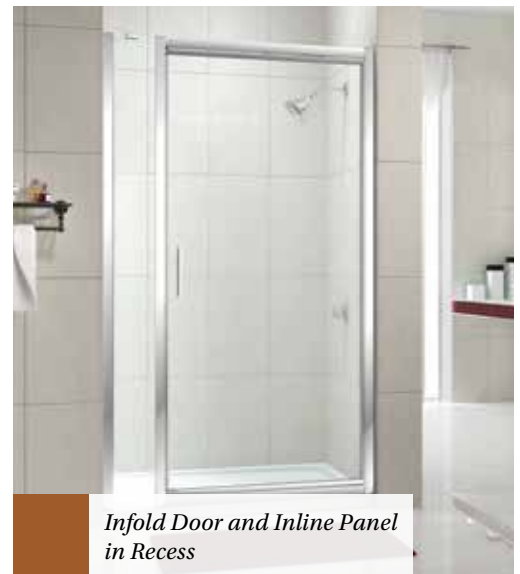

Infold Door and Inline Panel in Recess

Infold Door

Size	Tray Finish Adjustment	Code	Price £ Exc. VAT	Price £ Inc. VAT
700	650-690	M84401	1052.87	1263.44
760	710-750	M84410	1070.43	1284.51
800	750-790	M84411	1091.45	1309.74
900	850-890	M84421	1107.06	1328.48
1000	950-990	M84431	1205.03	1446.04

Please add 20mm to tray finish adjustment when using a Side Panel.

Optional Side Panel

Size	Tray Finish Adjustment	Code	Price £ Exc. VAT	Price £ Inc. VAT
700	670-690	M82201	607.58	729.09
760	730-750	M82210	607.58	729.09
800	770-790	M82211	607.58	729.09
900	870-890	M82221	644.17	773.00
1000	970-990	M82231	706.20	847.45

For wetroom installation, please reduce tray finish adjustment by 20mm.

Optional Inline Panel

Size	Tray Finish Adjustment	Code	Price £ Exc. VAT	Price £ Inc. VAT
150	130-150	M8P140	365.50	438.60
210	190-210	M8P2200	382.72	459.26

Inline Panels can be fitted to either or both sides of Infold Door - See page 144 for space solutions.

Technical drawing

Infold Door in Recess



Infold Door with side Panel

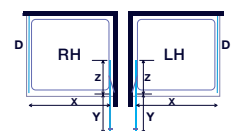

D: Side Panel

Y: Outside Door Swing

Z: Inside Door swing

X: Door Opening

Extension profiles available. See page 143.

Size	X	Y	Z
700	505	200	355
760	565	260	355
800	605	300	355
900	705	400	355
1000	805	500	355



Hinge Door

A practical choice for larger en suites or smaller bathrooms. The Hinge Door offers a highly specified and versatile option, making it suitable for a large range of spaces.

features

- » Height 1950mm
- » Concealed fixings
- » Extended length chrome design symmetry handle
- » Translucent seals
- » Wetroom compatible
- » Minimalist exposed glass edge
- » Signature hinges with internal flush fixings
- » Reversible
- » Double bales catch closing with definitive "Clunk" close



Hinge Door in Recess / Shown as Right Hand (R)



SCAN FOR MORE INFORMATION



Hinge Door with Side Panel

Hinge Door

Size	Tray Finish Adjustment	Code	Price £ Exc. VAT	Price £ Inc. VAT
700	650-690	M81201	993.87	1192.64
760	710-750	M81210	995.86	1195.03
800	750-790	M81211	995.86	1195.03
900	850-890	M81221	1102.51	1323.01
1000	950-990	M81231	1167.23	1400.68

Please add 20mm to tray finish adjustment when using a Side Panel.

Optional Side Panel

Size	Tray Finish Adjustment	Code	Price £ Exc. VAT	Price £ Inc. VAT
700	670-690	M82201	607.58	729.09
760	730-750	M82210	607.58	729.09
800	770-790	M82211	607.58	729.09
900	870-890	M82221	644.17	773.00
1000	970-990	M82231	706.20	847.45

For wetroom installation, please reduce tray finish adjustment by 20mm.

Optional Inline Panel

Size	Tray Finish Adjustment	Code	Price £ Exc. VAT	Price £ Inc. VAT
150	130-150	M8P140	365.50	438.60
210	190-210	M8P2200	382.72	459.26

Inline panels can be fitted to either or both sides of Hinge Door - See page 146 for space solutions. Please Note: Moving panel door must close onto the Side Panel.

Technical drawing

Hinge Door in Recess

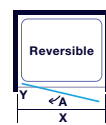

Hinge Door with Side Panel

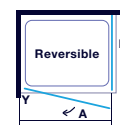

A: Moving Panel
D: Side Panel
Y: Door swing
X: Door Opening

Extension profiles available. See page 143.

Size	X	Y
700	550	550
760	610	610
800	650	650
900	750	750
1000	850	850



6^{MM}
GLASS
THICKNESS

LIFETIME
GUARANTEE

MERSHIELD™
STAYCLEAR

6 | series

Affordable quality

The 6 series range is the perfect choice if you are looking for a showering solution that is affordable yet incredibly stylish. The MERLYN trademark Mershield Stayclear™ and lifetime guarantee come as standard. This range delivers on style and functionality.



Easy clean push & release double rollers



Discreet inside handle and larger external handle for easy closing.

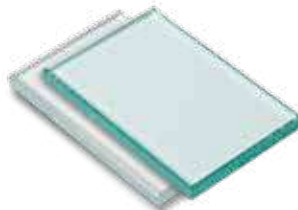

Stunningly crafted transparent glass



Technical drawing

Sliding Door in Recess

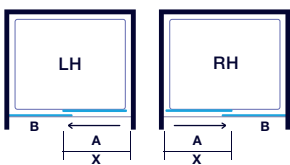

Sliding Door with side Panel

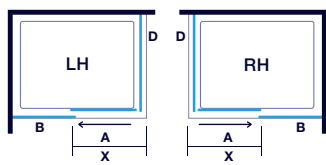

A: Moving Panel
 B: Fixed Panel
 D: Side Panel
 X: Door Opening

Extension profiles available. See page 143.

Size	X	A	B
1000	380	492	420
1100	430	542	470
1200	480	592	520
1400	580	692	620
1500	580	692	720
1600	580	692	820
1700	580	692	920



Sliding Door

The 6 Series Sliding Door has been enhanced with designer handles and quick release double rollers for easy access cleaning. With exceptionally smooth opening, this enclosure which stands at 1900mm high is affordable yet incredibly stylish.

features

- » Height 1900mm
- » Translucent seals
- » Full length chrome magnetic strips
- » Easy clean double rollers
- » Double handed
- » Can be used with 2 optional minimalist Side Panels
- » Reversible
- » Wetroom compatible

Sliding Door				
Size	Tray Finish Adjustment	Code	Price £ Exc. VAT	Price £ Inc. VAT
1000	950-1000	M68231	776.01	931.22
1100	1050-1100	M68251	776.01	931.22
1200	1150-1200	M68241	776.01	931.22
1400	1350-1400	M68291	952.52	1143.02
1500	1450-1500	M68261	1014.45	1217.34
1600	1550-1600	M68271	1071.75	1286.10
1700	1650-1700	M68281	1071.75	1286.10

*Order code for ordering shower enclosure and tray.
Please add 20mm to tray finish adjustment when using a Side Panel.

Optional Side Panel				
Size	Tray Finish Adjustment	Code	Price £ Exc. VAT	Price £ Inc. VAT
700	680-705	M62201N	441.77	530.13
760 / 800	745-790	M62211N	397.58	477.09
900	875-900	M62221N	423.07	507.68
1000	975-1000	M62231N	468.96	562.75

Sliding door can be paired with 2 optional Side Panels
For wetroom installation, please reduce tray finish adjustment by 20mm.

Optional Inline Panel				
Size	Tray Finish Adjustment	Code	Price £ Exc. VAT	Price £ Inc. VAT
140	115-140	M6I125	346.57	415.89
215	190-215	M6I200	363.97	436.76

Inline panels can be fitted to either or both sides of Sliding Door. See page 145 for space solutions.



SCAN FOR MORE INFORMATION



Sliding Door in Recess

Quadrants

The 6 Series Quadrants have it all – 1900mm high with a beautifully curved chrome frame, 6mm toughened glass, designer handles and quick release double rollers for easy access to clean – stylish yet very affordable.

features

- » Height 1900mm
- » Translucent seals
- » Easy clean double rollers
- » Double handed
- » Reversible
- » Wetroom compatible

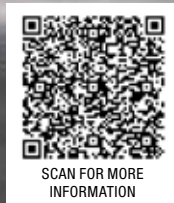

1 Door Quadrant / Shown as Left Hand (L)



2 Door Quadrant

1 Door Quadrant

Size	Tray Finish Adjustment	Code	Price £ Exc. VAT	Price £ Inc. VAT
900 x 900	875-900	M63225	1004.51	1205.41
900 x 760	875-900 / 735-760	M63222	1115.60	1338.72
1000 x 800	975-1000 / 775-800	M63233	1325.64	1590.77
1200 x 800	1175-1200 / 775-800	M63243	1323.44	1588.12
1200 x 900	1175-1200 / 875-900	M63241	1325.60	1590.72

For wetroom installation, please reduce tray finish adjustment by 20mm.

2 Door Quadrant

Size	Tray Finish Adjustment	Code	Price £ Exc. VAT	Price £ Inc. VAT
800	775-800	M63211	849.44	1019.33
900	875-900	M63221	849.44	1019.33
1000	975-1000	M63231	1068.55	1282.26

For wetroom installation, please reduce tray finish adjustment by 20mm.

Technical drawing

1 Door Quadrant

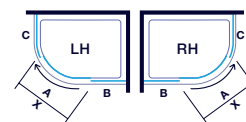

A: Moving Panel
B: Fixed Panel
C: Fixed Panel
X: Door Opening
All sizes to suit a 550mm Radius Tray. Extension profiles available. See page 143.

Size	X	B	C
900 x 760	405	460	280
900 x 900	480	540	250
1000 x 800	430	495	380
1200 x 800	430	495	580
1200 x 900	480	540	580

2 Door Quadrant

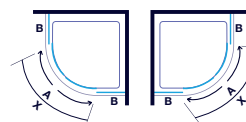

Size	X	B
800	375	225
900	540	325
1000	540	425

A: Moving Panel
B: Fixed Panel
X: Door Opening



Pivot Door

The 6 Series Pivot Door has been enhanced with designer handles and quick release double rollers for easy access cleaning. With exceptionally smooth opening, this enclosure which stands at 1900mm high is affordable yet incredibly stylish.

features

- » Height 1900mm
- » Translucent seals
- » Full length chrome
- » Magnetic strips
- » Easy clean double rollers
- » Double handed
- » Can be used with 2 optional minimalist Side Panels
- » Reversible
- » Wetroom compatible

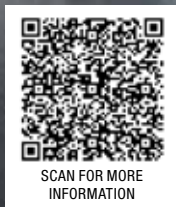

SCAN FOR MORE INFORMATION

Pivot Door with Side Panel / Shown as Left Hand (L)

Pivot Door

Size	Tray Finish Adjustment	Code	Price £ Exc. VAT	Price £ Inc. VAT
700	670-720	M61201N	559.01	670.82
760/800	740-790	M61211N	629.37	755.25
900	850-900	M61221N	659.79	791.75
1000	950-1000	M61231N	695.50	834.60

Please add 10mm to tray finish adjustment when using a Side Panel.

Optional Side Panel

Size	Tray Finish Adjustment	Code	Price £ Exc. VAT	Price £ Inc. VAT
700	680-705	M62201N	441.77	530.13
760 / 800	745-790	M62211N	397.58	477.09
900	875-900	M62221N	423.07	507.68
1000	975-1000	M62231N	468.96	562.75

Sliding door can be paired with 2 optional Side Panels. For wetroom installation, please reduce tray finish adjustment by 20mm.

Optional Inline Panel

Size	Tray Finish Adjustment	Code	Price £ Exc. VAT	Price £ Inc. VAT
700	680-705	M62201N	441.77	530.13
760 / 800	745-790	M62211N	397.58	477.09

Inline panels can be fitted to either or both sides of Sliding Door. See page 145 for space solutions.

Technical drawing

Pivot Door in Recess

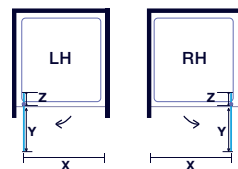

Pivot Door with Side Panel

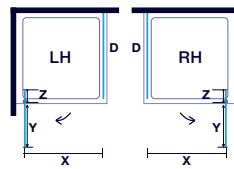

Size	X	Y	Z
700	410	410	120
760 / 800	480	480	120
900	590	590	120
1000	690	690	120

X: Door Opening

Y: Outside Door Swing

Z: Inside Door Swing

Note: Side Panel is 6mm glass

Extension profiles available. See page 143.

Bifold Door

Where space is at a premium the 6 Series Bifold is the ultimate solution. This new version of a classic shape, offers a sleek frameless design with a discreet chrome hinge detail.

features

- » Height 1900mm
- » Discreet chrome bifold hinge
- » Sleek frameless door design
- » Reversible
- » Wetroom compatible

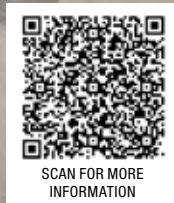

Bifold Door with Side Panel / Shown as Right Hand (R)



Bifold Door in Recess

Bifold Door

Size	Tray Finish Adjustment	Code	Price £ Exc. VAT	Price £ Inc. VAT
700	670-720	M67201N	867.91	1041.49
760 / 800	740-790	M67211N	867.91	1041.49
900	850-900	M67221N	930.28	1116.34
1000	950-1000	M67231N	978.41	1174.09

Can be used with 2 optional minimalist Side Panels.
Please add 10mm to tray finish adjustment when using a Side Panel.

Optional Side Panel

Size	Tray Finish Adjustment	Code	Price £ Exc. VAT	Price £ Inc. VAT
700	680-705	M62201N	441.77	530.13
760 / 800	745-790	M62211N	397.58	477.09
900	875-900	M62221N	423.07	507.68
1000	975-1000	M62231N	468.96	562.75

For wetroom installation, please reduce tray finish adjustment by 20mm.

Optional Inline Panel

Size	Tray Finish Adjustment	Code	Price £ Exc. VAT	Price £ Inc. VAT
140	115-140	M6I125	346.57	415.89
215	190-215	M6I200	363.97	436.76

Inline Panels can be fitted to either or both sides of Bifold Door. See page 145 for space solutions.

Technical drawing

Bifold Door in Recess

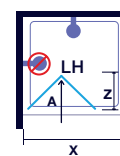

Bifold Door with Side Panel

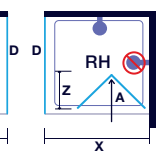
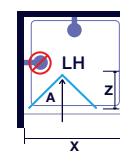
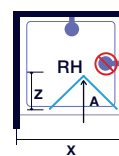

A: Moving Panel
X: Door Opening
Z: Width of panel when folded

Extension profiles available. See page 143.

Size	X	Z
700	420	295
760 / 800	490	330
900	600	385
1000	650	430



Corner Door

The 6 Series Corner door is a functional and contemporary enclosure. It is the perfect solution for bijoux en suites or awkward spaces as the doors slide back within the confines of the shower itself.

features

- » Height 1900mm
- » Translucent seals
- » Easy clean double rollers
- » Double handed
- » Double sliding doors
- » Reversible
- » Wetroom compatible



Corner Door with side Panel

Corner Door

Size	Tray Finish Adjustment	Code	Price £ Exc. VAT	Price £ Inc. VAT
800	775-800	M65211	973.71	1168.45
900	875-900	M65221	1071.63	1285.95

*Code for ordering shower enclosure with tray.
For wetroom installation, please reduce tray finish adjustment by 20mm.

Technical drawing

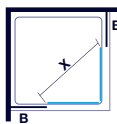

Size	X	B
800	395	310
900	465	360

X: Door Opening
B: Fixed Panel
Extension profiles available. See page 143.



8^{MM}
GLASS
THICKNESS

LIFETIME
GUARANTEE

MERSHIELD[™]
STAYCLEAR

MERLYN[™] | BLACK

Fuse aesthetics & functionality

MERLYN Black has firmly established itself as a real alternative to Chrome. A favourite among Interior designers and customers seeking a modern look. Transform your bathroom space and make it the statement piece you desire.

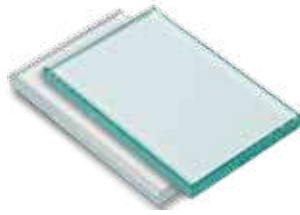

*Stunningly crafted
transparent glass*



Beautifully crafted materials



Sliding Door with Side Panel / Shown as Left Hand (L)

Technical drawing

Sliding Door in Recess



Size	X	B
1200	468	560
1400	568	660
1500	568	760
1700	568	960

Sliding Door with Side Panel

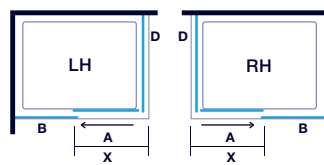

Size	X	B
1200	450	560
1400	550	660
1500	550	760
1700	550	960

- A: Moving Panel
- B: Fixed Panel
- D: Side Panel
- X: Door Opening



Sliding Door

The MERLYN Black Sliding Door brings with it the smoothest rolling action possible in 8mm glass. With stunning designer features and its sleek, minimal matte black frame, this enclosure symbolises style that will stand out in your bathroom space.

features

- » Height 2000mm
- » Black seals
- » Concealed fittings
- » Smooth action rollers
- » Reversible
- » Anodised aluminium matte black finish - more durable than powder coating
- » Wetroom compatible

Sliding Door

Size	Adjustment in Recess	Adjustment with Side Panel	Code	Price £ Exc. VAT	Price £ Inc. VAT
1200	1150 - 1190	1140-1165	BLKFSL1200H	1091.10	1309.32
1400	1350 - 1390	1340-1365	BLKFSL1400H	1257.59	1509.11
1500	1450 - 1490	1440-1465	BLKFSL1500H	1316.27	1579.52
1700	1650 - 1690	1640-1665	BLKFSL1700H	1436.04	1723.25

*Please allow 5mm - 15mm step-in on the tray. See table below for waste cap options.

Optional Side Panel

Size	Adjustment	Code	Price £ Exc. VAT	Price £ Inc. VAT
800	760 - 785	BLKFSP800	571.30	685.56
900	860 - 885	BLKFSP900	606.04	727.25

Additional Options

Size	Add-On	Code	Price £ Exc. VAT	Price £ Inc. VAT
2000	Sliding Door Extension Profile	BLKFSLEXT	111.33	133.59
-	White Waste Cap	DWASCAPWHT	17.12	20.54

MERLYN Black extension profile: extra 20mm. Extension Profile is matte black. White Waste Cap is for Touchstone trays only. Waste cap comes in chrome as standard.

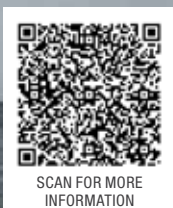

SCAN FOR MORE INFORMATION

The black colour layer is not applied to the surface like paint or plating, but is fully integrated with the underlying aluminium substrate, so it cannot chip or peel.



Sliding Door in Recess



Hinge and Inline with Side Panel / Shown as Right Hand (R)

Technical drawing

Hinge and Inline Door a Recess

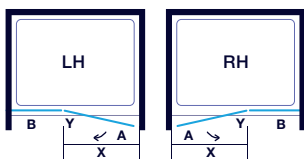

Hinge and Inline Door with Side Panel

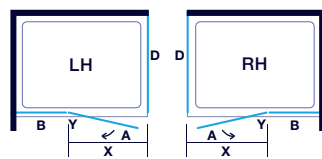

- A: Moving Panel
- B: Fixed Panel
- D: Side Panel
- Y: Door Swing
- X: Door Opening
- + Sizes indicate opening when fitted with side panel

Size	X	Y	B
900	490	520	250
900+	530	560	250
1000	540	570	300
1000+	580	610	300
1200	590	620	450
1200+	630	660	450
1400	590	620	670
1400+	630	660	670



Hinge and Inline

This new frameless enclosure fuses style and elegance with practical functionality. The MERLYN Black Hinge & Inline enclosure creates a fabulous contrast feature within your bathroom that will be the envy of all who visit.

features

- » Height 2000mm
- » Black seals
- » Luxury metal handle
- » Sleek designer bracing bar
- » Anodised aluminium matte black finish - more durable than powder coating
- » Reversible

Hinge and Inline in Recess (+ codes can only be used with Side Panels)

Size	Adjustment	Code	Price £ Exc. VAT	Price £ Inc. VAT
900	860 - 900	BLKH900REC	1275.56	1530.67
900+	900 - 940	BLKH900SP	1275.56	1530.67
1000	960 - 1000	BLKH1000REC	1275.56	1530.67
1000+	1000 - 1040	BLKH1000SP	1275.56	1530.67
1200	1160 - 1200	BLKH1200RECH	1382.15	1658.58
1200+	1200 - 1240	BLKH1200SP	1382.15	1658.58
1400	1360 - 1400	BLKH1400RECH	1735.46	2082.55
1400+	1400 - 1440	BLKH1400SP	1735.46	2082.55

Hinge and Inline with Side Panel (+ codes can only be used with Side Panels)

Size	Adjustment	Code	Price £ Exc. VAT	Price £ Inc. VAT
900+	870 - 890	BLKH900SP	1275.56	1530.67
1000+	970 - 990	BLKH1000SP	1275.56	1530.67
1200+	1170 - 1190	BLKH1200SPH	1382.15	1658.58
1400+	1370 - 1390	BLKH1400SPH	1735.46	2082.55

Optional Side Panel to match + sizes only

Size	Adjustment	Code	Price £ Exc. VAT	Price £ Inc. VAT
760	730 - 750	BLKHSP760	570.10	684.12
800	770 - 790	BLKHSP800	570.10	684.12
900	870 - 890	BLKHSP900	570.10	684.12

Additional Options

Size	Add-On	Code	Price £ Exc. VAT	Price £ Inc. VAT
2000	Hinge & Inline Extension Profile	BLKHEXT	111.33	133.59
-	White Waste Cap	DWASCAPWHT	17.12	20.54

MERLYN Black extension profile: extra 20mm. Extension Profile is matte black. White Waste Cap is for Touchstone trays only. Waste cap comes in chrome as standard.

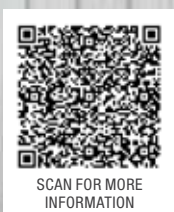

SCAN FOR MORE INFORMATION



Stabilising Bar



8^{MM}
GLASS
THICKNESS

LIFETIME
GUARANTEE

MERSHIELD™
STAYCLEAR

IONIC | Essence Frameless

Style, seamless precision

Ionic Essence is truly unique in its appearance with its fusion of style and precision engineering. We have spent a great deal of time developing this stylish range that stays true to the basic Ionic principle — built to last.



Stunningly crafted transparent glass



Double handles



Designer handles



Designer hinge with concealed pivot



Sliding Door in Recess / Shown as Left Hand (L)

Technical drawing

Sliding Door in Recess



A: Moving Panel
B: Fixed Panel
X: Door Opening

Size	X	B
1000	365	465
1100	415	515
1200	465	565
1400	565	665
1700	565	965

Sliding Door with Side Panel

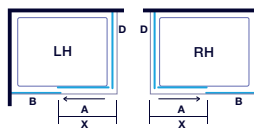

A: Moving Panel
B: Fixed Panel
D: Side Panel
X: Door Opening

Size	X	B
1000	350	465
1100	400	515
1200	450	565
1400	550	665
1700	550	965



Sliding Door

The Ionic Essence Frameless Sliding Door is offered in a variety of size, ranging from 1000mm to 1700mm, making it an excellent fit for shower spaces of medium to large dimensions. Featuring a frameless design, this minimalist door helps create a real sense of space in your bathroom.

features

- » Height 2000mm
- » Concealed fixing
- » Reversible
- » Smooth action extra strong rollers
- » Stunning frameless design
- » Discreet deflection seal on luna rail for increased water retention
- » Minimalist designer rail with concealed rollers both inside and outside
- » Chrome double handle

Sliding Door

Size	Adjustment in Recess	Adjustment with Side Panel	Code	Price £ Exc. VAT	Price £ Inc. VAT
1000	950-990	940 - 965	A0104A0	1154.28	1385.14
1100	1050-1090	1040-1065	A0104B0	1154.28	1385.14
1200	1150-1190	1140 - 1165	A0104IH	1154.28	1385.14
1400	1350-1390	1340 - 1365	A0104DH	1224.33	1469.19
1700	1650-1690	1640 - 1665	A0104HH	1399.48	1679.37

Optional Side Panel

Size	Adjustment	Code	Price £ Exc. VAT	Price £ Inc. VAT
800	760-785	A0107I0	628.79	754.55
900	860-885	A0107J0	663.87	796.64



SCAN FOR MORE INFORMATION



Sliding Door with Side Panel



1 Door Offset Quadrant / Shown as Left Hand (L)

Technical drawing

1 Door Quadrant

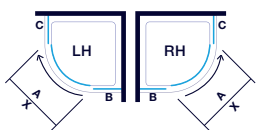

A: moving Panel
 B: Fixed Panel
 C: Fixed Panel
 X: Door Opening

Size	X	B	C
900	475	550	290

1 Door Offset Quadrant

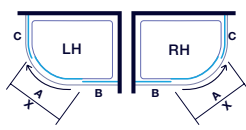

A: moving Panel
 B: Fixed Panel
 C: Curved Fixed Panel
 X: Door Opening

Size	X	B	C
1200 x 900	475	550	590



1 Door Quadrants

With an extra smooth roller action, the Ionic Essence Frameless Quadrant Door combines clean lines and subtle curves, for a spacious showering space.

features

- » Height 2000mm
- » Concealed fixing
- » Smooth action extra strong rollers
- » Chrome double handle
- » Stunning frameless design
- » Minimalist designer rail with concealed rollers both inside and out
- » Discreet deflector seal on luna rail for increased water retention
- » Extra strong rollers with additional guide to added smoothness.

1 Door Quadrant

Size	Adjustment	Code	Price £ Exc. VAT	Price £ Inc. VAT
900 x 900	860-885	A0101MH L	1574.64	1889.56
900 x 900	860-885	A0101NH R	1574.64	1889.56
1200 x 900	860-885 / 1160-1185	A0101KH L	1749.81	2099.77
1200 x 900	860-885 / 1160-1185	A0101LH R	1749.81	2099.77



SCAN FOR MORE INFORMATION



1 Door Quadrant

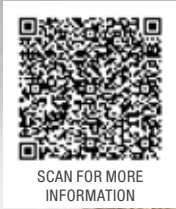

Hinge and Inline in Recess / Shown as Right Hand (R)

Hinge & Inline Door in Recess

Size	Adjustment	Code	Price £ Exc. VAT	Price £ Inc. VAT
760	720-760	A0111FO	994.90	1193.88
800	760-800	A0111CO	994.90	1193.88
800+	800-840	A0111MO	994.90	1193.88
900	860-900	A0111DO	994.90	1193.88
900+	900-940	A0111NO	994.90	1193.88
1000	960-1000	A0111EO	1047.45	1256.95
1000+	1000-1040	A0111OO	1047.45	1256.95
1100	1060-1100	A0111JH	1108.76	1330.52
1100+	1100-1140	A0111JF	1108.76	1330.52
1200	1160-1200	A0111GH	1108.76	1330.52
1200+	1200-1240	A0111GF	1108.76	1330.52
1400	1360-1400	A0111HH	1189.35	1427.22
1400+	1400-1440	A0111HF	1189.35	1427.22
1500	1460-1500	A0111KH	1276.87	1532.24
1500+	1500-1540	A0111KF	1276.87	1532.24

Size	X	Y	B
760	440	460	160
800	440	460	200
800+	480	500	200
900	490	510	250
900+	530	550	250
1000	540	560	300
1000+	580	600	300
1100	590	610	350
1100+	630	650	350
1200	590	610	450
1200+	630	650	450
1400	590	610	650
1400+	630	650	650
1500	590	610	750
1500+	630	650	750

Technical drawing

Hinge and Inline Door in Recess

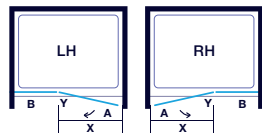

A: Moving Panel Y: Door Swing
 B: Fixed Panel X: Door Opening

Please note : Side panels should only be used with + sizes (not standard sizes).



Hinge & Inline Panel in Recess and with Side Panel

Offered in sizes ranging from 760mm to 1500mm, the Ionic Essence Frameless Hinge and Inline provides a tailored solution for your needs. With its elegant frameless design, this door adds a touch of refinement to any bathroom style.

features

- » Height 2000mm
- » Concealed fixings
- » Solid chrome double handle symmetrical to hinges
- » Solid designer hinge with concealed pivot point
- » Reversible
- » Stunning frameless design



Hinge and Inline with Side Panel / Shown as Right Hand (R)

Hinge & Inline Door with Side Panel

Size	Adjustment	Code	Price £ Exc. VAT	Price £ Inc. VAT
800+	770-790	A0111M0	994.90	1193.88
900+	870-890	A0111N0	994.90	1193.88
1000+	970-990	A0111O0	1047.45	1256.95
1100+	1070-1090	A0111JF	1108.76	1330.52
1200+	1170-1190	A0111GF	1108.76	1330.52
1400+	1370-1390	A0111HF	1189.35	1427.22
1500+	1470-1490	A0111KF	1276.87	1532.24

Optional Side Panel

Size	Adjustment	Code	Price £ Exc. VAT	Price £ Inc. VAT
800	750-790	A0107G0	576.22	691.47
900	850-890	A0107H0	611.33	733.59

Technical drawing

Hinge and Inline Door with Side Panel

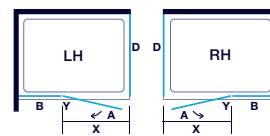

- A: Moving Panel
- B: Fixed Panel
- D: Side Panel
- Y: Door Swing
- X: Door Opening

Please note : Side panels should only be used with + sizes (not standard sizes).

Size	X	Y	B
800+	480	500	200
900+	530	550	250
1000+	580	600	300
1100+	630	650	350
1200+	630	650	450
1400+	630	650	650
1500+	630	650	750





8_{MM}
GLASS
THICKNESS

LIFETIME
GUARANTEE

MERSHIELD™
STAYCLEAR

IONIC | Essence Framed

Precision engineering

Precision engineered to suit every bathroom space. Colour matched chrome magnetic seals and concealed fittings to ensure it looks great all around and quick release double rollers which makes it hassle-free to clean.



Easy clean push & release double rollers



Sliding Door with Side Panel / Shown as Right Hand (R)

Technical drawing

Sliding Door in Recess



Sliding Door with Side Panel

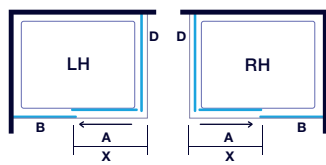

- A: Moving Panel
- B: Fixed Panel
- D: Side Panel
- X: Door Opening

Size	X	B
1000	360	380
1100	410	430
1200	460	480
1400	560	580
1700	560	880



Sliding Door

Exuding both style and seamless motion, the Ionic Essence Framed Sliding Door will add a focal point to any bathroom aesthetic.

features

- » Height 1900mm
- » Concealed fixing
- » Reversible
- » Smooth action extra strong rollers
- » Easy clean quick release rollers
- » Chrome finish including top cover caps
- » Chrome magnetic strips

Sliding Door

Size	Adjustment	Code	Price £ Exc. VAT	Price £ Inc. VAT
1000	930-990	DWH04A0	795.51	954.62
1100	1030-1090	DWH04B1	795.51	954.62
1200	1130-1190	DWH04C0	795.51	954.62
1400	1330-1390	DWH04DH	919.19	1103.03
1700	1630-1690	DWH04EH	1061.25	1273.50

Optional Side Panel

Size	Adjustment	Code	Price £ Exc. VAT	Price £ Inc. VAT
760	720-750	DWH07B0	370.56	444.67
800	760-790	DWH07D0	370.56	444.67
900	860-890	DWH07E0	436.91	524.29



SCAN FOR MORE INFORMATION



Sliding Door in Recess

1 Door Quadrant

The Ionic Essence 1 Door Quadrant offers an optimal showering solution, suitable for smaller bathrooms where a side entry is more practical.

features

- » Height 1900mm
- » Concealed fixings
- » Space saving solution
- » Chrome finish including top cover caps



Bifold Door with Side Panel / Shown as Right Hand (R)

1 Door Quadrant

1 Door Quadrant

Size	Adjustment	Code	Price £ Exc. VAT	Price £ Inc. VAT
900	850-880	DWH03DH	1101.09	1321.31
1000 x 800	750-780 / 950-980	DWH03BH	1140.95	1369.14
1200 x 800	750-780 / 1150-1180	DWH03CH	1140.95	1369.14
1200 x 900	850-880 / 1150-1180	DWH03EH	1140.95	1369.14

Technical drawing

1 Door Quadrant

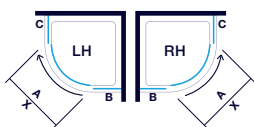

Size	X	B	C
900	450	460	330

X: Door Opening
A: Moving Panel
B: Fixed Panel
C: Fixed Panel

1 Door Offset Quadrant

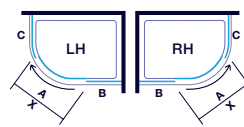

Size	X	B	C
1000 x 800	394	430	430
1200 x 800	394	430	630
1200 x 900	450	460	630

X: Door Opening
A: Moving Panel
B: Fixed Panel
C: Curved Fixed Panel



2 Door Quadrant

The Ionic Essence Framed 2 Door Quadrant is an excellent choice for maximizing corner space utilisation, featuring two smooth sliding doors.

features

- » Height 1900mm
- » Concealed fixings
- » Space saving solution
- » Chrome finish including top cover caps
- » Reversible

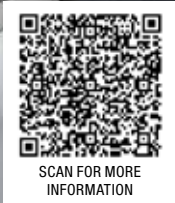

SCAN FOR MORE INFORMATION

2 Door Quadrant

2 Door Quadrant				
Size	Adjustment	Code	Price £ Exc. VAT	Price £ Inc. VAT
800	750-780	DWH02A0	994.74	1193.69
900	850-880	DWH02B0	994.74	1193.69
1000	950-980	DWH02CH	1127.61	1353.13

Technical drawing

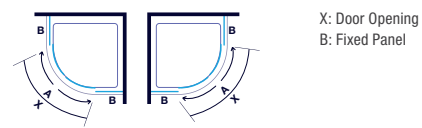

Size	X	B
800	370	180
900	520	280
1000	520	380

6^{MM}
GLASS
THICKNESS

LIFETIME
GUARANTEE

MERSHIELD[®]
STAYCLEAR

Bifold Door

Incorporating both style and functionality, the Ionic Essence Framed Bifold Door maximizes the usable space. It serves as an ideal solution for bathrooms of all sizes.

features

- » Height 1900mm
- » Concealed fixings
- » Space saving solution
- » Chrome finish including top cover caps
- » Reversible



Bifold Door with Side Panel / Shown as Right Hand (R)



Bifold Door in Recess

Bifold Door

Size	Adjustment	Code	Price £ Exc. VAT	Price £ Inc. VAT
760	690-750	DWH00B0	763.17	915.81
800	730-790	DWH00C0	763.17	915.81
900	830-890	DWH00D0	806.09	967.31
1000	930-990	DWH00E0	917.96	1101.55

Optional Side Panel

Size	Adjustment	Code	Price £ Exc. VAT	Price £ Inc. VAT
760	720-750	DWH07B0	370.56	444.67
800	760-790	DWH07D0	370.56	444.67
900	860-890	DWH07E0	436.91	524.29

Technical drawing

Bifold Door in Recess

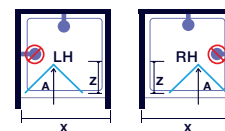

Bifold Door with Side Panel

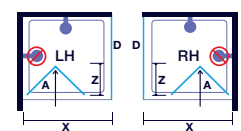

- A: Moving Panel
- D: Side Panel
- X: Door Opening
- Z: Width of panel when folded

Extension profiles available. See page 143.

Size	X	Z
760	436	335
800	476	355
900	576	405
1000	626	455

Pivot Door

Whether used in conjunction with a side panel or set in a recess, the Ionic Essence Framed Pivot Door offers an elegant yet practical showering solution.

features

- » Height 1900mm
- » Concealed fixings
- » Chrome finish including top cover caps
- » Reversible
- » Coloured matching chrome magnetic seals
- » Solid "Clunk" close

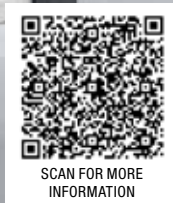

Pivot Door with Side Panel / Shown as Right Hand (R)



Pivot Door in Recess

Pivot Door

Size	Adjustment	Code	Price £ Exc. VAT	Price £ Inc. VAT
760	690-750	DWH06B0	662.81	795.37
800	730-790	DWH06D0	702.65	843.18
900	830-890	DWH06E0	729.14	874.97

Optional Side Panel

Size	Adjustment	Code	Price £ Exc. VAT	Price £ Inc. VAT
760	720-750	DWH07B0	370.56	444.67
800	760-790	DWH07D0	370.56	444.67
900	860-890	DWH07E0	436.91	524.29

Technical drawing

Pivot Door in Recess

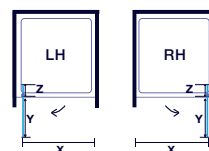

Pivot Door with Side Panel

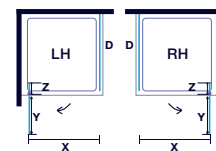

D: Side Panel
Y: Outside Door Swing
X: Door Opening
Z: Inside Door Swing

Size	X	Y	Z
760	433	415	180
800	473	455	180
900	573	555	180





6^{MM}
GLASS
THICKNESS

LIFETIME
GUARANTEE

MERSHIELD[™]
STAYCLEAR

IONIC | Express

Easy-fit system

Express by name, express by nature. With an innovative easy-fit system, the Ionic Express range has been designed with you in mind.

EASY-FIT STEPS



Step one: Slot & connect frame in place.



Step two: Slide mechanism to secure profile at each corner.



Step three: Quarter turn to lock wall & upright profiles in place, without the need for drilling through aluminium.



Sliding Door with Side Panel / Shown as Left Hand (L)

Technical drawing

Sliding Door in Recess

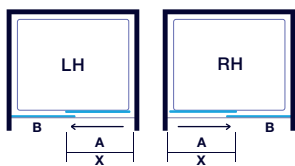

Sliding Door with Side Panel

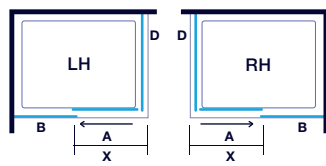

- A: Moving Panel
- B: Fixed Panel
- D: Side Panel
- X: Door Opening

Size	X	B
1000	380	433
1100	430	483
1200	480	533
1400	580	633
1500	580	733
1600	580	833
1700	580	933



Sliding Door

Offering a range of sizes from 1000mm to 1700mm, the easy to fit Ionic Express Sliding Door provides you with the flexibility to create an ideal showering area for your bathroom.

features

- » Height 1900mm
- » Easy-fit system
- » Reversible
- » Smooth action extra strong rollers
- » Concealed fixing
- » Easy clean quick release rollers
- » Double fin seal for increased water retention
- » Rollers pre-assembled on door

Sliding Door

Size	Adjustment	Code	Price £ Exc. VAT	Price £ Inc. VAT
1000	950-990	A0304A0	643.50	772.20
1100	1050-1090	A0304B0	643.50	772.20
1200	1150-1190	A0304C0	643.50	772.20
1400	1350-1390	A0304DH	827.87	993.44
1500	1450-1490	A0304GH	881.27	1057.52
1600	1550-1590	A0304EH	901.60	1081.92
1700	1650-1690	A0304HH	912.72	1095.26

Optional Side Panel

Size	Adjustment	Code	Price £ Exc. VAT	Price £ Inc. VAT
700	650-670	A0307A0	396.36	475.63
760	710-730	A0307B0	396.36	475.63
800	750-770	A0307D0	396.36	475.63
900	850-870	A0307E0	437.00	524.40

Optional Inline Panel

Size	Adjustment	Code	Price £ Exc. VAT	Price £ Inc. VAT
150	130-150	A0315B0	330.05	396.06
210	190-210	A0315C0	330.05	396.06
490 (New)	470-490	A0315D0	385.87	463.05

For Inline Panel size calculations please see page 146.
Please Note: Sliding Door can be paired with 2 additional Side Panels.



SCAN FOR MORE INFORMATION



Sliding Door in Recess



Sliding Door with Side Panel / Shown as Left Hand (L)

Technical drawing

Sliding Door in Recess

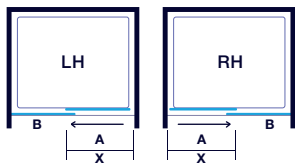

Sliding Door with Side Panel

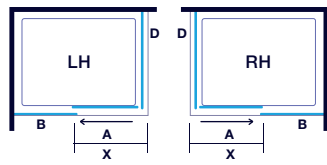

- A: Moving Panel
- B: Fixed Panel
- D: Side Panel
- X: Door Opening

Size	X	B
1000	376	433
1200	476	533
1400	576	633
1700	576	933



Sliding Door Low Level Access

Create a fully inclusive bathroom environment with the low level access sliding door, thanks to its minimal bottom rail. Available in the same sizes as the standard Ionic Express Sliding Door.

features

- » Height 1900mm
- » Easy-fit system
- » Door Handed
- » No bottom rollers - bottom glide system instead
- » Push-button door release for easy clean
- » Rollers pre-assembled on the top of the door
- » Allows easy access for users on both tray and wetroom situations - no more stepping required.
- » Adjustable fin seal for increased water retention, allowing the seal to always be flush with the floor/ tray

Sliding Door

Size	Adjustment in Recess	Adjustment with Side Panel	Code	Price £ Exc. VAT	Price £ Inc. VAT
1000	950-990	960-1000	A0303A0 L	739.88	887.86
1000	950-990	960-1000	A0303B0 R	739.88	887.86
1200	1150-1190	1160-1200	A0303G0 L	739.88	887.86
1200	1150-1190	1160-1200	A0303H0 R	739.88	887.86
1400	1350-1390	1360-1400	A0303LH L	952.38	1142.86
1400	1350-1390	1360-1400	A0303MH R	952.38	1142.86
1700	1650-1690	1660-1700	A0303SH L	1050.11	1260.13
1700	1650-1690	1660-1700	A0303TH R	1050.11	1260.13

Optional Side Panel

Size	Adjustment	Code	Price £ Exc. VAT	Price £ Inc. VAT
700	650-670	A0307A0	396.36	475.63
760	710-730	A0307B0	396.36	475.63
800	750-770	A0307D0	396.36	475.63
900	850-870	A0307E0	437.00	524.40

Optional Inline Panel

Size	Adjustment	Code	Price £ Exc. VAT	Price £ Inc. VAT
150	130-150	A0315B0	330.05	396.06
210	190-210	A0315C0	330.05	396.06
490	470-490	A0315D0	385.87	463.05



SCAN FOR MORE INFORMATION



Sliding Door in Recess

6^{MM}
GLASS
THICKNESS

LIFETIME
GUARANTEE

MERSHIELD
STAYCLEAR

1 Door Quadrant

The Ionic Express 1 Door Quadrant offers an efficient space-saving solution for your bathroom. It features quick release rollers for ease of cleaning.

features

- » Height 1900mm
- » Easy-fit system
- » Reversible
- » Concealed fixing
- » Smooth action extra strong rollers
- » Double fin seal for increased water retention
- » Easy clean quick release rollers
- » Rollers pre-assembled on door

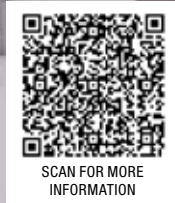

1 Door Quadrant / Shown as Left Hand (L)

1 Door Quadrant

Size	Adjustment	Code	Price £ Exc. VAT	Price £ Inc. VAT
900	855-875	A0301B0	901.60	1081.92

Technical drawing

1 Door Quadrant

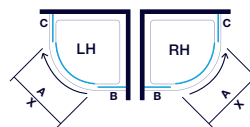

A: Moving Panel
B: Fixed Panel
C: Fixed Panel
X: Door Opening

Size	X	B	C
900	460	526	321

2 Door Quadrant

The Ionic Express 2 Door Quadrant is designed with two sliding doors that glide smoothly, offering convenient access to the shower space.

features

- » Height 1900mm
- » Easy-fit system
- » Reversible
- » Concealed fixing
- » Smooth action extra strong rollers
- » Double fin seal for increased water retention
- » Easy clean quick release rollers
- » Rollers pre-assembled on door tray



2 Door Offset Quadrant



2 Door Quadrant

2 Door Quadrant

Size	Adjustment	Code	Price £ Exc. VAT	Price £ Inc. VAT
800	755-775	A0302A0	994.90	1193.88
900	855-875	A0302B0	994.90	1193.88

20mm Adjustment per wall profile.

2 Door Offset Quadrant

Size	Adjustment	Code	Price £ Exc. VAT	Price £ Inc. VAT
900 x 760	855-875 / 715-735	A0302C0	827.87	993.44
1000 x 800	955-975 / 755-775	A0302D0	901.60	1081.92
1200 x 800	1155-1175 / 755-775	A0302HH	1045.49	1254.59
1200 x 900	1155-1175 / 855-875	A0302IH	1078.56	1294.27

Technical drawing

2 Door Quadrant

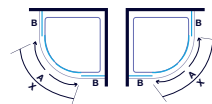

A: Moving Panel
B: Fixed Panel
X: Door Opening

Size	X	B
800	390	221
900	540	321

2 Door Offset Quadrant

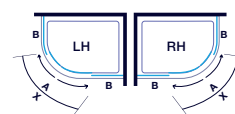

A: Moving Panel
B: Fixed Panel
X: Door Opening

Size	X	B	C
900 x 760	430	321	181
1000 x 800	465	421	221
1200 x 800	465	621	221
1200 x 900	540	621	321

Bifold Door

The Ionic Express Bifold Door is the perfect solution for smaller bathrooms with limited space. The inward opening makes it easier to access the shower.

features

- » Height 1900mm
- » Easy-fit system
- » Reversible
- » Concealed fixings
- » Discreet chrome bifold hinge
- » 20mm adjustment per wall profile



Bifold Door with Side Panel / Shown as Left Hand (L)



Bifold Door Shown in Recess

Bifold Door

Size	Adjustment	Code	Price £ Exc. VAT	Price £ Inc. VAT
760	710-750	A0300B0	615.90	739.08
800	750-790	A0300C0	615.90	739.08
900	850-890	A0300D0	658.18	789.81
1000	950-990	A0300E0	765.11	918.13

Optional Side Panel

Size	Adjustment	Code	Price £ Exc. VAT	Price £ Inc. VAT
700	650-670	A0307A0	396.36	475.63
760	710-730	A0307B0	396.36	475.63
800	750-770	A0307D0	396.36	475.63
900	850-870	A0307E0	437.00	524.40

Optional Inline Panel

Size	Adjustment	Code	Price £ Exc. VAT	Price £ Inc. VAT
150	130-150	A0315B0	330.05	396.06
210	190-210	A0315C0	330.05	396.06
490 (New)	470-490	A0315D0	385.87	463.05

For Inline Panel size calculations please see page 146

Technical drawing

Bifold Door in Recess

Bifold Door with Side Panel

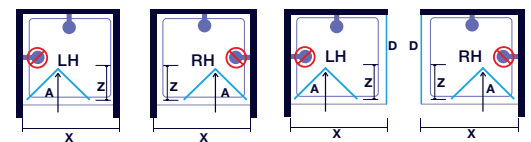

A: Moving Panel
Z: Width of panel when folded
X: Door Opening

Extension profiles available. See page 143.

Size	X	Z
760	475	315
800	515	355
900	615	405
1000	665	455

Pivot Door

The outward opening of the Ionic Express Pivot Door offers an efficient and versatile solution. It can be installed in a recess or combined with a side panel, with the option to add an inline panel.

features

- » Height 1900mm
- » Easy-fit system
- » Reversible
- » Concealed fixings
- » 20mm adjustment per wall profile



Pivot Door Shown with Side Panel / Shown as Left Hand (L)



Pivot Door Shown in Recess

Pivot Door

Size	Adjustment	Code	Price £ Exc. VAT	Price £ Inc. VAT
700	650-690	A0306A0	549.43	659.32
760	710-750	A0306B0	549.43	659.32
800	750-790	A0306D0	549.43	659.32
900	850-890	A0306E0	632.36	758.84
1000	950-990	A0306G0	696.88	836.25

Optional Side Panel

Size	Adjustment	Code	Price £ Exc. VAT	Price £ Inc. VAT
700	650-670	A0307A0	396.36	475.63
760	710-730	A0307B0	396.36	475.63
800	750-770	A0307D0	396.36	475.63
900	850-870	A0307E0	437.00	524.40

Optional Inline Panel

Size	Adjustment	Code	Price £ Exc. VAT	Price £ Inc. VAT
150	130-150	A0315B0	330.05	396.06
210	190-210	A0315C0	330.05	396.06
490 (new)	470-490	A0315D0	385.87	463.05

For Inline Panel size calculations please see page 146

Technical drawing

Pivot Door in Recess

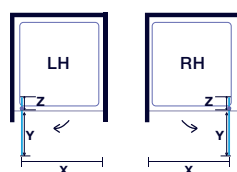

Pivot Door with Side Panel

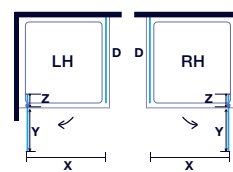

D: Side Panel
Y: Outside Door Swing
Z: Inside Door Swing
X: Door Opening

Extension profiles available.
See page 145.

Size	X	Y	Z
700	415	390	175
760	475	450	175
800	515	490	175
900	615	590	175
1000	715	690	175



6^{MM}
GLASS
THICKNESS

5 YEARS
GUARANTEE

MERSHIELD™
STAYCLEAR

IONIC | Source

Exceptional quality

Ionic Source is our exciting range of affordable 6mm shower enclosures. This range has been developed to offer our customers an exceptional quality shower enclosure at an affordable price.

EASY-FIT STEPS

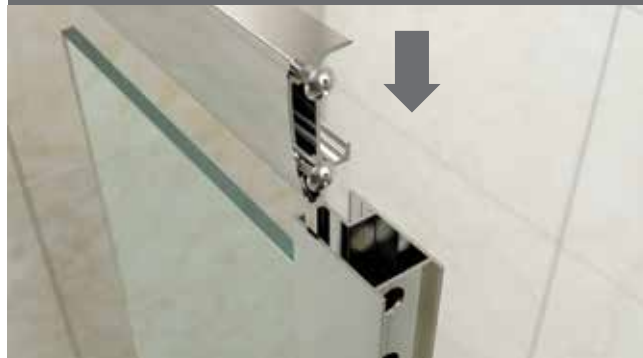

Step one: Align the horizontal and vertical profiles together.



Step two: Slot the horizontal profile and screws into upright using guide channel until flush.

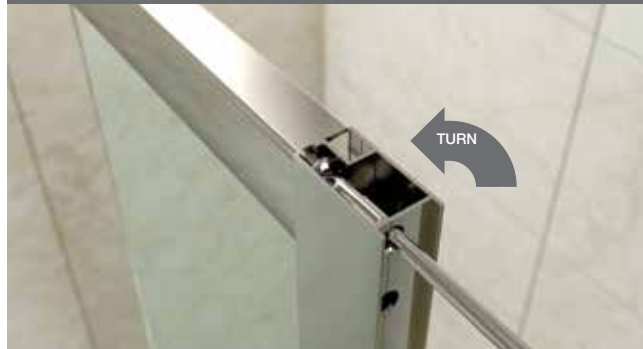

Step three: Secure screws into position using dedicated access holes.



Sliding Door with Side Panel / Shown as Left Hand (L)

Technical drawing

Sliding Door in Recess



Sliding Door with Side Panel

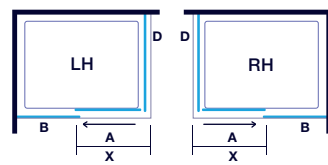

Size	X	B
1000	380	400
1100	430	450
1200	480	500

- A: Moving Panel
- B: Fixed Panel
- D: Side Panel
- X: Door Opening



Sliding Door

The Ionic Sliding Door is an ideal choice for those seeking a contemporary and affordable shower enclosure

features

- » Height 1850mm
- » Reversible
- » Easy fit frame
- » Screw cover caps
- » Magnetic seals
- » Chrome quick release easy clean bottom rollers

Sliding Door

Size	Adjustment	Code	Price £ Exc. VAT	Price £ Inc. VAT
1000	950-990	A1204A0	363.50	436.20
1100	1050-1090	A1204B0	363.50	436.20
1200	1150-1190	A1204C0	378.07	453.68

20mm Adjustment per wall profile.

Optional Side Panel

Size	Adjustment	Code	Price £ Exc. VAT	Price £ Inc. VAT
760	730-750	A1207B0	217.47	260.96
800	770-790	A1207D0	217.47	260.96
900	870-890	A1207E0	232.02	278.43



SCAN FOR MORE INFORMATION



Sliding Door in Recess

6^{MM}
GLASS
THICKNESS

5 YEARS
GUARANTEE

MERSHIELD[®]
STAYCLEAR

2 Door Quadrant

Created with affordability in mind, the Ionic Source 2 Door Quadrant offers ample showering space.

features

- » Height 1850mm
- » Reversible
- » Easy fit frame
- » Fixing cover caps
- » Magnetic seals
- » Chrome quick release easy clean bottom rollers

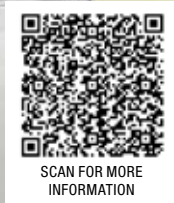

2 Door Offset Quadrant



2 Door Quadrant

2 Door Quadrant

Size	Adjustment	Code	Price £ Exc. VAT	Price £ Inc. VAT
800	770-790	A1202A0	363.50	436.20
900	870-890	A1202B0	363.50	436.20

2 Door Offset Quadrant

Size	Adjustment	Code	Price £ Exc. VAT	Price £ Inc. VAT
1000 x 800	970-990 / 770-790	A1202D0	494.85	593.82
1200 x 800	1170-1190 / 770-790	A1202HH	509.40	611.28
1200 x 900	1170-1190 / 870-890	A1202IH	523.97	628.76

Technical drawing

2 Door Quadrant

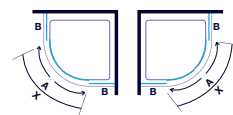

A: Moving Panel
B: Fixed Panel
C: Fixed Panels
X: Door Opening

Size	X	B	C
800	400	210	210
900	540	310	310
1000 x 800	470	410	210
1200 x 800	470	610	210
1200 x 900	540	610	310

2 Door Offset Quadrant

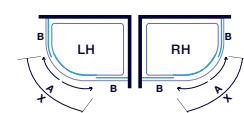

A: Moving Panel
B: Fixed Panel
C: Fixed Panels
X: Door Opening

6^{MM}
GLASS
THICKNESS

5 YEARS
GUARANTEE

MERSHIELD[®]
STAYCLEAR

Pivot Door

The Ionic Source Pivot Door offers an easy showering experience and a clean, tidy look.

features

- » Height 1850mm
- » Reversible
- » Minimalist pivot
- » Pre-assembled frame
- » Screw cover caps
- » Magnetic seals



Pivot Door with Side Panel / Shown as Right Hand (R)



Pivot Door

Pivot Door

Size	Adjustment	Code	Price £ Exc. VAT	Price £ Inc. VAT
760	710-750	A1206B0	290.40	348.48
800	750-790	A1206D0	319.67	383.60
900	850-890	A1206E0	348.79	418.55

20mm Adjustment per wall profile.

Optional Side Panel

Size	Adjustment	Code	Price £ Exc. VAT	Price £ Inc. VAT
760	730-750	A1207B0	217.47	260.96
800	770-790	A1207D0	217.47	260.96
900	870-890	A1207E0	232.02	278.43

Technical drawing

Pivot Door Recess

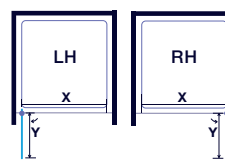

Pivot Door with Side Panel

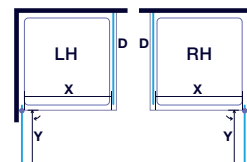

X: Door Opening
Y: Outside Door Swing

Extension profiles available. See page 143.

Size	X	Y
760	490	460
800	530	500
900	630	600



Bifold Door

The inward opening of the Ionic Source Bifold Door offers a simple and practical solution for saving space.

features

- » Height 1850mm
- » Reversible
- » Pre-assembled frame
- » Screw cover caps
- » Smooth running action
- » Magnetic seals

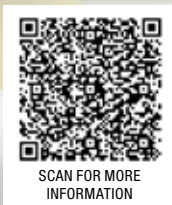

Bifold Door with Side Panel / Shown as Left Hand (L)



Bifold Door in Recess

Bifold Door

Size	Adjustment	Code	Price £ Exc. VAT	Price £ Inc. VAT
700	650-690	A1200A0	348.79	418.55
760	710-750	A1200B0	348.79	418.55
800	750-790	A1200C0	363.50	436.20
900	850-890	A1200D0	378.07	453.68

20mm Adjustment per wall profile.

Optional Side Panel

Size	Adjustment	Code	Price £ Exc. VAT	Price £ Inc. VAT
760	730-750	A1207B0	217.47	260.96
800	770-790	A1207D0	217.47	260.96
900	870-890	A1207E0	232.02	278.43

Technical drawing

Bifold Door in Recess

Bifold Door with Side Panel

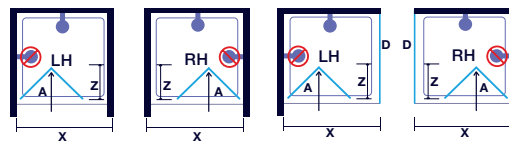

A: Moving Panel

Z: Width of panel when folded

X: Door Opening

Extension profiles available. See page 143.

Size	X	Z
700	400	280
760	460	310
800	500	330
900	600	380

6^{MM}
GLASS
THICKNESS

5 YEARS
GUARANTEE

MERSHIELD[®]
STAYCLEAR

Corner Door

The Ionic Source Corner Doors has sliding doors on both sides, offering quality and practicality in a simple design.

features

- » Height 1850mm
- » Reversible
- » Easy fit frame
- » Screw cover caps
- » Chrome quick release easy clean bottom rollers
- » Magnetic seals



Corner Door with Side Panel



SCAN FOR MORE INFORMATION



Adjustment profile close up

Corner Door

Size	Adjustment	Code	Price £ Exc. VAT	Price £ Inc. VAT
760/800	740-790	A1212V0	494.85	593.82
900	870 -890	A1212B0	509.40	611.28

20mm Adjustment per wall profile.

Technical drawing

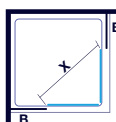

Size	X	B
760/800	350-390	300
900	460	350

X: Door Opening
B: Fixed Panels
Extension profiles available. See page 143.



6^{MM}
GLASS
THICKNESS

10 YEARS
GUARANTEE

MERSHIELD™
STAYCLEAR

MERLYN™ | 

THE EASIEST DOOR TO FIT

The innovative MERLYN IQ range takes the hassle out of fitting. The unique patented easy-fit mechanism makes fitting MERLYN IQ simple and easy to install. Slider, Quadrants and Corner doors are under British Patent No. 2,580,730

ONE PERSON FIT



Slot & lock system
- no screws



No drilling on frame



Click on rollers



Assembled on tray



Watch our
fitting video
here



Sliding Door with Side Panel / Shown as Right Hand (R)

Technical drawing

Sliding Door in Recess



Sliding Door with Side Panel

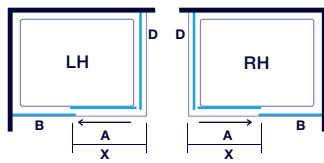

A: Moving Panel
 B: Fixed Panel
 D: Side Panel
 X: Door Opening

Extension profiles available. See page 143.

Size	X	B
1000	375	435
1100	425	485
1200	475	535
1400	575	635
1500	575	735
1600	575	835
1700	575	935



Sliding Door

With its easy clean features, the IQ Sliding Door offers a practical and economical solution.

features

- » Height 1900mm
- » 6mm Toughened Safety Glass
- » Easy Clean Frame
- » Reversible
- » Mersfield™ Easy Clean Glass
- » Chrome Designer Handle
- » 10 Year Guarantee



Slot



Secure



Click on Rollers

Sliding Door

Size	Adjustment in Recess	Adjustment with Side Panel	Code	Price £ Exc. VAT	Price £ Inc. VAT
1000	950-990	960-1000	KAS10	542.35	650.82
1100	1050-1090	1060-1100	KAS11	542.35	650.82
1200	1150-1190	1160-1200	KAS12	542.35	650.82
1400	1350-1390	1360-1400	KAS14	636.80	764.16
1500	1450-1490	1460-1500	KAS15	656.83	788.20
1600	1550-1590	1560-1600	KAS16	671.15	805.38
1700	1650-1690	1660-1700	KAS17	694.04	832.85

Optional Side Panel

Size	Adjustment	Code	Price £ Exc. VAT	Price £ Inc. VAT
700	670-690	KASP70	284.77	341.73
760	730-750	KASP76	284.77	341.73
800	770-790	KASP80	284.77	341.73
900	870-890	KASP90	307.67	369.20
1000	970-990	KASP10	384.95	461.94



SCAN FOR MORE INFORMATION



Sliding Door in Recess

6^{MM}
GLASS
THICKNESS

10 YEARS
GUARANTEE

MERSHIELD™
STAYCLEAR

1 Door Quadrant

The IQ 1 Door Quadrant is engineered for easy installation and efficient use of bathroom space.

features

- » Height 1900mm
- » 6mm Toughened Safety Glass
- » Easy Clean Frame
- » Reversible
- » Mershield™ Easy Clean Glass
- » Chrome Designer Handle
- » 10 Year Guarantee



Slot



Secure



Click on Rollers

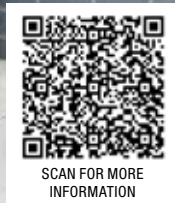

SCAN FOR MORE
INFORMATION

1 Door Quadrant / Shown as Right Hand (R)



1 Door Offset Quadrant

1 Door Quadrant

Size	Adjustment	Code	Price £ Exc. VAT	Price £ Inc. VAT
800 x 800	770-790	KA1Q80	699.77	839.72
900 x 900	870-890	KA1Q90	699.77	839.72
1000 x 1000	970-990	KA1Q100	828.55	994.26

1 Door Offset Quadrant

Size	Adjustment	Code	Price £ Exc. VAT	Price £ Inc. VAT
1000 x 800	970-990 / 770-790	KA1Q108	814.25	977.10
1200 x 800	1170-1190 / 770-790	KA1Q128	842.87	1011.44
1200 x 900	1170-1190 / 870-890	KA1Q129	880.07	1056.08

Technical drawing

1 Door Quadrant

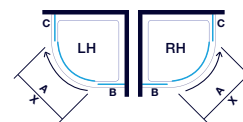

A: Moving Panel
B: Fixed Panel
C: Fixed Panel
X: Door Opening

Size	X	B	C
800 x 800	435	490	215
900 x 900	485	530	325
1000 x 1000	485	630	425
1000 x 800	435	490	425
1200 x 800	435	490	625
1200 x 900	485	530	625

1 Door Offset Quadrant

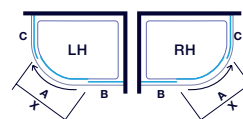

A: Moving Panel
B: Fixed Panel
C: Curved Fixed Panel
X: Door Opening



2 Door Quadrant

With two sliding doors, the IQ 2 Door Quadrant is ideal as a space-saving shower enclosure.

features

- » Height 1900mm
- » 6mm Toughened Safety Glass
- » Easy Clean Frame
- » Reversible
- » Mershield™ Easy Clean Glass
- » Chrome Designer Handle
- » 10 Year Guarantee



Slot



Secure

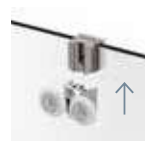

Click on Rollers



SCAN FOR MORE INFORMATION

2 Door Quadrant



2 Door Offset Quadrant

2 Door Quadrant

Size	Adjustment	Code	Price £ Exc. VAT	Price £ Inc. VAT
800 x 800	770-790	KA2Q80	513.73	616.48
900 x 900	870-890	KA2Q90	513.73	616.48

2 Door Offset Quadrant

Size	Adjustment	Code	Price £ Exc. VAT	Price £ Inc. VAT
900 x 760	870-890 / 730-750	KA2Q976	579.56	695.48
900 x 800	870-890 / 770-790	KA2Q980	613.91	736.69
1000 x 800	970-990 / 770-790	KA2Q108	622.49	746.99
1200 x 800	1170-1190 / 770-790	KA2Q128	656.83	788.20
1200 x 900	1170-1190 / 870-890	KA2Q129	685.45	822.54

Technical drawing

2 Door Quadrant

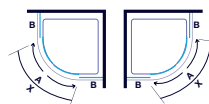

A: Moving Panel
 B: Fixed Panel
 X: Door Opening

Size	X	B	C
800 x 800	385	225	225
900 x 900	545	325	325
900 x 760	435	325	185
900 x 800	470	325	225
1000 x 800	470	425	225
1200 x 800	470	625	225
1200 x 900	545	625	325

2 Door Offset Quadrant

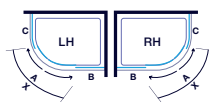

A: Moving Panel
 B: Fixed Panel
 C: Curved Fixed Panel
 X: Door Opening

6^{MM}
GLASS
THICKNESS

10 YEARS
GUARANTEE

MERSHIELDTM
STAYCLEAR

Bifold Door

The IQ Bifold door is a great option for small bathrooms with limited space.

features

- » Height 1900mm
- » 6mm Toughened Safety Glass
- » Easy Clean Frame
- » Reversible
- » Mershield™ Easy
- Clean Glass
- » Chrome Designer Handle
- » 10 Year Guarantee



Frame Locking System

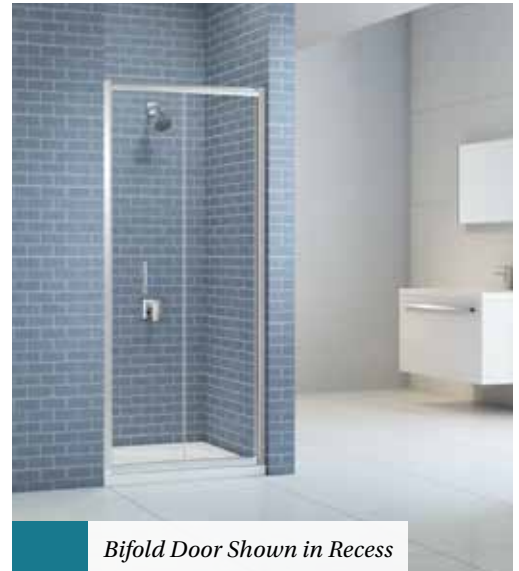

Bifold Door Shown in Recess

1 Door Quadrant / Shown as Right Hand (R) Hand (R)

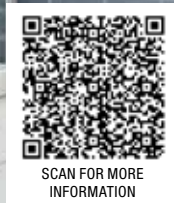

SCAN FOR MORE
INFORMATION

Bifold Door

Size	Adjustment in Recess	Adjustment with Side Panel	Code	Price £ Exc. VAT	Price £ Inc. VAT
700	650-690	655-675	KAB70	499.43	599.31
760	710-750	715-735	KAB76	499.43	599.31
800	750-790	755-775	KAB80	499.43	599.31
900	850-890	855-875	KAB90	528.05	633.66
1000	950-990	955-975	KAB10	570.97	685.17

Optional Side Panel

Size	Code	Price £ Exc. VAT	Price £ Inc. VAT	
700	662-682	KASP70	284.77	341.73
760	722-742	KASP76	284.77	341.73
800	762-782	KASP80	284.77	341.73
900	862-882	KASP90	307.67	369.20
1000	962-982	KASP10	384.95	461.94

Technical drawing

Bifold Door in Recess

Bifold Door with Side Panel

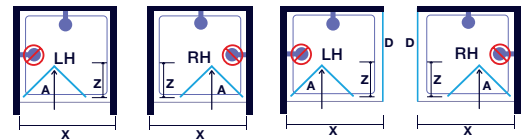

A: Moving Panel

Z: Width of panel when folded

X: Door Opening

Extension profiles available. See page 143.

Size	X	Z
700	415	300
760	460	330
800	490	350
900	570	400
1000	650	450

6^{MM}
GLASS
THICKNESS

10 YEARS
GUARANTEE

MERSHIELD™
STAYCLEAR

Pivot Door

The IQ Pivot Door provides a practical solution for easy showering and a clean, uncluttered appearance.

features

- » Height 1900mm
- » 6mm Toughened Safety Glass
- » Easy Clean Frame
- » Reversible
- » Mershield™ Easy Clean Glass
- » Chrome Designer Handle
- » 10 Year Guarantee



Frame Locking System



Pivot Door Shown in Recess



SCAN FOR MORE INFORMATION

Pivot Door Shown with Side Panel / Shown as Left Hand (L)

Pivot Door

Size	Adjustment in Recess	Adjustment with Side Panel	Code	Price £ Exc. VAT	Price £ Inc. VAT
700	650-690	655-675	KAP70	427.87	513.45
760	710-750	715-735	KAP76	450.77	540.92
800	750-790	755-775	KAP80	450.77	540.92
900	850-890	855-875	KAP90	479.39	575.27
1000	950-990	955-975	KAP10	508.01	609.61

Optional Side Panel

Size	Adjustment	Code	Price £ Exc. VAT	Price £ Inc. VAT
700	662-682	KASP70	284.77	341.73
760	722-742	KASP76	284.77	341.73
800	762-782	KASP80	284.77	341.73
900	862-882	KASP90	307.67	369.20
1000	962-982	KASP10	384.95	461.94

Technical drawing

Pivot Door Recess



Pivot Door with Side Panel

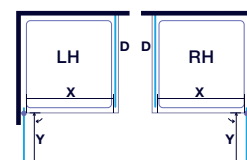

D: Side Panel
X: Door Opening
Y: Outside Door Swing

Extension profiles available. See page 143.

Size	X	Y
700	455	460
760	515	525
800	535	540
900	610	605
1000	660	655





MERLYN™

Wetroom Collection

Oh la la!

Introducing our newest Wetroom Collection!

A versatile and stylish option for your bathroom space. Choose from four stunning colours that will undoubtedly elevate your most intimate space.

Standard
Chrome



Matt
Black



Brushed
Brass



Brushed
Bronze





COMING SOON!





MERLYN™ | Wetrooms

Solution for every situation

Wetrooms are a modern and elegant option for your bathroom. With MERLYN Wetrooms, you can enjoy the best of both worlds: versatility and luxury. A MERLYN wetroom can transform the bathroom to a more clean and luxurious space.



Wetroom / with Cube Panel (F)

Fitting Options



H

U Channel



I

Flush Wall Profile



J

Flush Floor Profile

10mm Wetroom Panels

Luxurious Wetroom Panels, crafted with our signature 10mm glass. Each Wetroom panel comes with a wall profile you can tailor with various options. Pick and choose from the 9 additional options to give your wetroom the luxurious finish.

features

- » Height 2000mm
- » 10mm toughened glass
- » Choice of additional options to tailor your wetroom to suit your space
- » Suitable for a recess or corner situation
- » Suitable for wetroom and shower tray application
- » Lifetime Guarantee
- » Reversible

Wetroom Panels (including wall profile only)					Wetroom Panels with Straight Stabilising Bar (including Wall Profile)			
Size	Adjustment	Code	Price £ Exc. VAT	Price £ Inc. VAT	Additional Option	Code	Price £ Exc. VAT	Price £ Inc. VAT
300**	275-290	S10SW300	387.89	465.47	A	S10SW300	622.22	746.66
400**	375-390	S10SW400	415.47	498.56	A	S10SW400	633.31	759.97
500**	475-490	S10SW500	494.25	593.10	A	S10SW500	712.09	854.51
600**	575-590	S10SW600	554.49	665.39	A	S10SW600	772.33	926.80
700**	675-690	S10SW700	585.37	702.44	A	S10SW700	803.22	963.86
800**	775-790	S10SW800	616.27	739.52	A	S10SW800	834.10	1000.92
900**	875-890	S10SW900	647.16	776.59	A	S10SW900	865.01	1038.01
1000	975-990	S10SW1000	662.62	795.14	A	S10SW1000	880.44	1056.53
1100	1075-1090	S10SW1100	708.96	850.75	A	S10SW1100	926.78	1112.14
1200	1175-1190	S10SW1200	755.27	906.32	A	S10SW1200	973.11	1167.73
1400	1375-1390	S10SW1400	832.51	999.01	A	S10SW1400	1050.34	1260.41

*Code for ordering shower enclosure with tray. **Please Note: These sizes are the only sizes we recommend for use as end panels. We recommend a minimum opening space of 500mm.

Additional Options

Size	Product	Code	Price £ Exc. VAT	Price £ Inc. VAT
A 350	Angled Stabilising Bar	SP08SCU12320	136.00	163.20
B max 1 metre	Straight Stabilising Bar*	SP0S8TRSET N	217.42	260.90
C 400	Vertical Ceiling Bracing Bar***	CBB440	191.33	229.60
D N/A	T Bracket (to connect 2 stabilising bars)	SP0S8RTPSET	70.30	84.36
E 300	Swivel Panel 8mm glass	M8SWS30 N	375.19	450.23
F 300	Cube Panel 8mm glass**	A0413F0 N	217.88	261.45
G max 3 metres	Vertical Post	A0417C0 N	213.75	256.50
H max 1400	U channel	MGVC35A	38.29	45.95
I -	Flush Wall Profile†	SP02000FWP		
J -	Flush Floor Profile†	SP01400FFP		

*Please Note: We recommend the use of a stabilising bar for any wetroom panel over 900mm.

**Cube Panel must be fitted on a flat tray/wetroom situation.

***Please note: Max height of ceiling bar from top of glass is 400mm.

†Please Note: These are available as bespoke options. Please contact Customer Services for sizes and prices.



SCAN FOR MORE
INFORMATION



Wetroom Panel / with Swivel Panel (E)



Wetroom / with Vertical Post (G)



Wetroom Panel / with Swivel Panel (B)

Fitting Options



A
Angled Stabilising Bar



E
Corner Profile



F
Vertical Ceiling Bar



8mm Wetroom Panels

These 8mm Wetroom Panels are stylish yet functional by design. With frameless 8mm toughened safety glass, these panels stands at an impressive 2015mm high, including rail and are suitable for a recess or a corner situation. They are guaranteed to make a statement in any bathroom.

features

- » Height 2015mm including rail
- » Suitable for wetroom and shower tray application
- » 1M Stabilising bar comes as standard with all sizes
- » Suitable for recess or corner situation
- » Reversible

Wetroom Panels

Size	Tray Finish Adjustment	Code	Price £ Exc. VAT	Price £ Inc. VAT
700	670-690	M8SW201	794.44	953.33
800	770-790	M8SW211	824.30	989.16
900	870-890	M8SW221	862.96	1035.55
1000	970-990	M8SW231	873.53	1048.24
1200	1170-1190	M8SW241	920.99	1105.18

*Order code for ordering shower enclosure with tray. Please state the tray size required when order. For full information on our MStone trays see page 94. 1000mm stabilising bar comes as standard with all products.

Additional Options

Size	Product	Code	Price £ Exc. VAT	Price £ Inc. VAT
A 350	Angled Stabilising Bar	SP08SCU12320	136.00	163.20
B 300	Swivel Panel	M8SWS30 N	375.19	450.23
C 300	Cube Panel 8mm glass**	A0413F0 N	217.88	261.45
D max 3 metres	Vertical Post	A0417C0 N	213.75	256.50
E 2000	Corner profile-Glass to glass profile	A04S0003	63.32	75.98
F 400	Vertical Ceiling Bracing Bar***	CBB440	191.33	229.60

*Please Note: We recommend the use of a stabilising bar for any Wetroom Panels over 900mm.

**Cube Panel must be fitted on a flat tray/wetroom situation.

***Please note: Max height of ceiling bar from top of glass is 400mm.



SCAN FOR MORE INFORMATION



Wetroom Panel / with Cube Panel (C)



Wetroom Panel / with Vertical Post (D)

Pivot Wetroom Panels

Our 8mm Pivot Wetroom panels offers you the choice of a single wetroom panel, perfect for tight spaces, or a double wetroom panel which creates an enclosed corner situation. Choices to create the space you desire.

features

- » Height 1950mm
- » Solid chrome double handle
- » Cover caps
- » Space saving solution
- » Inward and outward opening swing
- » Concealed fixings
- » Reversible
- » Wetroom compatible solution



SCAN FOR MORE INFORMATION

Double Pivot



Double Pivot - Folded Inwards

Pivot Wetroom Panels / Single

Size	Adjustment	Code	Price £ Exc. VAT	Price £ Inc. VAT
760	690-710	S8FPV76	755.33	906.39
800	730-750	S8FPV80	783.90	940.68
900	830-850	S8FPV90	826.73	992.07
1000	930-950	S8FPV100	855.29	1026.35

Please Note: We recommend fitting this product in a Wetroom situation only.

Pivot Wetroom Panels / Double

Size	Adjustment	Code	Price £ Exc. VAT	Price £ Inc. VAT
760 x 760	690-710	S8FPC76H	755.33	906.39
800 x 800	730-750	S8FPC80H	783.90	940.68
900 x 900	830-850	S8FPC90H	826.73	992.07
1000 x 1000	930-950	S8FPC100H	855.29	1026.35

Please Note: We recommend fitting this product in a Wetroom situation only.



Single Pivot - Folded Inwards



Curved Wetroom Panels

Curved Wetroom panel follows the contour of your offset quadrant tray, giving a softer finish. The extra length of the curved panel also deflects water spray inwards. This frameless design boasts Mershield Stayclear™, ensuring peace of mind with the MERLYN Lifetime Guarantee.

features

- » Height 2015mm including rail
- » Minimalist frameless design
- » Reversible
- » Suitable for wetroom and shower tray application
- » Can be used with 800mm or 900mm trays



Curved Wetroom Panel



Curved Wetroom Panel / Overhead

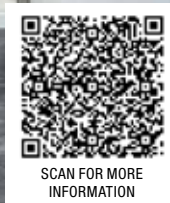

SCAN FOR MORE INFORMATION

Curved Wetroom Panels

Size	Adjustment	Code	Price £ Exc. VAT	Price £ Inc. VAT
900	885-900	S8CURV900	1072.12	1286.54
1000	985-1000	S8CURV1000	1130.95	1357.14
1200	1185-1200	S8CURV1200	1233.90	1480.68

Curved Hinged Wetroom Panels

Size	Front Panel	Hinged Panel	Code	Price £ Exc. VAT	Price £ Inc. VAT
1000	700	300	M8SWC700	926.68	1112.01
1200	900	300	M8SWC900	983.80	1180.56

Technical drawing

Panel Size	Tray Size	A	B	C
900	900 x 900	810	275	600
1000	1000 x 800	910	275	500
1200	1200 x 800 1200 x 900	1110 1110	275 275	500 600

We recommend a minimum opening of 500mm.

Wetroom application

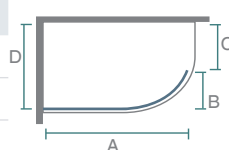

A = Panel length
 B = Panel depth
 C = Panel opening
 D = Distance from the wall to the outside of the frame should be max 970mm. This is to allow the stabilising bar to reach the wall.

A = Front Panel	B = Hinged Panel
700	300
900	300

Curved Hinged Wetroom Panel

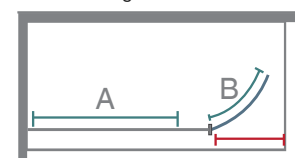

Minimum opening recommended 500mm.

Curved Wetroom Panel Foot

Code	Price £ Exc. VAT	Price £ Inc. VAT
S8CSWLEG	116.34	139.60

This foot allows for greater stability on rectangular trays and sloped wetroom floors.

Tray application



Hinged Swivel Panels

Our hinged swivel wetroom panels offers you the choice of a single wetroom panel, perfect for tight spaces, or a double wetroom panel which creates an enclosed corner situation. Choices to create the space you desire.

features

- » Height 2015mm
- » Solid chrome double handle
- » Cover caps
- » Space saving solution
- » Inward and outward opening swing
- » Concealed fixings
- » Reversible
- » Wetroom compatible solution

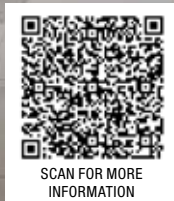

SCAN FOR MORE INFORMATION

Wetroom Panels with Hinged Swivel Panels

Walk In with Hinged Swivel Panels					
Area	Panel Size (Front+Swivel+End Panel)	Opening	Code	Price £ Exc. VAT	Price £ Inc. VAT
1200 x 800	700+350+800	500	M8SWS100H	1766.58	2119.89
1200 x 900	700+350+900	500	M8SWS400H	1805.22	2166.26
1400 x 800	900+350+800	500	M8SWS200H	1819.83	2183.80
1400 x 800	900+350+800	600			
1400 x 900	900+350+900	500	M8SWS500H	1858.51	2230.21
1500 x 900	900+350+900	600	M8SWS300H	1844.80	2213.76
1500 x 800	1000+350+800	500			
1600 x 800	1000+350+800	600	M8SWS600H	1883.47	2260.16
1500 x 900	1000+350+900	500			
1600 x 900	1000+350+900	600			

Please Note: We recommend a minimum opening space of 500mm.

Wetroom Panels with Hinged Swivel Panels						
Size	Tray Finish Adjustment	Front Panel	Swivel Panel	Code	Price £ Exc. VAT	Price £ Inc. VAT
1050	1015-1035	700	350	M8SW251	942.27	1130.72
1250	1215-1235	900	350	M8SW261	995.53	1194.64
1350	1315-1335	1000	350	M8SW271	1020.51	1224.61

Please Note: We recommend a minimum opening space of 500mm.



Folding Panels

Folding 8mm wetroom panels offers you the choice of a single wetroom panel, perfect for tight spaces, or a double wetroom panel which creates an enclosed corner situation. Choices to create the space you desire.

features

- » Height 1950mm
- » Solid chrome double handle
- » Cover caps
- » Space saving solution
- » Inward and outward opening swing
- » Concealed fixings
- » Reversible
- » Wetroom compatible solution



Folding Wetroom Panel

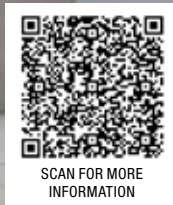

SCAN FOR MORE INFORMATION



Folding Panel / Double - open

Folding Wetroom Panels

Size	Adjustment	Code	Price £ Exc. VAT	Price £ Inc. VAT
760	680-700	M87111	973.27	1167.92
800	720-740	M87211	1006.87	1208.24
900	820-840	M87221	1072.42	1286.91
1000	920-940	M87231	1107.74	1329.28

Please Note: We recommend fitting this product in a Wetroom situation only.

Double Folding Wetroom Panels

Size	Adjustment	Code	Price £ Exc. VAT	Price £ Inc. VAT
760 x 760	715-735	M86101H	1889.83	2267.80
800 x 800	755-775	M86102H	1955.09	2346.11
900 x 900	855-875	M86103H	2082.38	2498.86
1000 x 1000	955-975	M86104H	2150.94	2581.13

Please Note: We recommend fitting this product in a Wetroom situation only



Wetroom Panel/ with Swivel Panel (F)

Technical drawing

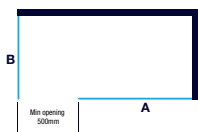

A: Front Panel
B: End Panel

Recommended opening min
500mm

The black colour layer is not applied to the surface like paint or plating, but is fully integrated with the underlying aluminium substrate, so it cannot chip or peel.



8mm Black Frameless Panels

Black Frameless Wetroom Panels come in several sizes, offering you the option to mix and match your choice of space combinations. With 8mm glass and the option of a matte black vertical post, brings a strong feature with great height to your bathroom.

features

- » Height 2015mm including rail
- » Minimalist frameless design
- » 8mm toughened glass
- » Reversible
- » Anodised aluminium matte black finish - more durable than powder coating
- » Suitable for wetroom and shower tray application
- » Mershiield Stayclear™

Frameless Wetroom Panels

Size	Adjustment	Code	Price £ Exc. VAT	Price £ Inc. VAT
700	675 - 690	BLKSW700	705.44	846.53
800	775 - 790	BLKSW800	705.44	846.53
900	875 - 890	BLKSW900	737.79	885.35
1000	975 - 990	BLKSW1000	747.36	896.84
1100	1075 - 1090	BLKSW1100	777.30	932.76
1200	1175 - 1190	BLKSW1200	788.09	945.71

See table below for waste cap options.

**Please note: Vertical Post is an optional extra and must be ordered if required. See information below.

Additional Options

Size	Product	Code	Price £ Exc. VAT	Price £ Inc. VAT
Max 3 metres	Corner profile	A04S0003BN	117.10	140.52
Max 3 metres	Vertical post**	BLK3MCP	238.35	286.02
300	Swivel panel	BLKSVL300	457.95	549.53
-	T shaped bracket	A04S0010B	100.04	120.05
-	White waste cap	DWASCAPWHT	17.12	20.54

White Waste Cap is for MStone and Touchstone trays only. Waste cap comes in chrome as standard. The Swivel Panel can be retro fitted. Radius of Swivel Panel = 315mm. 180° opening.



SCAN FOR MORE INFORMATION



SCAN FOR MORE INFORMATION



Wetroom Panel / with End Panel



Wetroom / with Vertical Post



Double Entry Showerwall

Technical drawing

Double Entry



Showerwall Walk-In

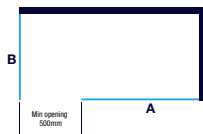

A: Front Panel
B: End Panel

Recommended opening min
500mm

The black colour layer is not applied to the surface like paint or plating, but is fully integrated with the underlying aluminium substrate, so it cannot chip or peel.



8mm Black Wetrooms

Our Black Wetroom Panels are the best to arrive onto the scene. Creating a feature of your showering space, a Showerwall or Walk-In feature, this statement piece gives your bathroom the wow it's been waiting for.

features

- » Height 2000
- » 8mm toughened glass
- » Anodised aluminium matte black finish- more durable than powder coating
- » Bracing bar sits flush with shower panel
- » Full metal frame on the outside only - retaining easy clean feature on inside
- » Mershield Stayclear™

Squared Showerwall

Size	Adjustment	Code	Price £ Exc. VAT	Price £ Inc. VAT
900	875 - 890	BLKFSWCTL90	1492.20	1790.64
1000	975 - 990	BLKFSWCTL100	1520.38	1824.45
1200	1175 - 1190	BLKFSWCTL120	1604.93	1925.91

Bracing bar comes as standard on all sizes.

Double Entry Squared Showerwall

Size	Adjustment	Code	Price £ Exc. VAT	Price £ Inc. VAT
1200	-	BLKFSWCTL120D	1662.83	1995.40

Bracing bar comes as standard on all sizes.

Additional Options

Size	Product	Code	Price £ Exc. VAT	Price £ Inc. VAT
-	White Waste Cap	DWASCAPWHT	17.12	20.54

*White Waste Cap is for MStone and Touchstone trays only. Waste cap comes in chrome as standard.



SCAN FOR MORE INFORMATION



Squared Showerwall



Squared Walk-In



4^{MM}
GLASS
THICKNESS

6^{MM}
GLASS
THICKNESS

8^{MM}
GLASS
THICKNESS

10^{MM}
GLASS
THICKNESS

LIFETIME
GUARANTEE

MERSHIELD[™]
STAYCLEAR

MERLYN[™] | Bath Screens

Innovation meets aesthetics

Innovative design and contemporary aesthetics bring this bathroom favourite to life. This modern collection has been created with the same superb materials and unrelenting attention to detail demonstrated across all MERLYN ranges.

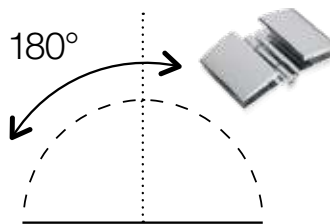

180° inwards swing

The signature piece of this range, the Two Panel Hinged Bath Screen features a secure 180° inwards swing which means you can position the glass where you can comfortably deflect water into the bath and not on to the floor!

Rise and fall

All MERLYN Bath Screens have a rise and fall hinge to make it easier for you to open.

MERLYN

bath screens

.SecureSeal.
by MERLYN

6^{MM}
GLASS
THICKNESS

LIFETIME
GUARANTEE

MERSHIELD™
STAYCLEAR

The Ultimate Leak-free Bath Screen Range

The SecureSeal by MERLYN has been designed with a leak free sealing arm which extends from the profile to create a complete seal between the bath and screen. When not in use the arm simply folds away back into the profile.

SecureSeal by MERLYN offers functional and easy to use designs to complement any bathroom space. With glass screen heights of 1500mm and 6mm glass, our SecureSeal by MERLYN range allows you to enjoy peace of mind in a leak free shower experience for years to come.

This range has been designed with the same superb materials and unrelenting attention to detail demonstrated across all MERLYN ranges.

How SecureSeal works

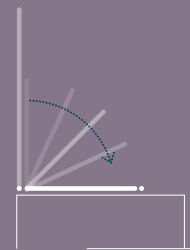

01.
Pull down arm from storage position.

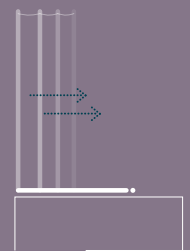

02.
Extend screen and locate panels.

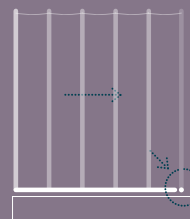

03.
Fully extend and clip into position for a secure fit and tight seal.

SecureSeal Lock



This is the SecureSeal Leak Free Sealing Arm



some unique features

MERLYN EASY-FIT

Replace your Bath Screen with Ease

An innovative way to replace your bath screen without the need to re-drill the wall. Simply connect your easy-fit to the existing holes in the wall and install your new bath screen.



NO DRILLING



SCAN FOR
EASY-FIT VIDEO

HydraSEAL

Exclusive to MERLYN Bath Screens

HydraSEAL acts as an extra barrier, sealing the gap between the seal and the pivot point where water can usually escape.

It contains a high density foam that compresses onto the bath screen to form a tight seal and restricts water escaping from this problem area.

Fitting Steps

Easy-Fit profile



01.
Remove the
old profile

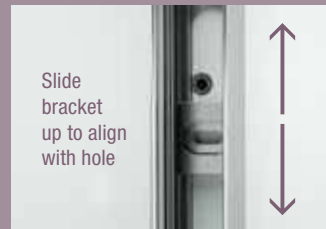

Slide
bracket
up to align
with hole

02.
Position the
EASY-fit profile
on the wall



03.
Adjust the
brackets to align
to the existing
holes and fix in
position

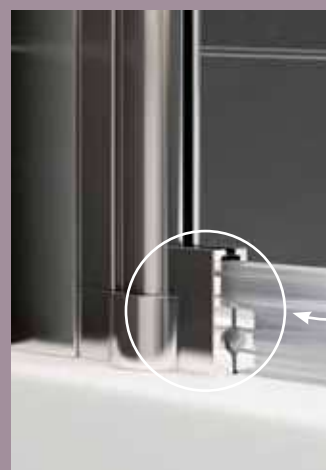

HydraSEAL
creates a barrier
to restrict leaking!

EASY FIT and **HydraSEAL** are Available with following Bath Screens: **MB1 / MB2 / MB3 / MB3A / MB3B / MB3C**

SecureSeal Single Panel

features

- » Mershield Stayclear™ protected glass
- » Reversible
- » Lifetime Guarantee



SecureSeal Single Panel					
Size	Code	Panel	Product Adjustment	Price £ Exc. VAT	Price £ Inc. VAT
800 x 1500	MS1	1	780 - 800mm	335.75	402.90

Technical drawing



A: Moving Panels (screen width when folded into the bath 712mm)

○ Recommended shower head position

SecureSeal 4 Fold

features

- » Mershield Stayclear™ protected glass
- » Reversible
- » Lifetime Guarantee



SecureSeal 4 Fold					
Size	Code	Panel	Product Adjustment	Price £ Exc. VAT	Price £ Inc. VAT
800 x 1500	MS4	4	780 - 800	560.54	672.65

Technical drawing



A: Moving Panels (screen width when folded into the bath 226mm)
B: Fixed Panel

○ Recommended shower head position

SecureSeal 5 Fold

features

- » Mershield Stayclear™ protected glass
- » Reversible
- » Lifetime Guarantee



SecureSeal 5 Fold					
Size	Code	Panel	Product Adjustment	Price £ Exc. VAT	Price £ Inc. VAT
1000 x 1500	MS5	5	980 - 1000	630.86	757.04

Technical drawing



A: Moving Panels (screen width when folded into the bath 178mm)

☐ Recommended shower head position

SecureSeal Fixed Panel

features

- » Mershield Stayclear™ protected glass
- » Reversible
- » Lifetime Guarantee



SecureSeal Fixed Panel					
Size	Code	Panel	Product Adjustment	Price £ Exc. VAT	Price £ Inc. VAT
300 x 1500	MSFP	1	300 -320	265.59	318.70

Technical drawing



A: Moving Panel
B: Fixed Panel

☐ Recommended shower head position

Single Square Fixed Panel

features

- » 6mm toughened safety glass
- » Reversible



Single Curved

features

- » 6mm toughened safety glass
- » Reversible
- » Featuring HydraSeal



Single Square Fixed Panel

Size	Code	Panel	Product Adjustment	Price £ Exc. VAT	Price £ Inc. VAT
800x1500	MB0	1	785-800	159.92	191.91

Single Curved

Size	Code	Panel	Product Adjustment	Price £ Exc. VAT	Price £ Inc. VAT
800 x 1500	MB1	1	780-800	218.27	261.92

Single Curved - Easy-Fit Bundle

800 x 1500	MB1FLEX	1	780-800	279.31	335.17
------------	---------	---	---------	--------	--------

Technical drawing



B - Fixed Panel

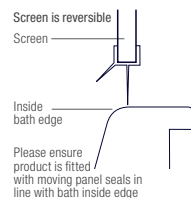

○ Recommended shower head position

Technical drawing



A - Moving Panel
Y - Radius of swing= 733mm
Door swings 90° inwards and outwards

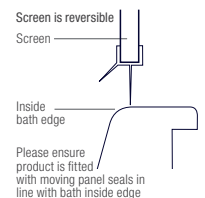

○ Recommended shower head position

Single Square

features

- » 6mm toughened safety glass
- » Reversible
- » Featuring HydraSeal



Single Square with Towel Rail

features

- » 6mm toughened safety glass
- » Reversible
- » Featuring HydraSeal
- » Includes towel rail



BATH SCREENS

Single Square

Size	Code	Panel	Product Adjustment	Price £ Exc. VAT	Price £ Inc. VAT
800 x 1500	MB2	1	780-800	258.20	309.85

Single Square - Easy-Fit Bundle

800 x 1500	MB2FLEX	1	780-800	317.67	381.20
------------	---------	---	---------	--------	--------

Single Square With Towel Rail

Size	Code	Panel	Product Adjustment	Price £ Exc. VAT	Price £ Inc. VAT
800 x 1500	MB2T	1	780-800	324.30	389.16

Technical drawing



A - Moving Panel
Y - Radius of swing = 733mm
Door swings 90° inwards and outwards

○ Recommended shower head position

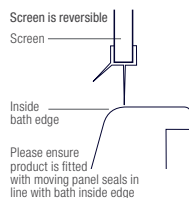

Technical drawing



A - Moving Panel
Y - Radius of swing = 733mm
Door swings 90° inwards and outwards

○ Recommended shower head position

2 Panel Curved

features

- » 6mm toughened safety glass
- » Reversible
- » Featuring HydraSeal
- » Includes towel rail



2 Panel Curved					
Size	Code	Panel	Product Adjustment	Price £ Exc. VAT	Price £ Inc. VAT
1150 x 1500	MB3	2	1130 - 1150	610.16	732.20
2 Panel Curved - EASY-FIT BUNDLE					
1150 x 1500	MB3FLEX	2	1130 - 1150	656.06	787.27

Technical drawing



- A - Moving Panel
- B - Fixed Panel
- Y - Radius of swing = 733mm
- Door swings 90° inwards and outwards
- Recommended shower head position

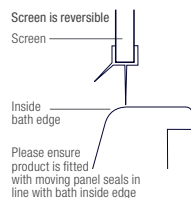

2 Panel Folding Curved

features

- » 6mm toughened safety glass
- » Reversible
- » Featuring HydraSeal



2 Panel Folding Curved					
Size	Code	Panel	Product Adjustment	Price £ Exc. VAT	Price £ Inc. VAT
900 x 1500	MB3A	2	880 - 900	360.68	432.82
2 Panel Folding Curved - EASY-FIT BUNDLE					
900 x 1500	MB3AFLEX	2	880 - 900	416.18	499.42

Technical drawing



- A - Moving Panel
- B - Fixed Panel
- Y - Radius of swing = 483mm
- Door swings 90° inwards and outwards
- Recommended shower head position

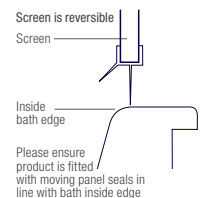

2 Panel Folding Square

features

- » 6mm toughened safety glass
- » Reversible
- » Featuring HydraSeal



2 Panel Square

Size	Code	Panel	Product Adjustment	Price £ Exc. VAT	Price £ Inc. VAT
900 x 1500	MB3B	2	880 - 900	360.68	432.82

2 Panel Square - EASY-FIT BUNDLE

900 x 1500	MB3BFLEX	2	880 - 900	416.18	499.42
------------	----------	---	-----------	--------	--------

Technical drawing



- A - Moving Panel
- B - Fixed Panel
- Y - Radius of swing = 483mm
- Door swings 90° inwards and outwards
- Recommended shower head position

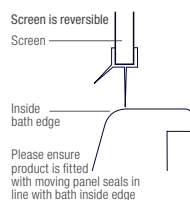

2 Panel Curved

features

- » 6mm toughened safety glass
- » Reversible
- » Featuring HydraSeal



2 Panel Curved

Size	Code	Panel	Product Adjustment	Price £ Exc. VAT	Price £ Inc. VAT
900 x 1500	MB3C	2	880 - 900	360.68	432.82

2 Panel Curved - EASY-FIT BUNDLE

900 x 1500	MB3CFLEX	2	880 - 900	416.18	499.42
------------	----------	---	-----------	--------	--------

Technical drawing



- A - Moving Panel
- B - Fixed Panel
- Y - Radius of swing = 383mm
- Door swings 90° inwards and outwards
- Recommended shower head position

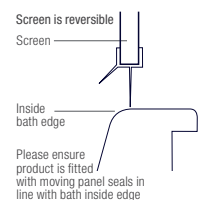

4 Fold

features

- » 4mm toughened safety glass
- » Reversible



4 Fold					
Size	Code	Panel	Product Adjustment	Price £ Exc. VAT	Price £ Inc. VAT
850 x 1400	MB4	4	845 - 850	428.47	514.16

Technical drawing



A - Moving Panel (Panel width 200mm)

○ Recommended shower head position

Curved Curtain Rail

features

- » 6mm toughened safety glass
- » Reversible



Curtain Rail - Curved					
Size	Code	Panel	Product Adjustment	Price £ Exc. VAT	Price £ Inc. VAT
300 x 1500	MB5	1	300 - 320	287.09	344.51

Technical drawing



B - Fixed Panel
E - Curtain rail

○ Recommended shower head position

Curtain Rail

features

- » 6mm toughened safety glass
- » Reversible



Curtain Rail In Recess

Size	Code	Panel	Product Adjustment	Price £ Exc. VAT	Price £ Inc. VAT
300 x 1500	MB5A	1	300 - 320	287.09	344.51

Technical drawing



Height is 1500mm including rail
 B - Fixed Panel
 E - Curtain rail

Recommended shower head position

Hinged Square

features

- » 8mm toughened safety glass
- » Reversible



Hinged Square

Size	Code	Panel	Product Adjustment	Price £ Exc. VAT	Price £ Inc. VAT
850 x 1500	MB6	1	850 - 870	573.93	688.72

Technical drawing



Y - Radius of swing = 810mm
 Door swings 90° outwards only

Recommended shower head position

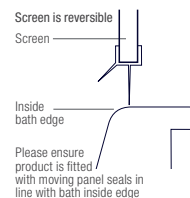

2 Panel Hinged

features

- » 8mm toughened safety glass
- » This product is handed



2 Panel Fixed with Hinge Panel

features

- » 8mm toughened safety glass
- » This product is handed



2 Panel Hinged - Left Hand And Right Hand					
Size	Code	Panel	Product Adjustment	Price £ Exc. VAT	Price £ Inc. VAT
900 x 1500	MB7L Left Handed	2	880 - 900	699.54	839.45
900 x 1500	MB7R Right Handed	2	880 - 900	699.54	839.45

2 Panel Fixed With Hinge Panel - Left Hand And Right Hand					
Size	Code	Panel	Product Adjustment	Price £ Exc. VAT	Price £ Inc. VAT
1500 x 900	MB7AL Left Handed	2	830 - 850	672.66	807.19
1500 x 900	MB7AR Right Handed	2	830 - 850	672.66	807.19

Technical drawing

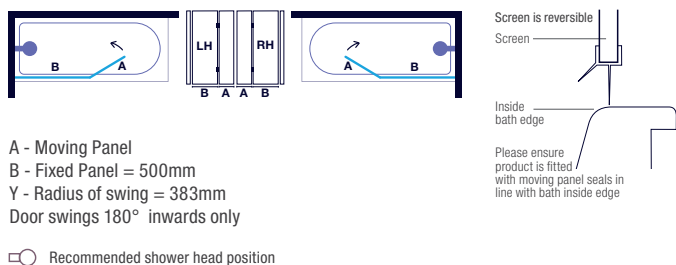

Technical drawing

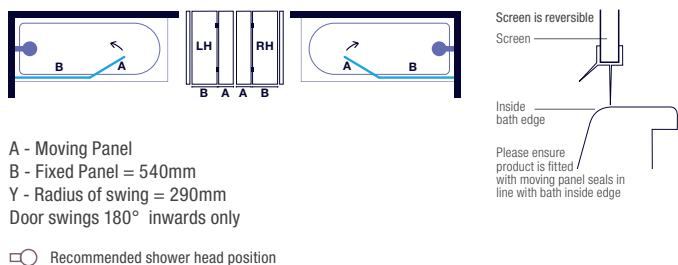

2 Panel Folding

features

- » 8mm toughened safety glass
- » Reversible



2 Panel Folding

Size	Code	Panel	Product Adjustment	Price £ Exc. VAT	Price £ Inc. VAT
1100 x 1500	MB8	2	1080 - 1100	695.76	834.91

Technical drawing

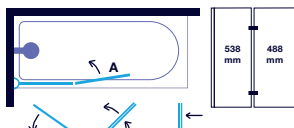

- A - Moving Panel
 B - Fixed Panel
 Y - Radius of swing = 570mm
 Door swings 90° inwards and outwards
 ○ Recommended shower head position

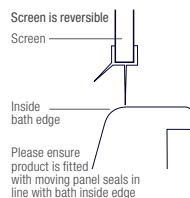

3 Panel Folding

features

- » 8mm toughened safety glass
- » Reversible



3 Panel Folding

Size	Code	Panel	Product Adjustment	Price £ Exc. VAT	Price £ Inc. VAT
1400 x 1500	MB9	3	1380 - 1400	870.08	1,044.10

Technical drawing

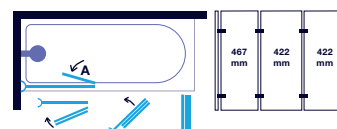

- Y - Panel Swing
 Screen swing 90° inwards & outwards
 ○ Recommended shower head position

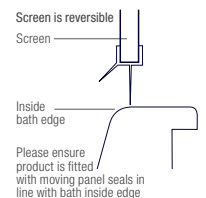

Single Square

features

- » 8mm toughened safety glass
- » Reversible
- » Includes towel rail



Single Curved

features

- » 8mm toughened safety glass
- » Reversible



Single Square					
Size	Code	Panel	Product Adjustment	Price £ Exc. VAT	Price £ Inc. VAT
800 x 1500	MB10	1	780 - 800	565.03	678.03

Single Curved					
Size	Code	Panel	Product Adjustment	Price £ Exc. VAT	Price £ Inc. VAT
800 x 1500	MB11	1	780 - 800	494.22	593.07

Technical drawing

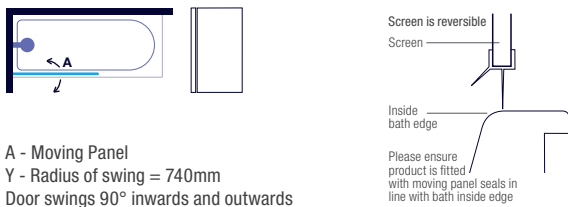

○ Recommended shower head position

Technical drawing



○ Recommended shower head position

Single Square

features

- » 5mm toughened safety glass
- » Reversible



2 Panel Folding

features

- » 8mm toughened safety glass
- » Reversible



Single Square

Size	Code	Panel	Product Adjustment	Price £ Exc. VAT	Price £ Inc. VAT
800 x 1400	MB12	1	790 - 800	1658.53	202.23

2 Panel Folding

Size	Code	Panel	Product Adjustment	Price £ Exc. VAT	Price £ Inc. VAT
1100 x 1500	MB13	2	1080 - 1100	565.03	678.03

Technical drawing



A - Moving Panel
Y - Radius of swing = 750mm
Door swings 90° inwards & Outwards

Recommended shower head position

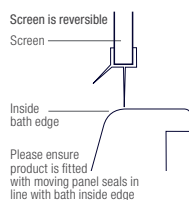

Technical drawing

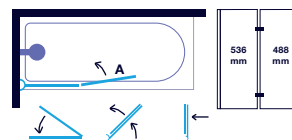

A - Moving Panel
Y - Radius of swing = 560mm

Recommended shower head position

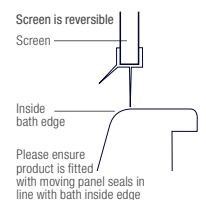

Fixed Single Square

features

- » 5mm toughened safety glass
- » Reversible



Fixed Single Square

Size	Code	Panel	Product Adjustment	Price £ Exc. VAT	Price £ Inc. VAT
800 x 1500	MB14	1	785-800	281.80	338.16

Fixed Framed

features

- » 8mm toughened glass and Mershield Stayclear™™
- » Anodised aluminium matte black finish - more durable than powder coating
- » Reversible



MERLYN Black Fixed Framed

Size	Code	Panel	Product Adjustment	Price £ Exc. VAT	Price £ Inc. VAT
1500x800	BLKFMB0	1	775-790	669.31	803.17

Technical drawing



B - Fixed Panel

○ Recommended shower head position

Technical drawing



B - Fixed Panel

○ Recommended shower head position

Two Panel Hinged

features

- » Minimalist frameless design
- » 8mm toughened glass
- » Anodised aluminium matte black finish - more durable than powder coating
- » This product is handed



MERLYN Black Hinged 2 Panel - Left Hand And Right Hand

Size	Code	Panel	Product Adjustment	Price £ Exc. VAT	Price £ Inc. VAT
1500x900	BLKMB7L	2	880-890	717.42	860.90
1500x900	BLKMB7R	2	880-890	717.42	860.90

Technical drawing

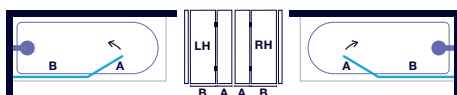

A - Moving Panel
 B - Fixed Panel = 900mm
 Y - Radius of swing = 383mm
 Door swings 180° inwards only

○ Recommended shower head position

Screen is reversible
 Screen
 Inside bath edge
 Please ensure product is fitted with moving panel seals in line with bath inside edge

Fixed Square

features

- » Minimalist frameless design
- » 8mm toughened glass & MerShield Stayclear™™
- » Anodised aluminium matte black finish - more durable than powder coating
- » Reversible



MERLYN Black Fixed Square

Size	Code	Panel	Product Adjustment	Price £ Exc. VAT	Price £ Inc. VAT
1500x800	BLKMB0	1	785-800mm	294.49	353.39

Technical drawing



B - Fixed Panel

○ Recommended shower head position





MERLYN™ | trays

Sculpted, elegance & durability

Beautifully sculpted shower trays, angled and contoured to match all enclosures and spaces, achieving the perfect combination of luxury, elegance and durability.

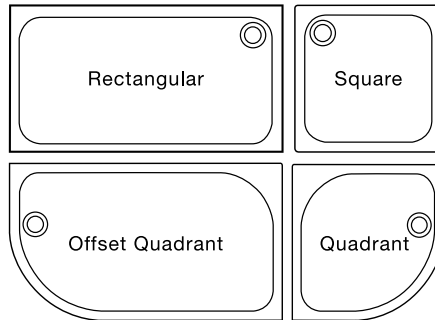

Offset Quad is handed. Please choose L for Left or R for Right when ordering.



Left Handed (L) Right Handed (R)



MERLYN Truestone Shower Tray - Graphite

Choose your colour?



White
Code W

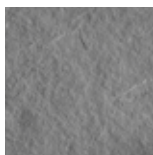

Fossil Grey
Code F



Graphite
Code G

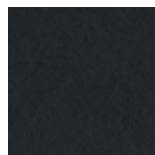

Black
Code B



Sandstone
Code S



TRUESTONE®

Beautifully handcrafted and ultra-low slate trays, elegant in appearance and luxurious to touch. With 5 finishes to choose from. These trays will bring an element of natural beauty and a truly designer finish to your bathroom.

features

- » Ultra Slim: only 30mm in height.
- » Handcrafted from high grade stone resin.
- » Integrated Discreet Waste.
- » Luxurious Textured Finish.
- » Can be fitted on or level with floor.
- » Comes with 90mm Fast Flow Waste.
- » Our self cleaning vortex design: Offers a maintenance free solution as it doesn't require any cleaning.

Rectangular & Square Trays (add the colour code to the below codes to order)

Size	Code	Price £ Exc. VAT	Price £ Inc. VAT
900 x 900	T90RT	490.00	588.00
1000 x 800	T108RT	465.83	559.00
1200 x 800	T128RT	551.67	662.00
1200 x 900	T129RT	619.17	743.00
1400 x 800	T148RT	613.33	736.00
1400 x 900	T149RT	674.17	809.00
1500 x 800	T158RT	648.33	778.00
1500 x 900	T159RT	825.00	990.00
1600 x 800	T168RT	692.50	831.00
1600 x 900	T169RT	894.17	1073.00
1700 x 800	T178RT	760.00	912.00
1700 x 900	T179RT	923.33	1108.00

All trays come with a MERLYN 90mm fast flow waste.
All tray codes need the corresponding colour code on the opposite page e.g. T108RTW

Quadrant Tray (add the colour code to the below codes to order)

Size	Code	Price £ Exc. VAT	Price £ Inc. VAT
900 x 900	T90Q	438.33	526.00

Offset Quadrant Tray (add the colour code to the below codes to order)

Size	Code	Price £ Exc. VAT	Price £ Inc. VAT
1000 x 800	T108H (L or R)	575.00	690.00
1200 x 900	T129H (L or R)	674.17	809.00

This product is handed – please choose L for Left Hand and R for Right Hand when ordering. All tray codes need the corresponding colour code on the opposite page e.g. T108RTW

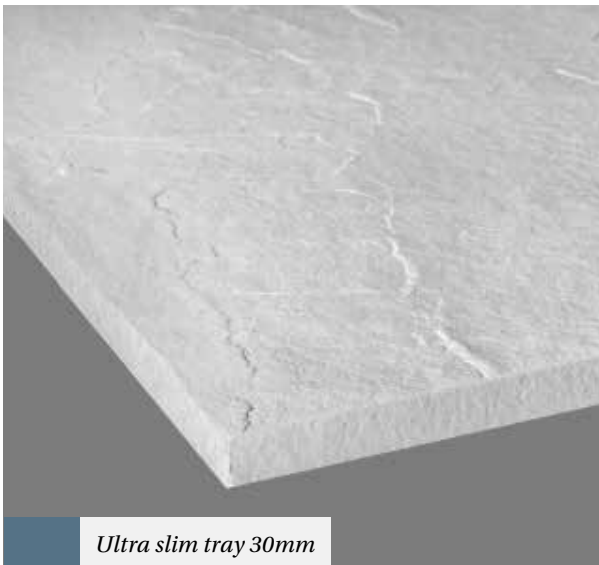
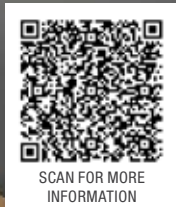

Ultra slim tray 30mm



MERLYN branded Waste Cover



Level25 Tray

Tray types



Square tray



Level25 Rectangle tray



Quadrant tray

Please note:

The Level 25 tray must be fitted with the waste positioned along the back wall and **not** to the front.



*Quadrant tray is handed – please choose L for Left Hand and R for Right Hand when ordering.



25 YEARS
GUARANTEE



EASY
CLEAN

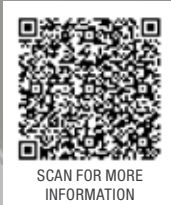

SCAN FOR MORE
INFORMATION

LEVEL 25¹

The luxury satin look and feel is designed to give confidence while not feeling harsh underfoot.

features

- » Ultra slim 25mm low level tray
- » Sleek minimalist design
- » Discreet integrated waste cover
- » Can be fitted on or level with floor
- » Comes with 90mm fast flow waste
- » Shower tray 25 year guarantee
- » Available in square, rectangular and quadrant

Rectangular & Square Trays

Size	Code	Price £ Exc. VAT	Price £ Inc. VAT
900 x 900	L90SQ	376.74	452.09
1000 x 800	L108RT	376.74	452.09
1000 x 900	L109RT	411.14	493.37
1100 x 800	L118RT	411.14	493.37
1100 x 900	L119RT	411.14	493.37
1200 x 760	L1276RT	411.14	493.37
1200 x 700	L127RT	411.13	493.36 NEW
1200 x 800	L128RT	411.14	493.37
1200 x 900	L129RT	428.35	514.02
1300 x 800	L138RT	612.37	734.85
1300 x 900	L139RT	612.37	734.85
1400 x 760	L1476RT	612.37	734.85
1400 x 800	L148RT	612.37	734.85
1400 x 900	L149RT	612.37	734.85
1500 x 800	L158RT	658.86	790.63
1500 x 900	L159RT	658.86	790.63
1600 x 800	L168RT	686.38	823.65
1600 x 900	L169RT	686.38	823.65
1700 x 760	L1776RT	686.38	823.65
1700 x 800	L178RT	780.99	937.19
1700 x 900	L179RT	786.16	943.40

All trays come with a MERLYN 90mm fast flow waste.

Quadrant Tray

Size	Code	Price £ Exc. VAT	Price £ Inc. VAT
900 x 900	L90Q	440.72	528.86
*1200 x 900	L129QL	604.54	725.45
*1200 x 900	L129QR	604.54	725.45

All trays come with a MERLYN 90mm fast flow waste.

This product is handed – please choose L for Left Hand and R for Right Hand when ordering.



Level25-SR Tray

Tray types



Square tray



Level25-SR Rectangle tray



Quadrant tray

Please note:
The Level 25 tray must be fitted with the waste positioned along the back wall and **not** to the front.



*Quadrant tray is handed – please choose L for Left Hand and R for Right Hand when ordering.



25 YEARS
GUARANTEE



EASY
CLEAN

LEVEL 25⁺-SR

We have carried out all the testing to give you and your family the peace of mind of showering in a safe environment and the splendour of this natural stone effect.

features

- » Ultra slim 25mm low level tray
- » Slip-resistant is manufactured into the coating and won't wear
- » Sleek minimalist design
- » Discreet integrated waste cover
- » Can be fitted on or level with floor
- » Comes with 90mm fast flow waste
- » Shower tray 25 year guarantee
- » Available in square, rectangular and quadrant

Rectangular & Square Trays

Size	Code	Price £ Exc. VAT	Price £ Inc. VAT
900 x 900	L90SQAS	527.44	632.92
1000 x 800	L108RTAS	527.44	632.92
1000 x 900	L109RTAS	575.59	690.71
1100 x 800	L118RTAS	575.59	690.71
1100 x 900	L119RTAS	575.59	690.71
1200 x 700	L127RTAS	575.59	690.71 NEW
1200 x 800	L128RTAS	575.59	690.71
1200 x 900	L129RTAS	599.69	719.63
1300 x 800	L138RTAS	857.30	1028.76
1300 x 900	L139RTAS	857.30	1028.76
1400 x 760	L1476RTAS	857.30	1028.76
1400 x 800	L148RTAS	857.30	1028.76
1400 x 900	L149RTAS	857.30	1028.76
1500 x 800	L158RTAS	922.40	1106.88
1500 x 900	L159RTAS	922.40	1106.88
1600 x 800	L168RTAS	960.95	1153.14
1600 x 900	L169RTAS	960.95	1153.14
1700 x 800	L178RTAS	1093.39	1312.06
1700 x 900	L179RTAS	1100.63	1320.75

All trays come with a MERLYN 90mm fast flow waste.

Quadrant Tray

Size	Code	Price £ Exc. VAT	Price £ Inc. VAT
900 x 900	L90QAS	616.99	740.39
*1200 x 900	L129QLAS	846.35	1015.63
*1200 x 900	L129QRAS	846.35	1015.63

All trays come with a MERLYN 90mm fast flow waste.

This product is handed – please choose L for Left Hand and R for Right Hand when ordering.



SCAN FOR MORE
INFORMATION



SCAN FOR video



*Exceeds Class C for DIN 51097 - Barefoot ramp test.
This ranks MERLYN in a premium class.*



Touchstone Tray

Design details



Graduated adjustable leg and easy-fit tray panel kit.



Adjustable leg system.



90mm fast flow waste, includes hair trap and chrome cover.



*Quadrant tray is handed – please choose L for Left Hand and R for Right Hand when ordering.



TOUCHSTONE

The luxury satin look and feel is designed to give confidence while not feeling harsh underfoot. The Touchstone tray is capped with an easy to clean surface that provides a chemical resistant, anti-bacterial solution due to it's ultra-smooth, non-porous surface.

features

- » 10 Year Guarantee
- » 50mm high to achieve minimalist design
- » Available as low level or with tray panel kits for easy installation
- » Compatible 90mm fast flow waste also available
- » More than 30 sizes available

Rectangular & Square Trays

Size	Code	Tray Panel Kit	Price £ Exc. VAT	Price £ Inc. VAT
760 x 760	S76SQ	Kit 4	115.63	138.76
800 x 800	S80SQ	Kit 4	129.57	155.48
900 x 900	S90SQ	Kit 4	149.64	179.56
800 x 700	S870RT	Kit 4	174.01	208.81
800 x 760	S876RT	Kit 4	174.01	208.81
900 x 700	S970RT	Kit 4	190.15	228.18
900 x 760	S976RT	Kit 4	190.15	228.18
900 x 800	S980RT	Kit 4	190.15	228.18
1000 x 700	S107RT	Kit 4	196.35	235.62
1000 x 760	S1076RT	Kit 4	196.35	235.62
1000 x 800	S108RT	Kit 4	196.35	235.62
1000 x 900	S109RT	Kit 4	203.89	244.66
1100 x 800	S118RT	Kit 4	203.89	244.66
1200 x 700	S127RT	Kit 4	203.89	244.66
1200 x 760	S1276RT	Kit 4	213.61	256.33
1200 x 800	S128RT	Kit 4	226.42	271.70
1200 x 900	S129RT	Kit 4	243.00	291.60
1300 x 800	S138RT	Kit 3	315.39	378.47
1400 x 700	S147RT	Kit 3	324.85	389.82
1400 x 760	S1476RT	Kit 3	324.85	389.82
1400 x 800	S148RT	Kit 3	324.85	389.82
1400 x 900	S149RT	Kit 3	342.37	410.85
1500 x 700	S157RT	Kit 3	360.95	433.14
1500 x 760	S1576RT	Kit 3	381.12	457.34
1500 x 800	S158RT	Kit 3	381.12	457.34
1500 x 900	S159RT	Kit 3	401.17	481.40
1600 x 700	S167RT	Kit 3	425.28	510.34
1600 x 800	S168RT	Kit 3	425.28	510.34
1600 x 900	S169RT	Kit 3	446.53	535.84
1685 x 700	S177RT	Kit 3	460.70	552.85
1680 x 760	S1776RT	Kit 3	474.88	569.85
1700 x 800*	S178RT	Kit 3	516.70	620.04
1700 x 900*	S179RT	Kit 3	556.56	667.87
1800 x 800*	S188RT	Kit 3	664.5	797.40

*Waste is centred on 1700x800 & 1800x800 trays.

Quadrant Tray

Size	Code	Tray Panel Kit	Price £ Exc. VAT	Price £ Inc. VAT
800 x 800	S80Q	Kit 2	141.76	170.12
900 x 900	S90Q	Kit 2	158.45	190.14
*1000 x 800 LH	S108QL	Kit 1	215.08	258.10
*1000 x 800 RH	S108QR	Kit 1	215.08	258.10
*1200 x 800 LH	S128QL	Kit 1	226.42	271.70
*1200 x 800 RH	S128QR	Kit 1	226.42	271.70
*1200 x 900 LH	S129QL	Kit 1	267.16	320.59
*1200 x 900 RH	S129QR	Kit 1	267.16	320.59

This product is handed – please choose L for Left Hand and R for Right Hand when ordering.
See Page 141 for Tray Panel Kit Information.





Touchstone-SR Tray

Design details



Graduated adjustable leg and easy-fit tray panel kit.



Adjustable leg system.



90mm fast flow waste, includes hair trap and chrome cover.



*Quadrant tray is handed – please choose L for Left Hand and R for Right Hand when ordering.



TOUCHSTONE-SR

We have carried out all the testing to give you and your family the peace of mind of showering in a safe environment and the splendour of this natural stone effect.

features

- » 10 Year Guarantee
- » 50mm high to achieve minimalist design
- » Available as low level or with tray panel kits for easy installation
- » Slip-resistant is manufactured into the coating and won't wear
- » Compatible 90mm fast flow waste also available
- » More than 30 sizes available

Rectangular & Square Trays

Size	Code	Tray Panel Kit	Price £ Exc. VAT	Price £ Inc. VAT
800 x 800	S80QAS	Kit 4	171.54	205.85
900 x 900	S90QAS	Kit 4	198.12	237.75
900 x 800	S980RTAS	Kit 4	251.75	302.10
1000 x 800	S108RTAS	Kit 4	259.98	311.98
1000 x 900	S109RTAS	Kit 4	269.95	323.94
1100 x 800	S118RTAS	Kit 4	269.95	323.94
1200 x 700	S127RTAS	Kit 4	269.95	323.94
1200 x 760	S1276RTAS	Kit 4	282.83	339.39
1200 x 800	S128RTAS	Kit 4	299.80	359.76
1200 x 900	S129RTAS	Kit 4	321.77	386.12
1400 x 700	S147RTAS	Kit 3	430.11	516.13
1400 x 800	S148RTAS	Kit 3	430.11	516.13
1400 x 900	S149RTAS	Kit 3	453.34	544.01
1500 x 760	S1576RTAS	Kit 3	504.64	605.56
1500 x 800	S158RTAS	Kit 3	504.64	605.56
1500 x 900	S159RTAS	Kit 3	531.18	637.42
1600 x 700	S167RTAS	Kit 3	563.10	675.72
1600 x 800	S168RTAS	Kit 3	563.10	675.72
1600 x 900	S169RTAS	Kit 3	591.24	709.49
1685 x 700	S177RTAS	Kit 3	610.00	732.00
1700 x 800	S178RTAS	Kit 3	684.16	820.99
1700 x 900	S179RTAS	Kit 3	736.94	884.32

*Waste is centred on 1700x800 & 1700x900 trays.

Quadrant Tray

Size	Code	Tray Panel Kit	Price £ Exc. VAT	Price £ Inc. VAT
800 x 800	S80QAS	Kit 2	187.66	225.19
900 x 900	S90QAS	Kit 2	209.84	251.81
*1000 x 800	S108QLAS LH	Kit 1	284.78	341.74
*1000 x 800	S108QRAS RH	Kit 1	284.78	341.74
*1200 x 800	S128QLAS LH	Kit 1	299.80	359.76
*1200 x 800	S128QRAS RH	Kit 1	299.80	359.76
*1200 x 900	S129QLAS LH	Kit 1	353.75	424.50
*1200 x 900	S129QRAS RH	Kit 1	353.75	424.50

This product is handed – please choose L for Left Hand and R for Right Hand when ordering.

Tray Panel Kit

Tray Panel Kit	Code	Price £ Exc. VAT	Price £ Inc. VAT
Kit 1	DRK1	131.96	158.35
Kit 2	DRK2	131.96	158.35
Kit 3	DRK3	131.96	158.35
Kit 4	DRK4	131.96	158.35

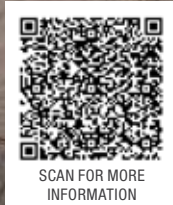

SCAN FOR MORE INFORMATION



MStone Tray

Design details



Graduated adjustable leg and easy-fit tray panel kit.



Adjustable leg system.



90mm fast flow waste, includes hair trap and chrome cover.



1. Top Acrylic capped ABS layer
2. Stone Resin
3. Bottom ABS layer (encapsulates the tray)



MSTONE

The MStone double skin stone resin tray is sleek and sophisticated in design. A highly engineered tray providing rigidity and strength, combined with a relatively low weight. MStone trays are ideal for 'low level' installation. Alternatively, you can raise your tray. In such cases you will need the MStone shower tray panel kit. MStone panel kits are available separately.

features

- » Double Skinned for added rigidity
- » 50mm high to achieve minimalist design
- » 135mm high including tray panel set
- » ABS capped acrylic sheets with anti-bacterial properties
- » Comes with 90mm fast flow waste
- » More than 30 sizes available
- » Available with tray panel kits
- » Shower tray lifetime guarantee *covers manufacturing defects only

Rectangular Tray (comes with MERLYN 90mm fast flow waste)

Size	Code	Tray Panel Kit*	Price £ Exc. VAT	Price £ Inc. VAT
900 x 760	D976RT	Kit 4	260.10	312.12
1000 x 800	D108RT	Kit 4	298.02	357.62
1100 x 760	D1176RT	Kit 4	329.33	395.19
1100 x 800	D118RT	Kit 4	316.75	380.09
1200 x 700	D127RT	Kit 4	312.98	375.57
1200 x 760	D1276RT	Kit 4	312.98	375.57
1200 x 800	D128RT	Kit 4	320.48	384.58
1200 x 900	D129RT	Kit 4	339.20	407.04
1400 x 800	D148RT	Kit 3	467.81	561.38
1400 x 900	D149RT	Kit 3	486.89	584.27
1500 x 700	D157RT	Kit 3	532.66	639.19
1500 x 800	D158RT	Kit 3	532.66	639.19
1500 x 900	D159RT	Kit 3	532.66	639.19
1600 x 800	D168RT	Kit 3	624.73	749.68
1600 x 900	D169RT	Kit 3	626.11	751.33
1685 x 700	D177RT	Kit 3	631.85	758.22
1680 x 760	D1776RT	Kit 3	631.85	758.22
*1700 x 800	D178RT	Kit 3	742.07	890.48

Tray Panel Kit (including Legs)

DRK3	Kit 3	131.96	158.35
DRK4	Kit 4	131.96	158.35

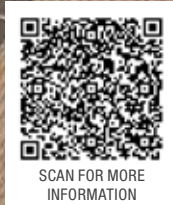

*Waste is centred for 1700 x 800 tray - D178RT

Tray Panel Kit (including Legs)

Code	Tray Panel Kit	Price £ Exc. VAT	Price £ Inc. VAT
DRK1	Kit 1	131.96	158.35

Waste Complete

DWAS	Kit 1	131.96	158.35
------	-------	--------	--------

White Waste Cap Option

DWASCAPWHT		18.70	22.43
------------	--	-------	-------

*Tray Panel Kit (Order Separately)
Please see page 94 for important tray information.



MSTONE

The MStone tray is capped with an easy to clean surface that provides a chemical resistant, anti-bacterial solution due to its ultra-smooth, non-porous surface.

Square Tray (comes with MERLYN 90mm fast flow waste)

Size	Code	Tray Panel Kit*	Price £ Exc. VAT	Price £ Inc. VAT
760	D76SQ	Kit 4	170.76	204.91
800	D80SQ	Kit 4	189.48	227.38
900	D76SQ	Kit 4	264.34	317.21

Tray Panel Kit (including Legs)

DRK4	Kit 4	131.96	158.35
------	-------	--------	--------

Quadrant Tray (comes with MERLYN 90mm fast flow waste)

Size	Code	Tray Panel Kit*	Price £ Exc. VAT	Price £ Inc. VAT
800	D80Q	Kit 2	241.89	290.27
900	D90Q	Kit 2	264.34	317.21
1000	D100Q	Kit 5	343.62	412.34

Tray Panel Kit (including Legs)

DRK2	Kit 2	131.96	158.35
DRK5	Kit 5	131.96	158.35

Offset Quadrant Tray (comes with MERLYN 90mm fast flow waste)

Size	Code	Tray Panel Kit*	Price £ Exc. VAT	Price £ Inc. VAT
900 x 760	D976Q L	Kit 1	353.65	424.39
900 x 760	D976Q R	Kit 1	353.65	424.39
1000 x 800	D108Q L	Kit 1	339.20	407.04
1000 x 800	D108Q R	Kit 1	339.20	407.04
1200 x 800	D128Q L	Kit 1	356.01	427.22
1200 x 800	D128Q R	Kit 1	356.01	427.22
1200 x 900	D129Q L	Kit 1	374.72	449.66
1200 x 900	D129Q R	Kit 1	374.72	449.66

MStone Tray

Tray types



Rectangular Tray



Rectangular Tray with centred waste



Square tray



Quadrant Tray



Offset Quadrant Tray

Image shown as Left Handed (L) Please choose L for Left or R for Right when ordering.



Left Handed (L)



Right Handed (R)

*Tray Panel Kit (Order Separately)
Please see page 94 for important tray information.



Rectangular Tray - Shown as right hand



Square Tray - Shown as right hand



MERLYN UPSTAND®

Upstands are designed with an additional vertical lip around their perimeter that is tiled over to provide further leak prevention.

features

- » Single skinned with 4 upstands
- » 50mm high (63mm with upstand)
- » 135mm high with tray panel set (148mm high including upstand)
- » ABS capped acrylic sheet with anti-bacterial properties
- » Available with 90mm branded fast flow waste (optional extra)
- » Available with tray panel kits (optional extra)

Rectangular Tray - with 4 Upstands

Size	Code	Tray Panel Kit*	Price £ Exc. VAT	Price £ Inc. VAT
900 x 760	S976RTUP	Kit 4	242.12	290.54
1000 x 800	S108RTUP	Kit 4	255.23	306.28
1000 x 800**	S108RTUPCW	Kit 4	255.23	306.28 NEW
1200 x 760	S1276RTUP	Kit 4	277.65	333.18
1200 x 800	S128RTUP	Kit 4	294.34	353.21
1200 x 800**	S128RTUPCW	Kit 4	294.34	353.21 NEW
1200 x 900	S129RTUP	Kit 4	315.86	379.03
1300 x 800	S138RTUP	Kit 4	402.03	482.44
1400 x 800	S148RTUP	Kit 4	412.90	495.48
1500 x 800	S158RTUP	Kit 4	425.00	510.00
1700 x 800	S178RTUP	Kit 4	587.32	704.78

**Waste is centred on the 1000x800 / 1200x800. See page 147

Square Tray - with 4 Upstands

Size	Code	Tray Panel Kit*	Price £ Exc. VAT	Price £ Inc. VAT
760	S76SQUP	Kit 4	170.76	204.91
800	S80SQUP	Kit 4	189.48	227.38
900	S90SQUP	Kit 4	264.34	317.21
900**	S90SQUPCW	Kit 2	242.12	290.54 NEW

**Waste is centred on the 900 tray

Optional Extra - Rectangle Tray Panel Kit (including Legs)

Code	Tray Panel Kit*	Price £ Exc. VAT	Price £ Inc. VAT
DRK4	Kit 4	131.96	158.35

Waste Complete Only

Code	Price £ Exc. VAT	Price £ Inc. VAT
DWAS	39.06	46.87

*Tray Panel Kit (Order Separately)

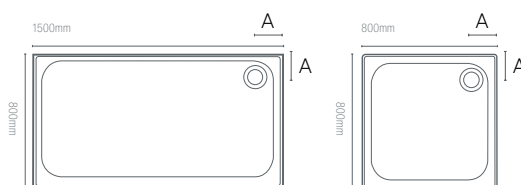

Waste position A = 148MM

Waste position A = 148MM

Design details



Adjustable legs & tray panel kit



Graduated adjustable leg system



Optional extra 90mm fast flow waste



13mm high upstand

Product Information

We have produced this product section to help you with your purchasing decision. For further information please contact your local stockist, details of which can be found at www.merlynshowering.com

Product information

All products are manufactured in accordance with EN14428 and utilise toughened safety glass to EN 12150.

All shower trays are manufactured in accordance with EN14527.

All doors feature adjustable wall profiles to compensate for out-of-true walls and have micro adjustment features for fine tuning to obtain a perfect fit and operating action.

All enclosures, wetrooms and panels are Power Shower approved – will retain water under normal showering conditions.

Water retention is maintained in all products under normal showering conditions.

A selection of MERLYN enclosures are frameless in design. Spray/mist may escape therefore we would recommend use of these enclosures with tiled floors.

Opened cartons can not be returned. Returns carry a €40 box charge or €60 per unit where the sale is less than 30 days old. Returns over 30 days old will not be accepted.

All products are supplied complete with full installation instructions and the necessary fixings.

Check with your dealer for accurate matching of material samples. Product descriptions do not imply the use of precious or valuable materials.

Our policy of reviewing product design and development on a regular basis means MERLYN reserve the right to change product specifications and prices without notice.

Only shower enclosures, panels, Truestone shower trays and bath screens are covered by the Lifetime Guarantee. Please contact the MERLYN sales team for more details.

Glass shattering and parts subject to wear are not covered by the Lifetime Guarantee.

For full details on all product ranges please contact MERLYN Showering on 0808 1011429 or log onto www.merlynshowering.com.

Trays shown in this catalogue are for illustrative purposes only.

Images are for illustration purposes only.

The colours and finishes shown in the catalogue are as accurate as possible within the limits of the printing process. The positioning of all showering heads in the brochure is for illustrative purposes only.

All descriptions, specifications and particulars contained in this brochure are intended merely to represent a general idea of the products described herein and none of these form part of any contract to give rise to any independent or collateral liability upon the company.

Cleaning

- » It is important to clean your MERLYN shower door and tray after every use. Wipe down all the glass and metal parts with a soft cloth.
- » Do not allow lime scale to build up in hard water areas.
- » Ensure that any residual water on the glass is removed after every use.
- » Clean the glass regularly using soapy water.
- » Do not use abrasive products on any surfaces.
- » Install the enclosure in a well ventilated area.

Information and maintenance

Always read the instructions on the packaging, chrome is vulnerable to acid attack and some strong household cleaners including strong disinfectants, denture cleaners, hair dyes, wine making chemicals and photographic chemicals may contain acid. These materials may have a varying effect on the surface from black spots/streaks (which cannot be removed) to pitting the surface. Contact with these materials should be avoided.

Important shower tray information

It is up to the designer or installer to ensure that the tray and enclosure combination is arranged in such a way that water retention meets the customers needs.

- » The waste has the capacity to carry away 29L/Min. High powered systems may exceed this. Please check with the manufacturer.
- » Please ensure that the shower head is not positioned directly over the waste as this may restrict water flow rate.
- » Please ensure that the colour and size of shower tray are as per your order before installation.
- » You must inspect the product thoroughly before installation. Fitting the product is acceptance of quality.
- » The trays are handmade from natural material. Please allow for height variances due to manufacturing tolerances.
- » For open ended shower screens please consult your installer.
- » Shower trays must be fitted as per the fitting instruction. Deviation from the pre installation checks or fitting installation will void the guarantee.
- » When wet, the surface of the majority of shower trays will show an increase in the potential for slipping. This is particularly the case when soap, shampoo, bath oil etc. are used. It is important that designers, installers and users are aware of this.

Important

Although shower door and enclosure sizes are related to tray sizes it is important to note that most shower trays are tiled down to the rim, often over an 'up-stand'. The finished installation space may be less than the nominal tray size. MERLYN shower units are made to suit this remaining space.

Tray Finish min-max

The Tray Finish applies when fitting a door and a tray. These are the minimum and maximum dimensions that a shower door or enclosure will fit using standard wall profiles.

Tray finish

To find the correct Tray Finish dimension:

In a recess: Measure from the finished, tiled wall to the opposite finished, tiled wall.

In a corner: Measure from the finished, tiled wall to the edge of the tray.

Note: If the wall/walls are leaning in, this will further reduce your Tray Finish.

Adjustment

This is the min and max adjustment of the actual enclosure. These are the adjustment dimensions of the actual door excluding the tray. Therefore, these are the dimensions to follow when installing a enclosure in a wetroom application without a tray.

The guide below may be helpful in taking measurements to determine the shower door or enclosure size required. Dimensions given in this publication are in millimetres, are approximate and may vary with adjustment. They are subject to change without notice.

Please note that when a tray is fitted it is essential that the tray is level before any doors or enclosures are fitted.

Recess Location

Take the measurements after the tray is installed and the walls are tiled.

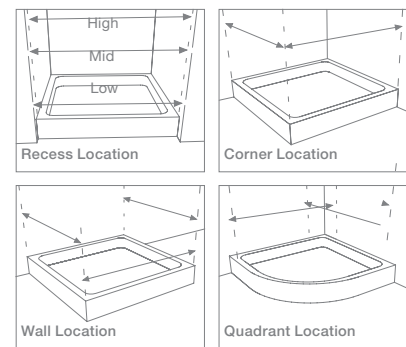

Bath Screens

- » MERLYN Bath Screens are not designed to fit on baths with stepped fronts, roll top rims or integral soap dishes.
- » Fitting of screen on baths which have raised head rests or shapes is not recommended.
- » There must be no items causing obstruction with the seal and bath, as any of the above may cause leaks.
- » When choosing your Bath Screen, please ensure that if your bath has bath handles, they do not interfere with the bath rim area where your screen will be placed.
- » When choosing an in-swing or folding Bath Screen, please ensure your swing area is not interfering with any brassware or internal shower features. Similarly, when choosing an out-swing, please ensure the out-swing area is free from any obstructions.
- » It is recommended the shower head position is situated on the same wall to which the Bath Screen is fixed and in the centre of the shower area.

Extension Profiles

10 Series Sliding Door

Code	Height	Price £ Exc. VAT	Price £ Inc. VAT
M108EXTSL	1950	118.52	142.22

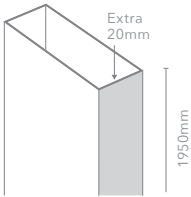

Series 10 extension profile: extra 20mm. Sliding Door can only be used with one extension profile.

10 Series Pivot - Hinged Side

Code	Height	Price £ Exc. VAT	Price £ Inc. VAT
M108EXTPVH	2025	118.52	142.22

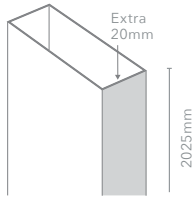

Series 10 extension profile; extra 20mm. Series 10 Pivot Hinge Side extension to be fitted on the same side as the door hinge.

10 Series Pivot - Closing Side

Code	Height	Price £ Exc. VAT	Price £ Inc. VAT
M108EXTPV	2000	118.52	142.22

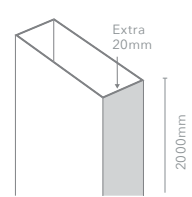

Series 10 extension profile: extra 20mm. Series 10 Pivot Side Panel extension to be fitted on the closing post, Inline Panel or Side Panel side.

10 Series Quadrant

Code	Height	Price £ Exc. VAT	Price £ Inc. VAT
M108EXTQU	1850	118.52	142.22

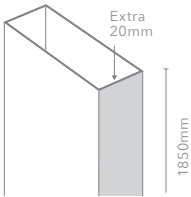

Series 10 extension profile: extra 20mm

8 Series Frameless - Hinge & Quadrant Doors

Code	Height	Price £ Exc. VAT	Price £ Inc. VAT
A0614A0	2000	97.60	117.12

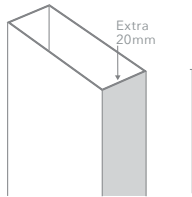

8 Series Frameless extension profile: extra 20mm.

8 Series Frameless - Hinged Bifold Door

Code	Height	Price £ Exc. VAT	Price £ Inc. VAT
M8FBEXT20	1950	91.57	109.89

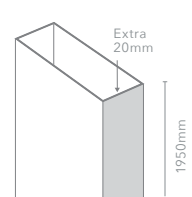

8 Series Frameless extension profile: extra 20mm.

8 Series Frameless - Pivot / Pivot & Inline

Code	Height	Price £ Exc. VAT	Price £ Inc. VAT
M8FBEXT20	1950		

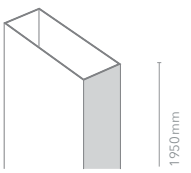

8 Series

Code	Height	Price £ Exc. VAT	Price £ Inc. VAT
M8EXT20	1950		

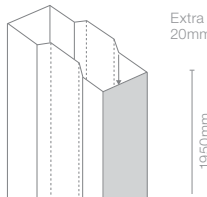

8 Series extension profile: extra 20mm.

6 Series Frameless

Code	Height	Price £ Exc. VAT	Price £ Inc. VAT
M8EXT20	2000	93.81	112.57

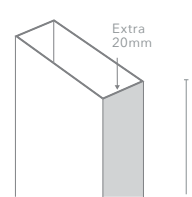

6 Series Frameless extension profile: extra 20mm.

6 Series

Code	Height	Price £ Exc. VAT	Price £ Inc. VAT
M6EXT	1900	82.50	99.00

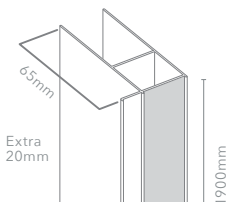

Series 6 extension profile: extra 20mm. No extension profile available for wetroom panels.

Essence Framed Extension Profile

Code	Height	Price £ Exc. VAT	Price £ Inc. VAT
DWH14B0	1900	94.56	113.48

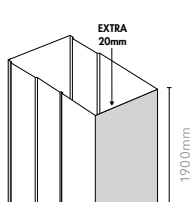

Essence Sliding & Quadrant Doors

Code	Height	Price £ Exc. VAT	Price £ Inc. VAT
A0114E0	2000	94.56	113.48

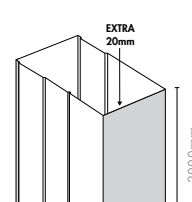

Essence Hinge & Inline Doors

Code	Height	Price £ Exc. VAT	Price £ Inc. VAT
A0114D0	2000	94.56	113.48

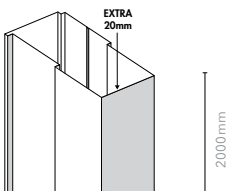

Express Extension Profile

Code	Height	Price £ Exc. VAT	Price £ Inc. VAT
A0314B0	1900	90.34	108.40

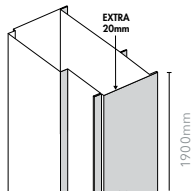

Source Extension Profile

Code	Height	Price £ Exc. VAT	Price £ Inc. VAT
A1214C0	1850	68.33	82.00

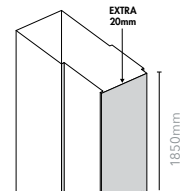

MERLYN IQ Sliding Door

Code	Height	Price £ Exc. VAT	Price £ Inc. VAT
KAE1	1900	83.00	99.60

MERLYN IQ Side Panel Extension

KAE3	1900	83.00	99.60
------	------	-------	-------

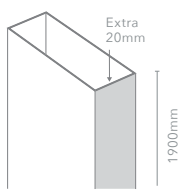

MERLYN IQ Pivot / Bifold Door

Code	Height	Price £ Exc. VAT	Price £ Inc. VAT
KAE2	1900	83.00	99.60

MERLYN IQ Side Panel Extension

KAE3	1900	83.00	99.60
------	------	-------	-------

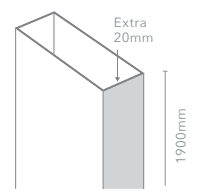

8 | series *Inline Panel - Space Solutions*

Our 8 Series range includes the option of additional Inline Panels to ensure the 8 Series can be used in any space from 650mm to 1900mm. Simply choose the adjustment for your space and we will create the ideal combination for you.

Inline Panels

8 Series Inline Panels			
Adjustment / Wetroom - Min-Max	Code*	Price £ Exc. VAT	Price £ Inc. VAT
150	M8P140	365.50	438.60
210	M8P2200	382.72	459.26

Infold Door and Inline Panel

Infold Door and Inline Panel					
Size	Size of Door Supplied	Code	Inline Panel Supplied	Price £ Exc. VAT	Price £ Inc. VAT
650-690	700	M84401	-	1052.87	1263.44
670-710	700	M84401H	EXT.	1142.50	1371.00
710-750	760	M84410	-	1070.43	1284.51
750-790	800	M84411	-	1091.45	1309.74
780-840	700	M84401P1H	150	1418.35	1702.01
840-900	700	M84401P2H	210	1435.57	1722.69
850-890	900	M84421	-	1107.06	1328.48
900-960	760	M84410P1H	210	1453.13	1743.76
950-990	1000	M84431	-	1496.77	1796.12
940-1000	800	M84411P2H	210	1474.17	1769.00
980-1040	900	M84421P1H	150	1472.56	1767.08
1040-1100	900	M84421P2H	210	1489.79	1787.75
1080-1140	1000	M84431P1H	150	1570.53	1884.64
1140-1200	1000	M84431P2H	210	1587.75	1905.29

Please add 20mm to size when using with a Side Panel.
Optional Side Panel available: See Page 46.

Hinge Door and Inline Panel

Hinge Door and Inline Panel					
Size	Size of Door Supplied	Code	Inline Panel Supplied	Price £ Exc. VAT	Price £ Inc. VAT
650-690	700	M81201	-	993.87	1192.64
670-710	700	M81201H	EXT.	1083.51	1300.21
710-750	760	M81210	-	1376.59	1651.91
750-790	800	M81211	-	1378.57	1654.29
780-840	700	M81201PH	150	1142.50	1371.00
840-900	700	M81210P1H	210	1376.59	1651.91
850-890	900	M81221	-	1468.00	1761.59
900-960	760	M81210P2H	210	1378.57	1654.29
950-990	1000	M81231	-	1532.73	1839.28
940-1000	800	M81211PH	210	1378.57	1654.29
980-1040	900	M81221P1H	150	1468.00	1761.59
1040-1100	900	M81221P2H	210	1485.21	1782.25
1080-1140	1000	M81231P1H	150	1532.73	1839.28
1140-1200	1000	M81231P2H	210	1549.95	1859.93

Please add 20mm to size when using with a Side Panel.
Optional Side Panel available: See Page ???.

Sliding Door and Inline Panel

Sliding Door and Inline Panel					
Size	Size of Door Supplied	Code	Inline Panel Supplied	Price £ Exc. VAT	Price £ Inc. VAT
950-990	1000	M88231	-	1087.95	1305.53
1050-1090	1100	M88251	-	1087.95	1305.53
1080-1140	1000	M88231P1H	150	1453.46	1744.15
1140-1200	1000	M88231P2H	210	1470.67	1764.81
1150-1190	1200	M88241	-	1087.95	1305.53
1180-1240	1100	M88251P1H	150	1453.46	1744.15
1240-1300	1100	M88251P2H	210	1470.67	1764.81
1280-1340	1200	M88241P1H	150	1453.46	1744.15
1340-1400	1200	M88241P2H	210	1470.67	1764.81
1250-1290	1300	M88240	-	1322.51	1587.01
1350-1390	1400	M88291	-	1375.37	1650.45
1370-1450	1100	M88251H	150+210	1836.17	2203.41
1450-1490	1500	M88261	-	1423.13	1707.75
1480-1540	1400	M88291P1H	150	1740.86	2089.03
1540-1600	1400	M88291P2H	210	1758.08	2109.69
1550-1590	1600	M88271	-	1440.68	1728.81
1580-1640	1500	M88261P1H	150	1788.64	2146.37
1640-1700	1500	M88261P2H	210	1805.85	2167.03
1650-1690	1700	M88281	-	1510.87	1813.04
1680-1740	1600	M88271P1H	150	1806.16	2167.39
1740-1800	1600	M88271P2H	210	1823.39	2188.07
1780-1840	1700	M88281P1H	150	1876.37	2251.64
1840-1900	1700	M88281P2H	210	1893.58	2272.30

Please add 20mm to size when using with a Side Panel.
Optional Side Panel available: See Page 42.

6 | series *Inline Panel - Space Solutions*

Our 6 Series range includes the option of additional Inline Panels to ensure the 6 Series can be used in any space from 670mm to 1915mm. Simply choose the adjustment for your space and we will create the ideal combination for you.

Inline Panels

6 Series Inline Panels			
Adjustment / Wetroom - Min-Max	Code*	Price £ Exc. VAT	Price £ Inc. VAT
140	M6I125	346.57	415.89
215	M6I200	363.97	436.76

Sliding Door and Inline Panel

Sliding Door and Inline Panel					
Size	Size of Door Supplied	Code	Inline Panel Supplied	Price £ Exc. VAT	Price £ Inc. VAT
950-1000	1000	M68231	-	776.01	931.22
1050-1100	1100	M68251	-	776.01	931.22
1065-1140	1000	M68231P1H	140	1299.08	1558.89
1140-1215	1000	M68231P2H	215	1316.48	1579.78
1150-1200	1200	M68241	-	776.01	931.22
1165-1240	1100	M68251P1H	140	1122.58	1347.09
1240-1315	1100	M68251P2H	215	1139.98	1367.98
1265-1340	1200	M68241P1H	140	1122.58	1347.09
1340-1415	1200	M68241P2H	215	1139.98	1367.98
1350-1400	1400	M68291	-	1299.08	1558.89
1360-1460	1100	M68251PPH	140+215	1486.55	1783.86
1450-1500	1500	M68261	-	1014.45	1217.34
1465-1540	1400	M68291P1H	140	1361.01	1633.22
1540-1615	1400	M68291P2H	215	1316.48	1579.78
1550-1600	1600	M68271	-	1071.75	1286.10
1565-1640	1500	M68261P1H	140	1361.01	1633.22
1640-1715	1500	M68261P2H	215	1378.43	1654.11
1650-1700	1700	M68281	-	1071.75	1286.10
1665-1740	1600	M68271P1H	140	1418.31	1701.97
1740-1815	1600	M68271P2H	215	1435.74	1722.89
1765-1840	1700	M68281P1H	140	1418.31	1701.97
1840-1915	1700	M68281P2H	215	1435.74	1722.89

Please add 20mm to size when using with a Side Panel.
Optional Side Panel available: See Page 58.

Pivot Door and Inline panel

Pivot Door and Inline panel					
Size	Size of Door Supplied	Code	Inline Panel Supplied	Price £ Exc. VAT	Price £ Inc. VAT
670-720	700	M61201 N	-	559.01	670.82
690-740	700	M61201H	EXT	641.52	769.83
740-790	760/800	M61211 N	-	629.37	755.25
785-860	700	M61201P1H	140	905.59	1086.70
850-900	900	M61221 N	-	659.79	791.75
860-935	700	M61211P1H	215	923.00	1107.60
930-1005	760/800	M61211P2H	215	993.34	1192.01
950-1000	1000	M61231 N	-	695.50	834.60
965-1040	900	M61221P1H	140	1006.38	1207.65
1040-1115	900	M61221P2H	215	1023.78	1228.54
1065-1140	1000	M61231P1H	140	1042.05	1250.46
1140-1215	1000	M61231P2H	215	1059.45	1271.34

Please add 20mm to size when using a Side Panel
Optional Side Panel available: See page 59.

Bifold Door and Inline panel

Bifold Door and Inline panel					
Size	Size of Door Supplied	Code	Inline Panel Supplied	Price £ Exc. VAT	Price £ Inc. VAT
670-720	700	M67201 N	-	867.91	1041.49
690-740	700	M67201H	EXT	950.43	1140.52
740-790	760/800	M67211 N	-	867.91	1041.49
785-860	700	M67201PH	140	1214.48	1457.38
850-900	900	M67221 N	-	930.28	1116.34
860-935	700	M67201P2H	215	1231.90	1478.28
930-1005	760/800	M67211P2H	215	1231.90	1478.28
950-1000	1000	M67231 N	-	978.41	1174.09
965-1040	900	M67221P1H	140	1276.84	1532.21
1040-1115	900	M67221P2H	215	1294.25	1553.10
1065-1140	1000	M67231P1H	140	1324.97	1589.97
1140-1215	1000	M67231P2H	215	1342.38	1610.85

Please add 20mm to size when using with a Side Panel.
Optional Side Panel available: See Page 60.

IONIC Express *Inline Panel - Space Solutions*

Our Ionic express range includes the option of additional Inline Panels to ensure the 8 Series can be used in any space from 650mm to 1900mm. Simply choose the adjustment for your space and we will create the ideal combination for you.

Pivot Door and Inline Panels

Pivot Door and Inline Panel					
Size	Code	Door Size mm	Inline Panel Size mm	Price £ Exc. VAT	Price £ Inc. VAT
650-690	A0306A0	700	-	549.43	659.32
670-710	A030001H	700	EXT.	639.77	767.72
710-750	A0306B0	760	-	549.43	659.32
750-790	A0306D0	800	-	549.43	659.32
780-840	A030002H	700	150	879.50	1055.40
840-900	A030003H	700	210	879.50	1055.40
850-890	A0306E0	900	-	632.36	758.84
900-960	A030004H	760	210	879.50	1055.40
950-990	A0306G0	1000	-	696.88	836.25
940-1000	A030005H	800	210	879.50	1055.40
980-1040	A030006H	900	150	962.40	1154.88
1040-1100	A030007H	900	210	962.40	1154.88
1080-1140	A030008H	1000	150	1026.92	1232.31
1140-1200	A030009H	1000	210	1026.92	1232.31

Sliding Door and Inline Panels

Sliding Door and Inline Panel					
Size	Code	Door Size mm	Inline Panel Size mm	Price £ Exc. VAT	Price £ Inc. VAT
950-990	A0304A0	1000	-	643.50	772.20
1050-1090	A0304B0	1100	-	643.50	772.20
1080-1140	A030016H	1000	150	973.54	1168.24
1140-1200	A030017H	1000	210	973.54	1168.24
1150-1190	A0304C0	1200	-	643.50	772.20
1180-1240	A030018H	1100	150	973.54	1168.24
1240-1300	A030019H	1100	210	973.54	1168.24
1280-1340	A030020H	1200	150	973.54	1168.24
1340-1400	A030021H	1200	210	973.54	1168.24
1350-1390	A0304DH	1400	-	827.87	993.44
1370-1450	A030022H	1100	150+ 210	1303.58	1564.30
1450-1490	A0304GH	1500	-	881.27	1057.52
1480-1540	A030023H	1400	150	1157.92	1389.50
1540-1600	A030024H	1400	210	1157.92	1389.50
1580-1640	A030025H	1500	150	1211.33	1453.59
1640-1700	A030026H	1500	210	1211.33	1453.59
1650-1690	A0304HH	1700	-	912.72	1095.26
1670-1750	A030027H	1400	150 + 210	1487.98	1785.57
1730-1810	A030028H	1400	210 x 2	1487.98	1785.57
1780-1840	A030029H	1700	150	1242.78	1491.34
1840-1900	A030030H	1700	210	1242.78	1491.34

Bifold Door and Inline Panels

Bifold Door and Inline Panel					
Size	Code	Door Size mm	Inline Panel Size mm	Price £ Exc. VAT	Price £ Inc. VAT
710-750	A0300B0	760	-	615.90	739.08
750-790	A0300C0	800	-	615.90	739.08
850-890	A0300D0	900	-	658.18	789.81
900-960	A030010H	760	210	945.96	1135.15
950-990	A0300E0	1000	-	765.11	918.13
940-1000	A030011H	800	210	879.50	1055.40
980-1040	A030012H	900	150	988.20	1185.84
1040-1100	A030013H	900	210	988.20	1185.84
1080-1140	A030014H	1000	150	1026.92	1232.31
1140-1200	A030015H	1000	210	1095.17	1314.20

Tray Waste Positions

Truestone Trays

Shape	Size	Waste Position A, mm	Waste Position B, mm
Square		A	B
	900 x 900	270	450

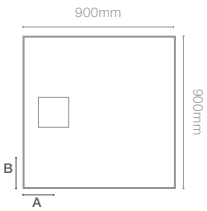

Rectangle	A	B
1000 x 800	270	400
1200 x 800	250	400
1200 x 900	250	450
1400 x 800	350	400
1400 x 900	350	450
1500 x 800	400	400
1500 x 900	400	450
1600 x 800	450	400
1600 x 900	450	450
1600 x 900	450	450
1700 x 800	500	400
1700 x 900	500	450



Quad	A	B
900 x 900	270	270

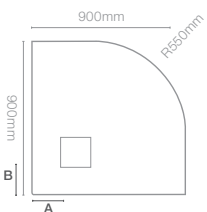

Offset Quad	A	B
1000 x 800	270	270
1200 x 900	270	270

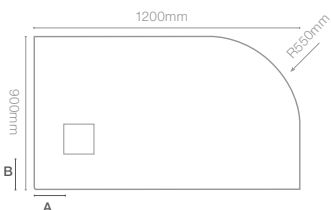

Level25 & Level25 SR Trays

Shape	Size	Waste Position A, mm	Waste Position B, mm
Square		A	B
	900 x 900	121.5	450

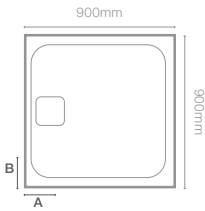

Rectangle	A	B
1000 x 800	121.5	500
1000 x 900	121.5	500
1100 x 800	121.5	550
1100 x 900	121.5	550
1200 x 700	121.5	550
1200 x 760	121.5	600
1200 x 800	121.5	600
1200 x 900	121.5	600
1300 x 800	121.5	650
1300 x 900	121.5	650
1400 x 760	121.5	700
1400 x 800	121.5	700
1400 x 900	121.5	700
1500 x 800	121.5	750
1500 x 900	121.5	750
1600 x 800	121.5	800
1600 x 900	121.5	800
1700 x 760	121.5	850
1700 x 800	121.5	850
1700 x 900	121.5	850

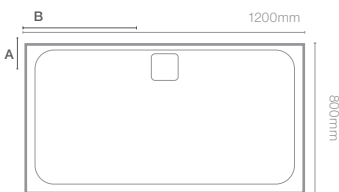

Quad	A	B
900 x 900	121.5	450

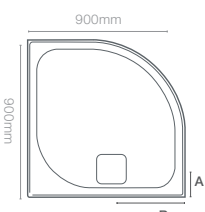

Offset Quad	A	B
1200 x 900	121.5	600

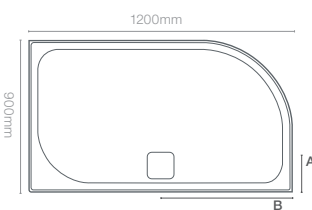

Upstand Trays

Shape	Size	Waste Position A, mm	Waste Position B, mm
Square		A	B
	760	148	148
	800	148	148
	900	148	148

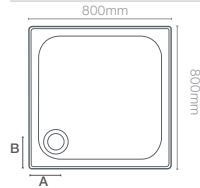

Rectangle	A	B
900 x 760	148	148
1000 x 800	148	148
1200 x 760	148	148
1200 x 800	148	148
1200 x 900	148	148
1300 x 800	148	148
1400 x 800	148	148
1500 x 800	148	148

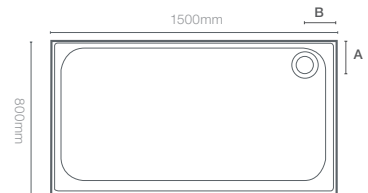

Rectangle & Square (centre waste)	A	B
900 x 900	148	450
1000 x 800	148	500
1200 x 800	148	600
1700 x 800	148	148

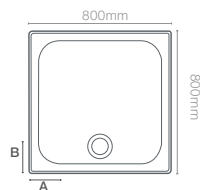
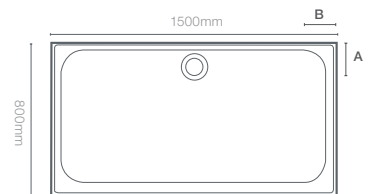

Tray Waste Positions

Touchstone Trays

Shape	Size	Waste Position A, mm	Waste Position B, mm
Square	760	148	148
	800	148	148
	900	148	148

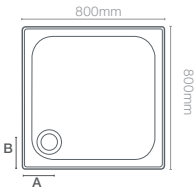

Rectangle	A	B
800 x 700	148	148
800 x 760	148	148
900 x 700	148	148
900 x 760	148	148
900 x 800	148	148
1000 x 700	148	148
1000 x 760	148	148
1000 x 800	148	148
1000 x 900	148	148
1100 x 800	148	148
1200 x 700	148	148
1200 x 760	148	148
1200 x 800	148	148
1200 x 900	148	148
1300 x 800	148	148
1400 x 700	148	148
1400 x 760	148	148
1400 x 800	148	148
1400 x 900	148	148
1500 x 700	148	148
1500 x 760	148	148
1500 x 800	148	148
1500 x 900	148	148
1600 x 700	148	148
1600 x 800	148	148
1600 x 900	148	148
1685 x 700	148	148
1680 x 760	148	148
1600 x 900	148	148
1685 x 700	148	148
1700 x 800	130	850
1700 x 900	130	850
1800 x 800	130	850

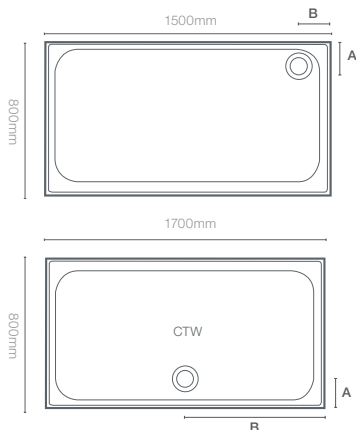

Waste is centred for 1700 x 800 / 1700 x 900 & 1800 x 800 trays

Touchstone Trays - Continued

Shape	Size	Waste Position A, mm	Waste Position B, mm
Quad	800	250	130
	900	350	130

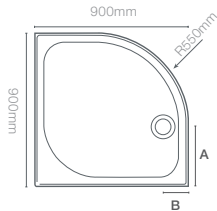

Offset Quad	A	B
1000 x 800	350	130
1200 x 800	450	130
1200 x 900	450	130

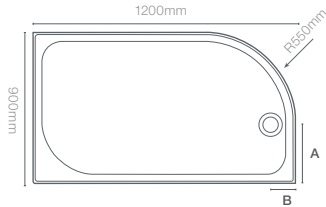

Left Handed (L) Right Handed (R)



Product is handed. Please choose L for Left or R for Right when ordering

MStone Trays

Shape	Size	Waste Position A, mm	Waste Position B, mm
Square	760	148	148
	800	148	148
	900	148	148

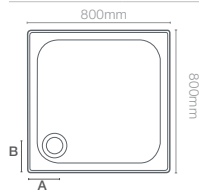

Rectangle	A	B
900 x 760	148	148
1000 x 800	148	148
1100 x 760	148	148
1100 x 800	148	148
1200 x 700	148	148
1200 x 760	148	148
1200 x 800	148	148
1200 x 900	148	148
1400 x 800	148	148
1400 x 900	148	148
1500 x 700	148	148
1500 x 800	148	148
1500 x 900	148	148
1600 x 800	148	148
1600 x 900	148	148
1685 x 700	148	148
1680 x 760	148	148
1700 x 800	850	130

MStone Trays - Continued

Shape	Size	Waste Position A, mm	Waste Position B, mm
Quad	800	250	130
	900	350	130
	1000	350	130

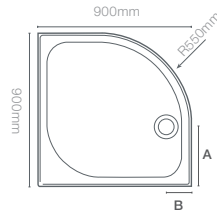

Offset Quad	A	B
900 X 760	250	130
1000 X 800	350	130
1200 X 800	450	130
1200 X 900	450	130

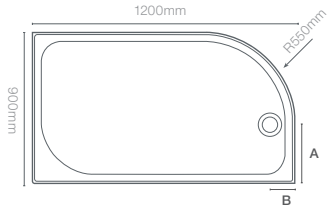

Left Handed (L) Right Handed (R)



Product is handed. Please choose L for Left or R for Right when ordering

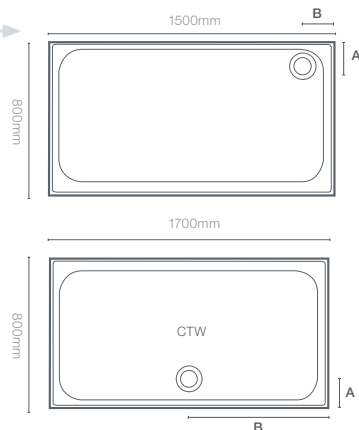

Waste is centred for 1700 x 800, 1700 x 900 and 1800 x 800 trays

Mershield Stayclear



MERSHIELD™
STAYCLEAR

Without Mershield Stayclear™

NATURAL GLASS SURFACE

With Mershield Stayclear™

GLASS SURFACE WITH MERSHIELD STAYCLEAR™ COATING

Mershield Stayclear™ creates a smooth layer over the surface of natural glass, lowering surface friction, making it easier for water, soap and lime deposits to run off the glass.

MERLYN treats every product in the Series Collection with a special protective coating to ensure the glass maintains its sparkle. This comes as standard as part of our on-going commitment to service.

Mershield Stayclear™ acts as a protective coating which when applied to glass, helps the glass to remain shiny and new without the need for tiresome cleaning.

When cleaned correctly it helps prevent the build up of lime-scale and soap deposits making the shower glass "easy to clean". Please see tips for keeping the glass in pristine condition on page 144.



LIFETIME
GUARANTEE

MERLYN Lifetime Guarantee

MERLYN is committed to developing products that meet the highest demands in terms of design, performance and quality. Due to our extreme confidence in our products and our unrelenting desire to deliver only the highest level of service, we have created the MERLYN Lifetime Guarantee.

MERLYN shower enclosures are crafted and engineered for a lifetime.

For more about our MERLYN Lifetime Guarantee, contact our MERLYN customer service team on **0808 1011 429**

REGISTER your new MERLYN product for the Lifetime Guarantee - log on to **www.merlynshowering.com** and fill in your information.

UKCA, CE & EN Information

The UKCA (UK Conformity Assessment) mark on MERLYN enclosures is the new standard marking for products on the market in Great Britain (England, Wales and Scotland). It is a declaration that the product complies with GB designated standards.

The CE markings on MERLYN enclosures is a declaration that the product complies with the essential requirements of the relevant European health, safety and environmental protection legislation.

EU and GB legislation requires manufacturers to display either the UKCA mark for Great Britain and a CE mark for the EU and Northern Ireland on their product or packaging. It is an offence to place a product on the relevant market without a UKCA for Great Britain or CE marking for the EU market.

The manufacturer is legally responsible for ensuring that the product conforms to the requirements of both directives.

The European Commission thus refers to the CE marking as a "Passport" which allows products to be freely circulated within the EU single market. The UKCA marking allows products to move freely within Great Britain.

Often consumers will consider the UKCA and CE markings on a product as an indication of conformance to laid down minimum standards and therefore, a minimum level of safety which other products may lack. Both markings are often seen by consumers as a "Symbol of Safety."



UKCA	
CE	
UK Distributor: Merlyn (a division of NG4L), Ladysfield House, Station Rd, Wilmsham, Chester, SK9 1BU.	Manufacturer: Merlyn Industries Limited, Unit 8, Parnockinch Ind. Estate, Kilkenny, Ireland, R95 HPY 1.
19	
UKCA DOP: UKCATZ1.1 CE DOP: CETZ1.1	
Product Code here (MER13)	
PH	
EN 14428	
CAIRIDA	

M 19100	
1 DOOR QUADRANT SHOWER ENCLOSURE	
HEIGHT	1850
SIZE ADJUSTMENT	900 875-900
COLOR	CHROME
GLASS	CLEAR
CODE	V04HC00
WEIGHT	47KG
PD	70004
0035-0402	



MERLYN invests heavily in its product development and as such guarantees that its glass fully complies with regulations and is manufactured in accordance with BS EN 14428. The rigorous testing of the glass ensures that the endurance, stability and water retention criteria meet high industry standards.

New GB, EU and NI label

ISO Certification

MERLYN has implemented an Integrated Management System comprising of Quality Management, Environmental Management and Occupational Health and Safety Management. An Integrated Management System ensures the seamless integration of several different standards into a common system that meets the requirements of each of these standards. These certifications are proof of MERLYN's credibility but also to instil confidence in our potential consumers that MERLYN will keep its promises.





MERLYN™

Unit 8, PurcellSinch Industrial Estate, Dublin Road, Kilkenny, Ireland, R95 HP71.

T 0808 1011 429 / F 0808 1011 428

E sales@merlyn.ie / technical@merlyn.ie

www.merlynshowering.com

