

Ab
ambiance bain



FITTED

FURNITURE

RETAIL PRICES IN £
INCLUDING VAT
JANUARY 2023

RETAIL PRICES IN £ INCLUDING VAT

CONTENTS

WC UNITS	page 2-3
BIDET UNITS	page 4
BASIN UNITS	page 5-7
BASE UNITS	page 8-11
HI-LINE UNITS	page 12-15
50CM DEEP UNITS	page 16
60CM DEEP UNITS	page 17
TALL UNITS	page 18
HI-LINE TALL UNITS	page 19
WALL UNITS	page 20-21
PANORAMIC MIRRORS & WALL SHELVING PANELS	page 22
LIGHT PELMETS	page 23
SMO™ WORKTOPS	page 24-27
SOLID SURFACE WORKTOPS	page 28
BATH PANELS	page 29
MIRRORS & LIGHTS	page 30-31
SPARE FASCIAS	page 32-35
ANCILLARY ITEMS	page 36-37
TECHNICAL INFORMATION	page 38-39
HANDLES & FINISHES	page 40-41



01827 839259

This price list catalogue is available electronically on EQ Pricing and Virtual Worlds CAD design packages.

To discover how Partner software can help you with Ambiance bain product sales and pricing please contact each company directly.



01908 663848



To view our Terms and Conditions visit our website
www.ambiancebain.co.uk

Ambiance Bain Sales : 01925 852675
sales@ambiancebain.com

FITTED FURNITURE

The fitted furniture range from Ambiance Bain is the most comprehensive on the market, featuring a wide collection of units and sizes allowing you to create unique bathrooms. Please take care to order the correct units for your client as all units are made to order and once confirmed no order may be changed, cancelled or amended in any way, under any circumstances.

All fitted units are priced including the necessary handles, plinth and worktop (without upstand). Units are priced in four groups, by door style, as listed below.

MODULAR FURNITURE

Pricing for our Modular, Komplements and Shower Spaces ranges can be found within their own relevant retail brochures.

MELAMINE DOOR STYLE



NATIVE
Price Group 0
Square edged

FOIL DOOR STYLE



KARLA
Price Group 1
Square edged



PROVENCE
Price Group 2
Country Shaker Style



PURA
Price Group 3
Integrated Chrome Handle

LAMINATE DOOR STYLE



LAGOON
Price Group 1
Square edged

Unit Dimensions shown are for the carcass size and do not include the fascia.

WC UNITS

ALL PRICES INCLUDE

- Handles
- Laminate worktop without upstand
- Plinth and legs (when requested)

WC UNIT including ■ GEBERIT cistern



* 40cm with ■ Macdee cistern.
❗ Not suitable for comfort height WC pans

Depth (cm)	Code	Width (cm)	Price Group 0	Price Group 1	Price Group 2	Price Group 3
33	WC3340*	40	£871	£908	£1017	£1192
	WC3350	50	£930	£991	£1111	£1269
	WC3360	60	£958	£1002	£1122	£1302
	WC3370	70	£1046	£1094	£1149	£1319
	WC3380	80	£1094	£1144	£1221	£1401
20	WC2040*	40	£871	£908	£1017	£1192
	WC2050	50	£930	£991	£1111	£1269
	WC2060	60	£958	£1002	£1122	£1302
	WC2070	70	£1046	£1094	£1149	£1319
	WC2080	80	£1094	£1144	£1221	£1401

FLOOR MOUNTED WC UNIT including ■ GEBERIT cistern

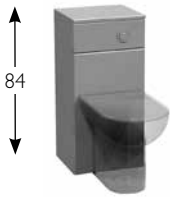

* 40cm with ■ Macdee cistern.
❗ Not suitable for comfort height WC pans

Depth (cm)	Code	Width (cm)	Price Group 0	Price Group 1	Price Group 2	Price Group 3
33	WCFL3340*	40	£871	£908	£1017	£1192
	WCFL3350	50	£930	£991	£1111	£1269
	WCFL3360	60	£958	£1002	£1122	£1302
	WCFL3370	70	£1046	£1094	£1149	£1319
	WCFL3380	80	£1094	£1144	£1221	£1401
20	WCFL2040*	40	£871	£908	£1017	£1192
	WCFL2050	50	£930	£991	£1111	£1269
	WCFL2060	60	£958	£1002	£1122	£1302
	WCFL2070	70	£1046	£1094	£1149	£1319
	WCFL2080	80	£1094	£1144	£1221	£1401

WALL HUNG WC UNIT including ■ GEBERIT fixing frame and cistern



Depth (cm)	Code	Width (cm)	Price Group 0	Price Group 1	Price Group 2	Price Group 3
33	WCWH3350	50	£1319	£1385	£1495	£1571
	WCWH3360	60	£1319	£1385	£1495	£1571
	WCWH3370	70	£1352	£1411	£1510	£1637
	WCWH3380	80	£1385	£1462	£1593	£1707
20	WCWH2050	50	£1319	£1385	£1495	£1571
	WCWH2060	60	£1319	£1385	£1495	£1571
	WCWH2070	70	£1352	£1411	£1510	£1637
	WCWH2080	80	£1385	£1462	£1593	£1707

COLOUR-MATCHED SIDE



To visible side of unit
£ 125 per side
£ 245 for tall unit

UPSTAND ON WORKTOP



FACREM
£28 per 10cm
N/A around a corner

CUT BACK IN DEPTH OF WORKTOP



DECPROF
Whole worktop will be square edged
£ 195

WORKTOP JOINT



JOINT
Factory prepared butt & scribe
£ 130

STRAIGHT FILLER

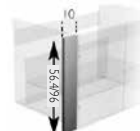

EFILLS6/96D
Includes extra laminate worktop and plinth
£ 119

PROVENCE END PANEL

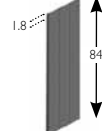

EPANELPROV20/33
Includes extra laminate worktop (20 deep shown)
£ 145

TALL WC UNITS

ALL PRICES INCLUDE

- Handles
- Laminate worktop without upstand
- Plinth and legs (when requested)

TALL WC UNIT including ■ GEBERIT cistern

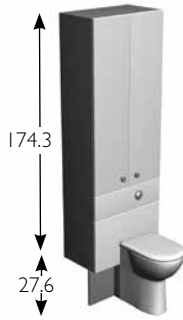

❗ Not suitable for comfort height WC pans

Depth (cm)	Code	Width (cm)	Price Group 0	Price Group 1	Price Group 2	Price Group 3
33	AWC3360	60	£1593	£1696	£1849	£2014
	AWC3370	70	£1620	£1736	£1889	£2036
	AWC3380	80	£1685	£1801	£1976	£2112
20	AWC2060	60	£1593	£1696	£1849	£2014
	AWC2070	70	£1620	£1736	£1889	£2036
	AWC2080	80	£1685	£1801	£1976	£2112

Add suffix **PU** to code for handleless push latch opening

FLOOR MOUNTED TALL WC UNIT including ■ GEBERIT cistern



❗ Not suitable for comfort height WC pans

Depth (cm)	Code	Width (cm)	Price Group 0	Price Group 1	Price Group 2	Price Group 3
33	AWCFL3360	60	£1593	£1696	£1849	£2014
	AWCFL3370	70	£1620	£1736	£1889	£2036
	AWCFL3380	80	£1685	£1801	£1976	£2112
20	AWCFL2060	60	£1593	£1696	£1849	£2014
	AWCFL2070	70	£1620	£1736	£1889	£2036
	AWCFL2080	80	£1685	£1801	£1976	£2112

Add suffix **PU** to code for handleless push latch opening

WALL HUNG TALL WC UNIT including ■ GEBERIT fixing frame and cistern



Depth (cm)	Code	Width (cm)	Price Group 0	Price Group 1	Price Group 2	Price Group 3
33	AWCWH3360	60	£1849	£1911	£2068	£2211
	AWCWH3370	70	£1871	£1937	£2090	£2239
	AWCWH3380	80	£1900	£1976	£2123	£2272
20	AWCWH2060	60	£1849	£1911	£2068	£2211
	AWCWH2070	70	£1871	£1937	£2090	£2239
	AWCWH2080	80	£1900	£1976	£2123	£2272

Add suffix **PU** to code for handleless push latch opening

PROVENCE TALL END PANEL

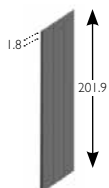

EPANELPROVA20/33
(20 deep shown) £ 285

CORNER FILLER



EFILLS6A
Includes extra laminate worktop and plinth
£ 224

STRAIGHT TALL FILLER



EFILL201D
Includes extra plinth
£ 119

CURVED END PANEL

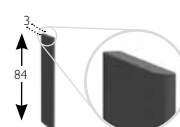

EPANELCUR20/33 £ 145
Includes extra laminate worktop with 14/19mm overhang and rounded end. Add ZDECCUR at £ 195 when used with SMO™ worktop

CURVED TALL END PANEL

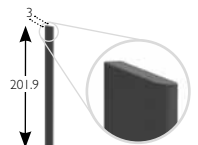

EPANELACUR20/33
£ 285

BIDET UNITS

ALL PRICES INCLUDE

- Handles
- Laminate worktop without upstand
- Plinth and legs (when requested)

BIDET UNIT

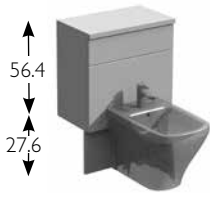

Depth (cm)	Code	Width (cm)	Price Group 0	Price Group 1	Price Group 2	Price Group 3
33	BBI3350	50	£656	£700	£831	£973
	BBI3360	60	£673	£722	£849	£1013
	BBI3370	70	£750	£816	£864	£1039
20	BBI2050	50	£656	£700	£831	£973
	BBI2060	60	£673	£722	£849	£1013
	BBI2070	70	£750	£816	£864	£1039

FLOOR MOUNTED BIDET UNIT

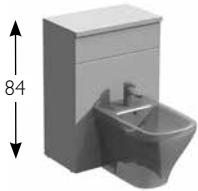

Also suitable for use with **■ GEBERIT** wall hung bidet frame (NOT INCLUDED)

Depth (cm)	Code	Width (cm)	Price Group 0	Price Group 1	Price Group 2	Price Group 3
33	BBIFL3350	50	£656	£700	£831	£973
	BBIFL3360	60	£673	£722	£849	£1013
	BBIFL3370	70	£750	£816	£864	£1039
20	BBIFL2050	50	£656	£700	£831	£973
	BBIFL2060	60	£673	£722	£849	£1013
	BBIFL2070	70	£750	£816	£864	£1039

TALL BIDET UNIT

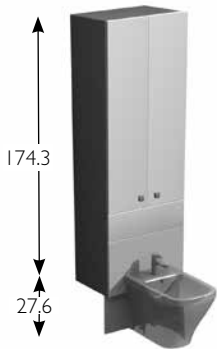

Depth (cm)	Code	Width (cm)	Price Group 0	Price Group 1	Price Group 2	Price Group 3
33	ABBI3360	60	£1309	£1415	£1565	£1729
	ABBI3370	70	£1335	£1455	£1605	£1749
	ABBI3380	80	£1399	£1519	£1689	£1829
20	ABBI2060	60	£1309	£1415	£1565	£1729
	ABBI2070	70	£1335	£1455	£1605	£1749
	ABBI2080	80	£1399	£1519	£1689	£1829

Add suffix **PU** to code for handleless push latch opening

FLOOR MOUNTED TALL BIDET UNIT



Depth (cm)	Code	Width (cm)	Price Group 0	Price Group 1	Price Group 2	Price Group 3
33	ABBIFL3360	60	£1309	£1415	£1565	£1729
	ABBIFL3370	70	£1335	£1455	£1605	£1749
	ABBIFL3380	80	£1399	£1519	£1689	£1829
20	ABBIFL2060	60	£1309	£1415	£1565	£1729
	ABBIFL2070	70	£1335	£1455	£1605	£1749
	ABBIFL2080	80	£1399	£1519	£1689	£1829

Add suffix **PU** to code for handleless push latch opening

BASIN UNITS

56.4 CM HIGH UNITS / 27.6 CM HIGH PLINTH

ALL PRICES INCLUDE

- Handles
- Laminate worktop without upstand
- Plinth and legs (when requested)

❗ We recommend the use of a super-slim self sealing trap with every basin unit

BASIN UNIT



Depth (cm)	Code	Width (cm)	Price Group 0	Price Group 1	Price Group 2	Price Group 3
33	BU3350	50	£706	£765	£820	£849
	BU3360	60	£706	£765	£820	£849
	BU3370	70	£772	£831	£838	£908
	BU3380	80	£831	£886	£897	£991

Add suffix **PU** to code for handleless push latch opening

REDUCED DEPTH BASIN UNIT

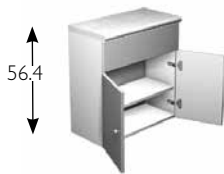

Depth (cm)	Code	Width (cm)	Price Group 0	Price Group 1	Price Group 2	Price Group 3
20	BU2050	50	£706	£765	£820	£849
	BU2060	60	£706	£765	£820	£849
	BU2070	70	£772	£831	£838	£908
	BU2080	80	£831	£886	£897	£991

❗ BU2050 not possible with SMO™ worktop

Add suffix **PU** to code for handleless push latch opening

SLIM BASIN UNIT

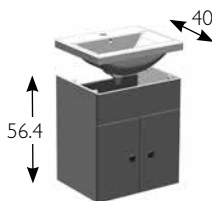

	Depth (cm)	Code	Width (cm)	Price Group 0	Price Group 1	Price Group 2	Price Group 3
BASIN	40	VAMBSL50	51	£175	£175	£175	£175
	40	VAMBSL60	61	£185	£185	£185	£185
UNIT	37	BU3750	50	£612	£662	£711	£733
	37	BU3760	60	£612	£662	£711	£733

❗ Only for use with Ceramic Slim Basin

Add suffix **PU** to code for handleless push latch opening

BASIN DRAWER UNIT

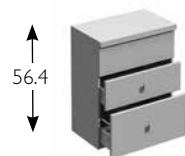

Depth (cm)	Code	Width (cm)	Price Group 0	Price Group 1	Price Group 2	Price Group 3
33	BUT3360	60	£908	£973	£991	£1090
	BUT3370	70	£973	£1050	£1061	£1171
	BUT3380	80	£1039	£1122	£1160	£1221

❗ No moulding on Provence drawer fascias

Add suffix **PU** to code for handleless push latch opening

SUPER-SLIM TRAP



Code	Price
SSTRAP	£43

Individually ordered wastes, handles and ancillary items will incur a £10 P & P charge.

BASIN UNITS

56.4 CM HIGH UNITS / 27.6 CM HIGH PLINTH

ALL PRICES INCLUDE

- Handles
- Laminate worktop without upstand
- Plinth and legs (when requested)

❗ We recommend the use of a super-slim self sealing trap with every basin unit

60 OFFSET BASIN UNIT (RH shown)

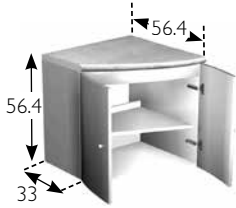

	Depth (cm)	Code	Width (cm)	Price Group 0	Price Group 1	Price Group 2	Price Group 3
RH	33/56	DBA60R	60	N/A	£1696	£1779	N/A
LH	56/33	DBA60L	60	N/A	£1696	£1779	N/A

Add suffix **PU** to code for handleless push latch opening

❗ Always square edged worktop. Laminate doors will have laminate horizontal edges with hand finished visible joint line. N/A with all handles due to shaped fronts. When using laminate or solid surface worktops check the size of the ceramic basin that you are using. Hinges and soft close mechanisms will operate differently on curved doors due to opposing closing angles

REDUCED DEPTH 60 OFFSET BASIN UNIT (LH shown)

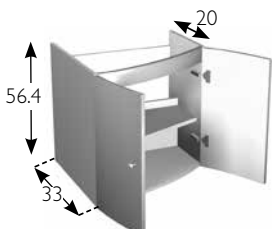

	Depth (cm)	Code	Width (cm)	Price Group 0	Price Group 1	Price Group 2	Price Group 3
RH	20/33	DBA2060R	60	N/A	£1182	£1243	N/A
LH	33/20	DBA2060L	60	N/A	£1182	£1243	N/A

Add suffix **PU** to code for handleless push latch opening

❗ N/A with laminate or solid surface worktops. Laminate doors will have laminate horizontal edges with hand finished visible joint line. N/A with all handles due to shaped fronts. Hinges and soft close mechanisms will operate differently on curved doors due to opposing closing angles

90 OFFSET BASIN UNIT (RH shown)



	Depth (cm)	Code	Width (cm)	Price Group 0	Price Group 1	Price Group 2	Price Group 3
RH	33/56	ISEO90R	90	N/A	£1911	£2003	N/A
LH	56/33	ISEO90L	90	N/A	£1911	£2003	N/A

Add suffix **PU** to code for handleless push latch opening

❗ Always square-edged worktop. Laminate doors will have laminate horizontal edges with hand finished visible joint line. N/A with all handles due to shaped fronts. When using laminate or solid surface worktops check the size of the ceramic basin that you are using. Hinges and soft close mechanisms will operate differently on curved doors due to opposing closing angles

SUPER-SLIM TRAP



Code	Price
SSTRAP	£43

Individually ordered wastes, handles and ancillary items will incur a £10 P & P charge.

COLOUR-MATCHED SIDE



To visible side of unit
£125 per side
£245 for tall unit

UPSTAND ON WORKTOP



FACREM
£28 per 10cm
N/A around a corner

CUT BACK IN DEPTH OF WORKTOP

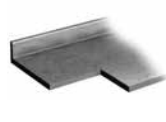

DECPROF
Whole worktop will be square edged
£195

WORKTOP JOINT



JOINT
Factory prepared butt & scribe for laminate worktops
£130

STRAIGHT FILLER

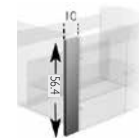

EFILL56D
Includes extra laminate worktop and plinth
£119

BASIN UNITS

56.4 CM HIGH UNITS / 27.6 CM HIGH PLINTH

ALL PRICES INCLUDE

- Handles
- Laminate worktop without upstand
- Plinth and legs (when requested)

1 We recommend the use of a super-slim self sealing trap with every basin unit

REDUCED DEPTH 90 OFFSET BASIN UNIT (LH shown)

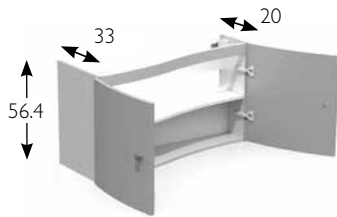

	Depth (cm)	Code	Width (cm)	Price Group 0	Price Group 1	Price Group 2	Price Group 3
RH	20/33	ISEO2090R	90	N/A	£1696	£1779	N/A
LH	33/20	ISEO2090L	90	N/A	£1696	£1779	N/A

Add suffix **PU** to code for handleless push latch opening

1 N/A with laminate or solid surface top. Laminate doors will have laminate horizontal edges with hand finished visible joint line. N/A with all handles due to shaped fronts Hinges and soft close mechanisms will operate differently on curved doors due to opposing closing angles

ROUNDED FRONT BASIN UNIT

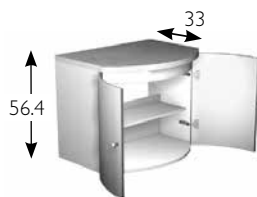

	Depth (cm)	Code	Width (cm)	Price Group 0	Price Group 1	Price Group 2	Price Group 3
	33/51	BA70	70	N/A	£1762	£1849	N/A

Add suffix **PU** to code for handleless push latch opening

1 Always square-edged worktop. Laminate doors will have laminate horizontal edges with hand finished visible joint line. N/A with all handles due to shaped fronts. When using laminate or solid surface worktops check the size of the ceramic basin that you are using.

REDUCED DEPTH ROUNDED FRONT BASIN UNIT

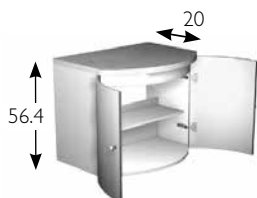

	Depth (cm)	Code	Width (cm)	Price Group 0	Price Group 1	Price Group 2	Price Group 3
	20/40	BA2055	55	N/A	£1144	£1203	N/A
	20/41	BA2070	70	N/A	£1225	£1287	N/A

Add suffix **PU** to code for handleless push latch opening

1 Not available with Laminate

1 Laminate doors will have laminate horizontal edges with hand finished visible joint line. Not available with all handles due to shaped front. Only available with SMO™ top and basin.

SUPER-SLIM TRAP



Code	Price
SSTRAP	£43

Individually ordered wastes, handles and ancillary items will incur a £10 P & P charge.

STRAIGHT FILLER

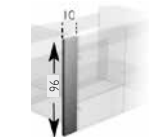

EFILL96D
Includes extra laminate worktop and plinth
£119

CORNER FILLER



EFILL56A
Includes extra laminate worktop and plinth
£224

CURVED END PANEL

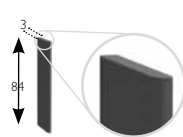

EPANELCUR20/33 £145
Includes extra laminate worktop with 14/19mm overhang and rounded end. Add ZDECCUR at £195 when used with SMO™ or solid surface worktops

PROVENCE END PANEL

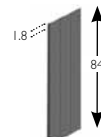

EPANELPROV20/33/60
Includes extra laminate worktop (20 deep shown)
£145



SMO™ WORKTOPS
see page 24-27

BATH PANELS
see page 29

MIRRORS
see page 30-31

ANCILLARY ITEMS
see page 36-37

BASE UNITS

56.4 CM HIGH UNITS / 27.6 CM HIGH PLINTH

ALL PRICES INCLUDE

- Handles
- Laminate worktop without upstand
- Plinth and legs (when requested)

I DOOR LEFT HAND



* N/A in PURA door style.

Add suffix **PU** to code for handleless push latch opening

Depth (cm)	Code	Width (cm)	Price Group 0	Price Group 1	Price Group 2	Price Group 3
33	B3320L*	20	£487	£525	£564	
	B3325L*	25	£487	£525	£564	
	B3330L	30	£487	£525	£564	£656
	B3335L	35	£525	£564	£608	£695
	B3340L	40	£564	£590	£641	£733
20	B2020L*	20	£487	£525	£564	
	B2025L*	25	£487	£525	£564	
	B2030L	30	£487	£525	£564	£656
	B2035L	35	£525	£564	£608	£695
	B2040L	40	£564	£590	£641	£733

I DOOR RIGHT HAND



* N/A in PURA door style.

Add suffix **PU** to code for handleless push latch opening

Depth (cm)	Code	Width (cm)	Price Group 0	Price Group 1	Price Group 2	Price Group 3
33	B3320R*	20	£487	£525	£564	
	B3325R*	25	£487	£525	£564	
	B3330R	30	£487	£525	£564	£656
	B3335R	35	£525	£564	£608	£695
	B3340R	40	£564	£590	£641	£733
20	B2020R*	20	£487	£525	£564	
	B2025R*	25	£487	£525	£564	
	B2030R	30	£487	£525	£564	£656
	B2035R	35	£525	£564	£608	£695
	B2040R	40	£564	£590	£641	£733

BASE UNIT 2 DOORS



* N/A in PURA door style.

Add suffix **PU** to code for handleless push latch opening

Depth (cm)	Code	Width (cm)	Price Group 0	Price Group 1	Price Group 2	Price Group 3
33	B3340*	40	£772	£860	£897	
	B3360	60	£772	£860	£897	£925
	B3370	70	£860	£925	£973	£1024
	B3380	80	£925	£1013	£1057	£1090
20	B2040*	40	£772	£860	£897	
	B2060	60	£772	£860	£897	£925
	B2070	70	£860	£925	£973	£1024
	B2080	80	£925	£1013	£1057	£1090

SLIDING DRAWER

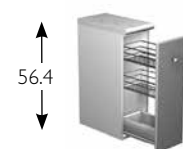

Depth (cm)	Code	Width (cm)	Price Group 0	Price Group 1	Price Group 2	Price Group 3
33	BC3320*	20	£684	£733	£798	

Not available with push latch opening

ⓘ Supplied with 2 inside metal basket trays

* N/A in PURA door style.

COLOUR-MATCHED SIDE



To visible side of unit
£ 125 per side
£ 245 for tall unit

UPSTAND ON WORKTOP



FACREM
£ 28 per 10cm
N/A around a corner

CUT BACK IN DEPTH OF WORKTOP



DECPROF
Whole worktop will be square edged
£ 195

WORKTOP JOINT



JOINT
Factory prepared butt & scribe for laminate worktop
£ 130

STRAIGHT FILLER



EFILL56/96D
Includes extra laminate worktop and plinth
£ 119

BASE UNITS

56.4 CM HIGH UNITS / 27.6 CM HIGH PLINTH

ALL PRICES INCLUDE

- Handles
- Laminate worktop without upstand
- Plinth and legs (when requested)

1 DOOR, 1 DRAWER (RH shown)



	Depth (cm)	Code	Width (cm)	Price Group 0	Price Group 1	Price Group 2	Price Group 3
LH	33	BPT3330L	30	£772	£849	£886	£908
		BPT3335L	35	£831	£886	£947	£958
		BPT3340L	40	£871	£925	£991	£1013
RH	33	BPT3330R	30	£772	£849	£886	£908
		BPT3335R	35	£831	£886	£947	£958
		BPT3340R	40	£871	£925	£991	£1013

❶ No moulding on Provence drawer fascias

Add suffix **PU** to code for handleless push latch opening

3 DRAWERS



	Depth (cm)	Code	Width (cm)	Price Group 0	Price Group 1	Price Group 2	Price Group 3
33	33	BT3315*	15	£816	£860	£947	£1061
		BT3330	30	£816	£860	£947	£1061
		BT3335	35	£886	£925	£1024	£1144
		BT3340	40	£908	£958	£1061	£1182

* 15cm unit N/A with all handles due to size and screw fixings, not possible push latch

❶ No moulding on Provence drawer fascias

Add suffix **PU** to code for handleless push latch opening

TOILET ROLL UNIT



CARCASE COLOURS
COLOURMATCHED INSIDE

	Depth (cm)	Code	Width (cm)	Price Group 0	Price Group 1	Price Group 2	Price Group 3
33	33	BTR3315	15	£535	£564	£590	£684
		BTR2015	15	£535	£564	£590	£684
33	33	BTR3315C	15	£535	£733	£787	£860
		BTR2015C	15	£535	£733	£787	£860

❶ No handle with unit.

❶ Lift up door: ❶ Internal colourmatching in laminate colours only. ❶ Not available with push latch opening. ❶ No moulding on Provence Door Style

TOILET ROLL DOOR UNIT

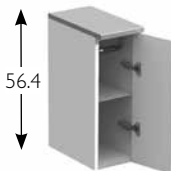

LH
RH

	Depth (cm)	Code	Width (cm)	Price Group 0	Price Group 1	Price Group 2	Price Group 3
LH	33	BTR3320L	20	£546	£575	£601	N/A
		BTR2020L	20	£546	£575	£601	N/A
RH	33	BTR3320R	20	£546	£575	£601	N/A
		BTR2020R	20	£546	£575	£601	N/A

* N/A in PURA DOORSTYLE

Add suffix **PU** to code for handleless push latch opening

CORNER FILLER



EFILLS6A
Includes extra laminate worktop and plinth
£ 224

CURVED END PANEL

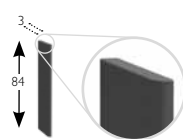

EPANELCUR20/33 £ 145
Includes extra laminate worktop with 14/19mm overhang and rounded end.
Add ZDECCUR at £ 195 when used with SMO™ or solid surface worktops

PROVENCE END PANEL

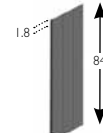

EPANELPROV20/33/60
Includes extra laminate worktop (20 deep shown)
£ 145



SMO™ WORKTOPS
see page 24-27

BATH PANELS
see page 29

MIRRORS
see page 30-31

ANCILLARY ITEMS
see page 36-37

BASE UNITS

56.4 CM HIGH UNITS / 27.6 CM HIGH PLINTH

ALL PRICES INCLUDE

- Handles
- Laminate worktop without upstand
- Plinth and legs (when requested)

STRAIGHT CORNER UNIT (RH shown)



LH

RH

Depth (cm)	Code	Width (cm)	Price Group 0	Price Group 1	Price Group 2	Price Group 3
33	BAB3350L	50	£820	£886	£908	£947
33	BAB3355L	55	£886	£947	£973	£1024
33	BAB3360L	60	£958	£1039	£1061	£1090
20	BAB2050L	50	£820	£886	£908	£947
20	BAB2055L	55	£886	£947	£973	£1024
20	BAB2060L	60	£958	£1039	£1061	£1090
33	BAB3350R	50	£820	£886	£908	£947
33	BAB3355R	55	£886	£947	£973	£1024
33	BAB3360R	60	£958	£1039	£1061	£1090
20	BAB2050R	50	£820	£886	£908	£947
20	BAB2055R	55	£886	£947	£973	£1024
20	BAB2060R	60	£958	£1039	£1061	£1090

❗ Supplied with loose base 10cm filler.
See page 38 for spacing requirement

Add suffix **PU** to code for handleless push latch opening

OPEN SHELF UNIT



Depth (cm)	Width (cm)	Carcase colours		Colourmatch inside (laminite colours only)	
		Code	Price	Code	Price
33	15	BN3315	£400	BN3315C	£590
	30	BN3330	£411	BN3330C	£590
	35	BN3335	£433	BN3335C	£590
	40	BN3340	£437	BN3340C	£656
20	15	BN2015	£400	BN2015C	£590
	30	BN2030	£411	BN2030C	£590
	35	BN2035	£433	BN2035C	£590
	40	BN2040	£437	BN2040C	£656

❗ All open shelf units are supplied unassembled to allow for cutting down on site when necessary

COLOUR-MATCHED SIDE



To visible side of unit
£ 125 per side
£ 245 for tall unit

UPSTAND ON WORKTOP



FACREM
£ 28 per 10cm
N/A around a corner

CUT BACK IN DEPTH OF WORKTOP

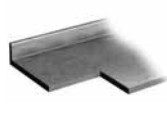

DECPROF
Whole worktop will be square edged
£ 195

WORKTOP JOINT



JOINT
Factory prepared butt & scribe for laminate worktops
£ 130

STRAIGHT FILLER

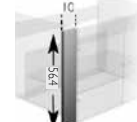

EFILL56D
Includes extra laminate worktop and plinth
£ 119

CUT BACK BASE UNITS

56.4 CM HIGH UNITS / 27.6 CM HIGH PLINTH

ALL PRICES INCLUDE

- Handles
- Laminate worktop without upstand
- Plinth and legs (when requested)

I DOOR ANGLED CUT BACK UNIT (LH shown)

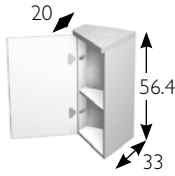

	Depth (cm)	Code	Width (cm)	Price Group 0	Price Group 1	Price Group 2	Price Group 3
LH	20/33	BPC3330L	30	£722	£772	£798	£827
RH	33/20	BPC3330R	30	£722	£772	£798	£827

Add suffix **PU** to code for handleless push latch opening

- ❗ Restricted soft close action due to shape
- ❗ Add ZDECPS at £195 when used with SMO™ or Solid Surface worktops.

I DOOR ROUNDED CUT BACK UNIT (LH shown)

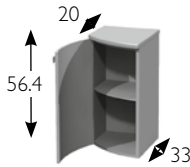

	Depth (cm)	Code	Width (cm)	Price Group 0	Price Group 1	Price Group 2	Price Group 3
LH	20/33	BRC3330L	30	N/A	£871	£914	N/A
RH	33/20	BRC3330R	30	N/A	£871	£914	N/A

Add suffix **PU** to code for handleless push latch opening

- ❗ N/A with all handles due to shaped front.
- ❗ Add ZDECRC at £195 when used with SMO™ or Solid Surface worktops.
- ❗ Hinges and soft close mechanisms will operate differently on curved doors due to closing angles

I DOOR ROUNDED END UNIT (RH shown)

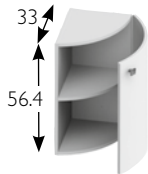

	Depth (cm)	Code	Width (cm)	Price Group 0	Price Group 1	Price Group 2	Price Group 3
LH	0/33	BA3330L	30	N/A	£952	£995	N/A
RH	33/0	BA3330R	30	N/A	£952	£995	N/A
LH	0/20	BA2030L	30	N/A	£952	£995	N/A
RH	20/0	BA2030R	30	N/A	£952	£995	N/A

Add suffix **PU** to code for handleless push latch opening

- ❗ Add ZDECBAT at £195 when used with SMO™ or Solid Surface worktops.
- ❗ N/A with all handles due to shaped front.
- ❗ Please allow 14 to 25mm for worktop overhang.
- ❗ Hinges and soft close mechanisms will operate differently on curved doors due to closing angles
- ❗ Includes rounded end plinth.

PROVENCE END PANEL

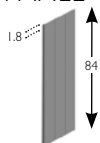

EPANELPROV20/33
Includes extra laminate worktop (20 deep shown)
£ 145

STRAIGHT FILLER

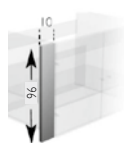

EFILL96D
Includes extra laminate worktop and plinth
£ 119

CORNER FILLER



EFILL56A
Includes extra laminate worktop and plinth
£ 224



SMO™ WORKTOPS
see page 24-27

BATH PANELS
see page 29

MIRRORS
see page 30-31

ANCILLARY ITEMS
see page 36-37

HI-LINE WC UNITS

69.2 CM HIGH UNITS / 14.8 CM HIGH PLINTH

ALL PRICES INCLUDE

- Handles
- Laminate worktop without upstand
- Plinth and legs (when requested)

HI-LINE WC UNIT including ■ GEBERIT cistern

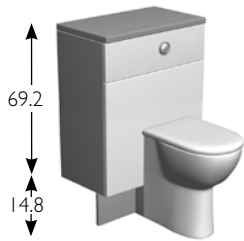

* 40cm with ■ Macdee cistern and central button
❗ Not suitable for comfort height WC pans

Depth (cm)	Code	Width (cm)	Price Group 0	Price Group 1	Price Group 2	Price Group 3
33	WCHL3340*	40	£871	£908	£1017	£1192
	WCHL3350	50	£930	£991	£1111	£1269
	WCHL3360	60	£958	£1002	£1122	£1302
	WCHL3370	70	£1046	£1094	£1149	£1319
	WCHL3380	80	£1094	£1144	£1221	£1401
20	WCHL2040*	40	£871	£908	£1017	£1192
	WCHL2050	50	£930	£991	£1111	£1269
	WCHL2060	60	£958	£1002	£1122	£1302
	WCHL2070	70	£1046	£1094	£1149	£1319
	WCHL2080	80	£1094	£1144	£1221	£1401

FOR WALL HUNG AND FLOOR MOUNTED WC UNITS SEE PAGE 2

HI-LINE TOILET ROLL UNIT

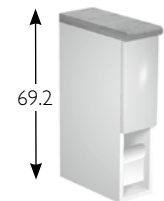

Carcase colours
Colourmatched inside

Depth (cm)	Code	Width (cm)	Price Group 0	Price Group 1	Price Group 2	Price Group 3
33	BTRHL3315	15	£535	£564	£590	£684
20	BTRHL2015	15	£535	£564	£590	£684
33	BTRHL3315C	15	£535	£733	£787	£860
20	BTRHL2015C	15	£535	£733	£787	£860

- ❗ Not available with Push Latch Opening
- ❗ No handle on unit
- ❗ No moulding on Provence door style
- ❗ Lift up door
- ❗ Internal colour matching in laminate colours only

HI-LINE TOILET ROLL DOOR UNIT

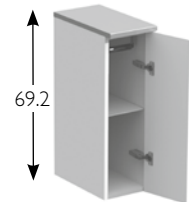

LH
RH

Depth (cm)	Code	Width (cm)	Price Group 0	Price Group 1	Price Group 2	Price Group 3
33	BTRHL3320L	20	£546	£575	£601	N/A
20	BTRHL2020L	20	£546	£575	£601	N/A
33	BTRHL3320R	20	£546	£575	£601	N/A
20	BTRHL2020R	20	£546	£575	£601	N/A

* N/A in PURA door style. Add suffix **PU** to code for handleless push latch opening

HI-LINE BIDET UNIT

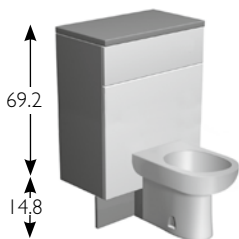

Depth (cm)	Code	Width (cm)	Price Group 0	Price Group 1	Price Group 2	Price Group 3
33	BBIHL3350	50	£656	£700	£831	£973
	BBIHL3360	60	£673	£722	£849	£1013
	BBIHL3370	70	£750	£816	£864	£1039
20	BBIHL2050	50	£656	£700	£831	£973
	BBIHL2060	60	£673	£722	£849	£1013
	BBIHL2070	70	£750	£816	£864	£1039

FOR WALL HUNG AND FLOOR MOUNTED BIDET UNITS SEE PAGE 4

COLOURMATCHED SIDE



To visible side of unit
£ 125 per side
£ 245 for tall unit

UPSTAND ON WORKTOP

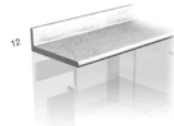

FACREM
£ 28 per 10cm
N/A around a corner

CUT BACK IN DEPTH OF WORKTOP

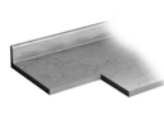

DECPROF
Whole worktop will be square edged
£ 195

WORKTOP JOINT



JOINT
Factory prepared butt & scribe for laminate worktops.
£ 130

HI-LINE BASIN UNITS

69.2 CM HIGH UNITS / 14.8 CM HIGH PLINTH

ALL PRICES INCLUDE

- Handles
- Laminate worktop
- Plinth and legs (when requested)

❗ We recommend the use of a super-slim self sealing trap with every basin unit

HI-LINE BASIN UNIT

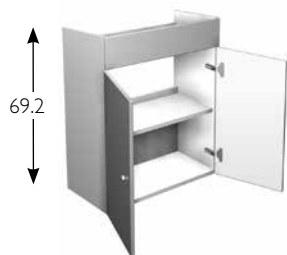

Depth (cm)	Code	Width (cm)	Price Group 0	Price Group 1	Price Group 2	Price Group 3
33	BUHL3350	50	£706	£765	£820	£849
	BUHL3360	60	£706	£765	£820	£849
	BUHL3370	70	£772	£831	£838	£908
	BUHL3380	80	£831	£886	£897	£991
20	BUHL2050	50	£706	£765	£820	£849
	BUHL2060	60	£706	£765	£820	£849
	BUHL2070	70	£772	£831	£838	£908
	BUHL2080	80	£831	£886	£897	£991

❗ BUHL2050 Not possible with SMO™ Worktop Add suffix **PU** to code for handleless push latch opening

HI-LINE BASIN DRAWER UNIT



Depth (cm)	Code	Width (cm)	Price Group 0	Price Group 1	Price Group 2	Price Group 3
33	BUTHL3360	60	£908	£973	£991	£1090
	BUTHL3370	70	£973	£1050	£1061	£1171
	BUTHL3380	80	£1039	£1122	£1160	£1221

Add suffix **PU** to code for handleless push latch opening

❗ No moulding on Provence drawer fascias

SLIM BASIN UNIT

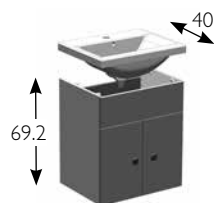

	Depth (cm)	Code	Width (cm)	Price Group 0	Price Group 1	Price Group 2	Price Group 3
BASIN	40	VAMBSL50	51	£175	£175	£175	£175
	40	VAMBSL60	61	£185	£185	£185	£185
UNIT	37	BUHL3750	50	£612	£662	£711	£733
	37	BUHL3760	60	£612	£662	£711	£733

Add suffix **PU** to code for handleless push latch opening

❗ Only for use with Ceramic Slim Basin

SUPER-SLIM TRAP



Code	Price
SSTRAP	£43

Individually ordered wastes, handles and ancillary items will incur a £10 P & P charge.

HI-LINE CORNER FILLER



EFILL69A
Includes extra laminate worktop and plinth
£ 225

STRAIGHT FILLER

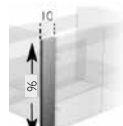

EFILL96D
Includes extra laminate worktop and plinth
£ 119

PROVENCE END PANEL

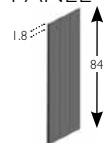

EPANELPROV20/33/60
Includes extra laminate worktop (20 deep shown)
£ 145



SMO™ WORKTOPS
see page 24-27

BATH PANELS
see page 29

MIRRORS
see page 30-31

ANCILLARY ITEMS
see page 36-37

HI-LINE UNITS

69.2 CM HIGH UNITS / 14.8 CM HIGH PLINTH

ALL PRICES INCLUDE

- Handles
- Laminate worktop
- Plinth and legs (when requested)

HI-LINE BASE UNIT 2 DOORS

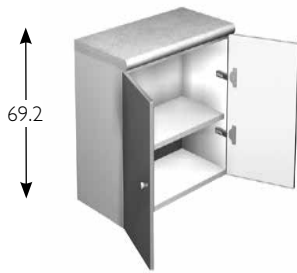

* N/A in PURA door style.

Depth (cm)	Code	Width (cm)	Price Group 0	Price Group 1	Price Group 2	Price Group 3
33	BHL3340*	40	£772	£860	£897	
	BHL3360	60	£772	£860	£897	£925
	BHL3370	70	£860	£925	£973	£1024
	BHL3380	80	£925	£1013	£1057	£1090
20	BHL2040*	40	£772	£860	£897	
	BHL2060	60	£772	£860	£897	£925
	BHL2070	70	£860	£925	£973	£1024
	BHL2080	80	£925	£1013	£1057	£1090

Add suffix **PU** to code for handleless push latch opening

HI-LINE 1 DOOR LEFT HAND



* N/A in PURA door style.

Depth (cm)	Code	Width (cm)	Price Group 0	Price Group 1	Price Group 2	Price Group 3
33	BHL3320L*	20	£487	£525	£564	
	BHL3325L*	25	£487	£525	£564	
	BHL3330L	30	£487	£525	£564	£656
	BHL3335L	35	£525	£564	£608	£695
	BHL3340L	40	£564	£590	£641	£733
20	BHL2020L*	20	£487	£525	£564	
	BHL2025L*	25	£487	£525	£564	
	BHL2030L	30	£487	£525	£564	£656
	BHL2035L	35	£525	£564	£608	£695
	BHL2040L	40	£564	£590	£641	£733

Add suffix **PU** to code for handleless push latch opening

HI-LINE 1 DOOR RIGHT HAND

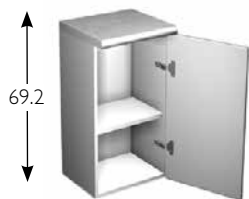

* N/A in PURA door style.

Depth (cm)	Code	Width (cm)	Price Group 0	Price Group 1	Price Group 2	Price Group 3
33	BHL3320R*	20	£487	£525	£564	
	BHL3325R*	25	£487	£525	£564	
	BHL3330R	30	£487	£525	£564	£656
	BHL3335R	35	£525	£564	£608	£695
	BHL3340R	40	£564	£590	£641	£733
20	BHL2020R*	20	£487	£525	£564	
	BHL2025R*	25	£487	£525	£564	
	BHL2030R	30	£487	£525	£564	£656
	BHL2035R	35	£525	£564	£608	£695
	BHL2040R	40	£564	£590	£641	£733

Add suffix **PU** to code for handleless push latch opening

COLOURMATCHED SIDE



To visible side of unit
£ 125 per side
£ 245 for tall unit

UPSTAND ON WORKTOP



FACREM
£ 28 per 10cm
N/A around a corner

CUT BACK IN DEPTH OF WORKTOP

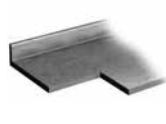

DECPROF
Whole worktop will be square edged
£ 195

WORKTOP JOINT



JOINT
Factory prepared butt & scribe for laminate worktops
£ 130

STRAIGHT FILLER



EFILL96D
Includes extra laminate worktop and plinth
£ 119

HI-LINE UNITS

69.2 CM HIGH UNITS / 14.8 CM HIGH PLINTH

ALL PRICES INCLUDE

- Handles
- Laminate worktop
- Plinth and legs (when requested)

HI-LINE 1 DOOR, 1 DRAWER (RH shown)



LH

RH

Depth (cm)	Code	Width (cm)	Price Group 0	Price Group 1	Price Group 2	Price Group 3
33	BPTHL3330L	30	£772	£849	£886	£908
	BPTHL3335L	35	£831	£886	£947	£958
	BPTHL3340L	40	£871	£925	£991	£1013
33	BPTHL3330R	30	£772	£849	£886	£908
	BPTHL3335R	35	£831	£886	£947	£958
	BPTHL3340R	40	£871	£925	£991	£1013

Add suffix **PU** to code for handleless push latch opening

❗ No moulding on Provence drawer fascia

HI-LINE 4 DRAWER UNIT

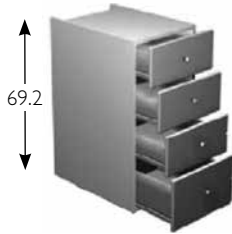

Depth (cm)	Code	Width (cm)	Price Group 0	Price Group 1	Price Group 2	Price Group 3
33	BTHL3330	30	£816	£860	£947	£1061
	BTHL3335	35	£886	£925	£1024	£1144
	BTHL3340	40	£908	£958	£1061	£1182

Add suffix **PU** to code for handleless push latch opening

❗ No moulding on Provence drawer fascias

HI-LINE 1 DOOR ANGLED CUT BACK UNIT (LH shown)

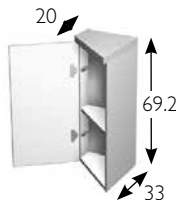

LH

RH

Depth (cm)	Code	Width (cm)	Price Group 0	Price Group 1	Price Group 2	Price Group 3
20/33	BPCHL3330L	30	£722	£772	£798	£827
33/20	BPCHL3330R	30	£722	£772	£798	£827

Add suffix **PU** to code for handleless push latch opening

❗ Restricted soft close action due to shape

❗ Add ZDECPS at £195 when used with SMO™ or Solid Surface worktops.

HI-LINE CORNER FILLER



EFILL69A
Includes extra laminate worktop and plinth
£ 225

CURVED END PANEL

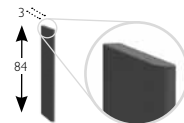

EPANELCUR20/33 £ 145
Includes extra laminate worktop with 14/19mm overhang and rounded end.
Add ZDECCUR at £ 195 when used with SMO™ worktop

PROVENCE END PANEL

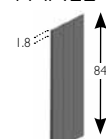

EPANELPROV20/33/60
Includes extra laminate worktop (20 deep shown)
£ 145



SMO™ WORKTOPS
see page 24-27

BATH PANELS
see page 29

MIRRORS
see page 30-31

ANCILLARY ITEMS
see page 36-37

50CM DEEP UNITS

56.4 CM HIGH UNITS

ALL PRICES INCLUDE

- Handles
- Laminate worktop without upstand
- Plinth and legs (when requested)

BASIN UNIT WITH 2 FULL HEIGHT DOORS



Depth (cm)	Code	Width (cm)	Price Group 0	Price Group 1	Price Group 2	Price Group 3
47.5	BV564760	60	£991	£1079	£1105	£1133
	BV564770	70	£1079	£1144	£1182	£1210
	BV564780	80	£1133	£1221	£1247	£1276
	BV564790	90	£1210	£1302	£1330	£1357

Add suffix **PU** to code for handleless push latch opening

❗ For inset countertop basin

BASIN UNIT WITH 2 DRAWERS



Depth (cm)	Code	Width (cm)	Price Group 0	Price Group 1	Price Group 2	Price Group 3
47.5	BVC564760	60	£1094	£1160	£1210	£1236
	BVC564770	70	£1171	£1247	£1302	£1319
	BVC564780	80	£1243	£1330	£1379	£1396
	BVC564790	90	£1313	£1411	£1462	£1473

Add suffix **PU** to code for handleless push latch opening

❗ For Sit-on bowl or SMO™ top with square or Dolce bowl. Super slim self sealing waste/trap SSTRAP always required. Not suitable for SMO™ oval or Inset ceramic bowl due to top drawer. ❗ Provence drawer fascias with moulding

1 DOOR UNIT (RH shown)



	Depth (cm)	Code	Width (cm)	Price Group 0	Price Group 1	Price Group 2	Price Group 3
LH	47.5	B564730L	30	£700	£750	£761	£798
		B564735L	35	£733	£787	£816	£831
		B564740L	40	£772	£831	£860	£871
RH	47.5	B564730R	30	£700	£750	£761	£798
		B564735R	35	£733	£787	£816	£831
		B564740R	40	£772	£831	£860	£871

Add suffix **PU** to code for handleless push latch opening

2 DRAWER UNIT

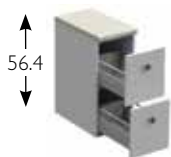

Depth (cm)	Code	Width (cm)	Price Group 0	Price Group 1	Price Group 2	Price Group 3
47.5	BT564730	30	£936	£984	£1083	£1225
	BT564735	35	£1017	£1061	£1177	£1313
	BT564740	40	£1046	£1100	£1225	£1346

Add suffix **PU** to code for handleless push latch opening

A LARGER SELECTION OF 50CM & 60CM DEEP BASE AND 60CM DEEP TALL UNITS ARE AVAILABLE FROM OUR FRENCH RANGE.

CONTACT OUR SALES OFFICE FOR MORE INFORMATION:
01925 852675

CUT BACK IN DEPTH OF WORKTOP

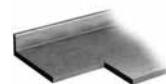

DECPROF
Whole worktop will be square edged
£195

STRAIGHT FILLER



EFILL56D
Includes extra laminate worktop and plinth
£119

60CM DEEP UNITS

56.4 CM HIGH UNITS / 27.6 CM HIGH PLINTH

ALL PRICES INCLUDE

- Handles
- Laminate worktop without upstand
- Plinth and legs (when requested)

BASIN UNIT WITH 2 FULL HEIGHT DOORS



Depth (cm)	Code	Width (cm)	Price Group 0	Price Group 1	Price Group 2	Price Group 3
56.4	BFD5660	60	£991	£1079	£1105	£1133
	BFD5670	70	£1079	£1144	£1182	£1210
	BFD5680	80	£1133	£1221	£1247	£1276
	BFD5690	90	£1210	£1302	£1330	£1357
	BFD56100	100	£1258	£1374	£1401	£1422

❗ For inset countertop basin, laminate or SMO™ top

Add suffix **PU** to code for handleless push latch opening

BASIN UNIT WITH 2 DRAWERS



Depth (cm)	Code	Width (cm)	Price Group 0	Price Group 1	Price Group 2	Price Group 3
56.4	BVC565660	60	£1094	£1160	£1210	£1236
	BVC565670	70	£1171	£1247	£1302	£1319
	BVC565690	90	£1313	£1411	£1462	£1473

Add suffix **PU** to code for handleless push latch opening

❗ For Sit-on bowl or SMO™ top. Super slim self sealing waste/trap SSTRAP always required.

Not suitable for SMO™ oval or Inset ceramic bowl due to top drawer: Use SMO™ Dolce or square style.

❗ Provence drawer fascias with moulding

1 DOOR UNIT (RH shown)



	Depth (cm)	Code	Width (cm)	Price Group 0	Price Group 1	Price Group 2	Price Group 3
LH	56.4	B5630L	30	£700	£750	£761	£798
		B5635L	35	£733	£787	£816	£831
		B5640L	40	£772	£831	£860	£871
RH	56.4	B5630R	30	£700	£750	£761	£798
		B5635R	35	£733	£787	£816	£831
		B5640R	40	£772	£831	£860	£871

Add suffix **PU** to code for handleless push latch opening

3 DRAWERS UNIT

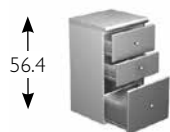

Depth (cm)	Code	Width (cm)	Price Group 0	Price Group 1	Price Group 2	Price Group 3
56.4	BT5630	30	£897	£947	£1039	£1171
	BT5635	35	£973	£1017	£1127	£1258
	BT5640	40	£1002	£1057	£1171	£1298

Add suffix **PU** to code for handleless push latch opening

❗ No moulding on Provence drawer fascias

UPSTAND ON WORKTOP



FACREM
£ 28 per 10cm
N/A around a corner

WORKTOP JOINT



JOINT
Factory prepared butt
& scribe for laminate worktops
£ 130

CORNER FILLER



EFILL56A
Includes extra laminate
worktop and plinth
£ 224

PROVENCE END PANEL

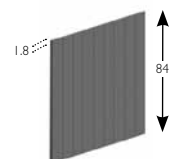

EPANELPROV60
Includes extra laminate worktop
£ 145

TALL UNITS

174.3 CM HIGH UNITS / 27.6 CM HIGH PLINTH

ALL PRICES INCLUDE

- Handles
- Plinth and legs (when requested)

2 DOORS LEFT HAND (short door top, tall door at bottom)

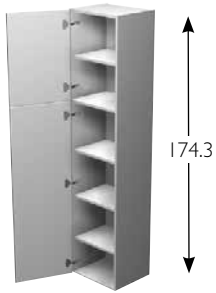

Depth (cm)	Code	Width (cm)	Price Group 0	Price Group 1	Price Group 2	Price Group 3
33	A3330L	30	£695	£722	£772	£991
	A3335L	35	£733	£772	£820	£1079
	A3340L	40	£787	£816	£871	£1111
20	A2030L	30	£695	£722	£772	£991
	A2035L	35	£733	£772	£820	£1079
	A2040L	40	£787	£816	£871	£1111

❗ No worktop

Add suffix **PU** to code for handleless push latch opening

2 DOORS RIGHT HAND (short door top, tall door at bottom)



Depth (cm)	Code	Width (cm)	Price Group 0	Price Group 1	Price Group 2	Price Group 3
33	A3330R	30	£695	£722	£772	£991
	A3335R	35	£733	£772	£820	£1079
	A3340R	40	£787	£816	£871	£1111
20	A2030R	30	£695	£722	£772	£991
	A2035R	35	£733	£772	£820	£1079
	A2040R	40	£787	£816	£871	£1111

❗ No worktop

Add suffix **PU** to code for handleless push latch opening

2 DOORS, 1 DRAWER (RH shown)

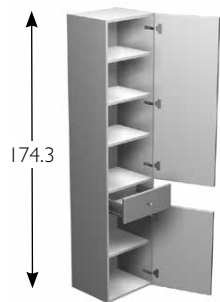

Depth (cm)	Code	Width (cm)	Price Group 0	Price Group 1	Price Group 2	Price Group 3
33	AT3330L	30	£925	£963	£1039	£1258
	AT3335L	35	£958	£1013	£1079	£1319
	AT3340L	40	£1024	£1061	£1133	£1401
33	AT3330R	30	£925	£963	£1039	£1258
	AT3335R	35	£958	£1013	£1079	£1319
	AT3340R	40	£1024	£1061	£1133	£1401

❗ No worktop

❗ No moulding on Provence drawer fascia

COLOURMATCHED SIDE



To visible side of unit
£ 245 for tall unit

STRAIGHT TALL FILLER



EFILL201D
Includes extra plinth
£ 119

CURVED TALL END PANEL

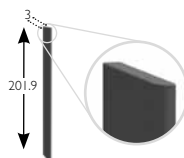

EPANELACUR20/33
£ 285

PROVENCE TALL END PANEL

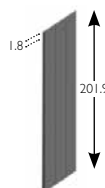

EPANELPROVA20/33
(20 deep shown) £ 285



SMO™ WORKTOPS
see page **24-27**

BATH PANELS
see page **29**

MIRRORS
see page **30-31**

ANCILLARY ITEMS
see page **36-37**

HI-LINE TALL UNITS

ALL PRICES INCLUDE

- Handles
- Plinth and legs (when requested)

187 CM HIGH UNITS / 14.8 CM HIGH PLINTH

HI-LINE 2 DOORS LEFT HAND (short door top, tall door at bottom)

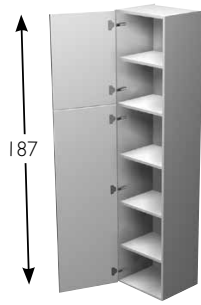

Depth (cm)	Code	Width (cm)	Price Group 0	Price Group 1	Price Group 2	Price Group 3
33	AHL3330L	30	£695	£722	£772	£991
	AHL3335L	35	£733	£772	£820	£1079
	AHL3340L	40	£787	£816	£871	£1111
20	AHL2030L	30	£695	£722	£772	£991
	AHL2035L	35	£733	£772	£820	£1079
	AHL2040L	40	£787	£816	£871	£1111

❗ No worktop

Add suffix **PU** to code for handleless push latch opening

HI-LINE 2 DOORS RIGHT HAND (short door top, tall door at bottom)

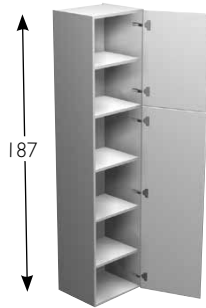

Depth (cm)	Code	Width (cm)	Price Group 0	Price Group 1	Price Group 2	Price Group 3
33	AHL3330R	30	£695	£722	£772	£991
	AHL3335R	35	£733	£772	£820	£1079
	AHL3340R	40	£787	£816	£871	£1111
20	AHL2030R	30	£695	£722	£772	£991
	AHL2035R	35	£733	£772	£820	£1079
	AHL2040R	40	£787	£816	£871	£1111

❗ No worktop

Add suffix **PU** to code for handleless push latch opening

HI-LINE 2 DOORS 1 DRAWER (RH shown)

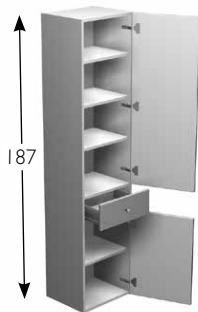

	Depth (cm)	Code	Width (cm)	Price Group 0	Price Group 1	Price Group 2	Price Group 3
LH	33	ATHL3330L	30	£925	£963	£1039	£1258
		ATHL3335L	35	£958	£1013	£1079	£1319
		ATHL3340L	40	£1024	£1061	£1133	£1401
RH	33	ATHL3330R	30	£925	£963	£1039	£1258
		ATHL3335R	35	£958	£1013	£1079	£1319
		ATHL3340R	40	£1024	£1061	£1133	£1401

❗ No worktop

❗ No moulding on Provence drawer fascia

Add suffix **PU** to code for handleless push latch opening

COLOURMATCHED SIDE



To visible side of unit
£ 245 for tall unit

STRAIGHT TALL FILLER



EFILL201D
Includes extra plinth
£ 119

CURVED TALL END PANEL

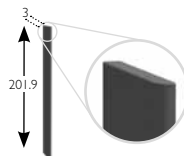

EPANELACUR20/33
£ 285

PROVENCE TALL END PANEL

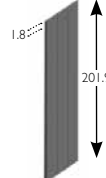

EPANELPROVA20/33
(20 deep shown) £ 285



SMO™ WORKTOPS
see page **24-27**

BATH PANELS
see page **29**

MIRRORS
see page **30-31**

ANCILLARY ITEMS
see page **36-37**

SHORT WALL UNITS

1 DOOR (RH shown)



	Depth (cm)	Code	Width (cm)	Price Group 0	Price Group 1	Price Group 2	Price Group 3
LH	18	H5620L*	20	£437	£465	£487	£498
		H5630L	30	£437	£465	£487	£498
		H5635L	35	£443	£465	£514	£535
		H5640L	40	£459	£498	£531	£546
RH	18	H5620R*	20	£437	£465	£487	£498
		H5630R	30	£437	£465	£487	£498
		H5635R	35	£443	£465	£514	£535
		H5640R	40	£459	£498	£531	£546

* N/A in PURA door style.

Add suffix **PU** to code for handleless push latch opening

2 DOORS



	Depth (cm)	Code	Width (cm)	Price Group 0	Price Group 1	Price Group 2	Price Group 3
18	18	H5660	60	£575	£608	£641	£695
		H5670	70	£575	£619	£656	£700
		H5680	80	£601	£641	£673	£722

Add suffix **PU** to code for handleless push latch opening



SMO™ WORKTOPS
see page **24-27**

BATH PANELS
see page **29**

MIRRORS
see page **30-31**

ANCILLARY ITEMS
see page **36-37**

TALL WALL UNITS

1 DOOR
(RH shown)



LH

RH

Depth (cm)	Code	Width (cm)	Price Group 0	Price Group 1	Price Group 2	Price Group 3
18	H8520L*	20	£459	£487	£525	£564
	H8530L	30	£459	£487	£525	£564
	H8535L	35	£465	£503	£535	£590
	H8540L	40	£476	£525	£546	£619
	H8520R*	20	£459	£487	£525	£564
	H8530R	30	£459	£487	£525	£564
	H8535R	35	£465	£503	£535	£590
	H8540R	40	£476	£525	£546	£619

* N/A in PURA door style.

Add suffix **PU** to code for handleless push latch opening

2 DOORS



Depth (cm)	Code	Width (cm)	Price Group 0	Price Group 1	Price Group 2	Price Group 3
18	H8560	60	£608	£656	£684	£750
	H8570	70	£612	£659	£695	£761
	H8580	80	£641	£684	£733	£772

Add suffix **PU** to code for handleless push latch opening

Individually ordered wastes, handles and ancillary items will incur a £10 P & P charge.

STRAIGHT
WALL FILLER

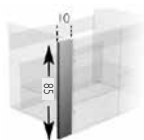

EFILL85D
£ 95

PROVENCE WALL
END PANEL

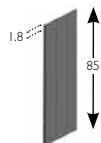

EPANELHPROV18
£ 125

COLOURMATCHED
SIDE



To visible side of unit
£ 125 per side

INTERNAL SHAVER
SOCKET



SHAVERUK
with switch for additional lighting
£ 195

PANORAMIC MIRRORS

TALL MIRROR ON FULL UPSTAND

Includes mirror fixing rails

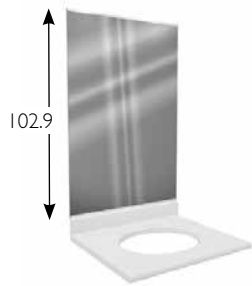

- ❗ FIXEMIDECO clips required when used without light pelmet
- ❗ For special size, take price of superior dimension +15%

Code	Width (cm)	Price
MID50	50	£246
MID60	60	£273
MID70	70	£301
MID80	80	£349
MID90	90	£400
MID100	100	£465
MID110	110	£476
MID120	120	£525
MID130	130	£564
MID140	140	£608
MID150	150	£656
MID160	160	£695

TALL MIRROR ON MINI UPSTAND

Includes mirror fixing rails

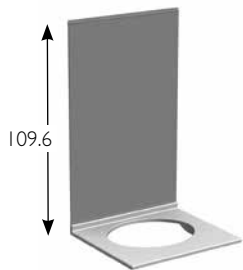

- ❗ FIXEMIDECO clips required when used without light pelmet
- ❗ For special size, take price of superior dimension +15%

Code	Width (cm)	Price
MIV50	50	£246
MIV60	60	£273
MIV70	70	£301
MIV80	80	£349
MIV90	90	£400
MIV100	100	£465
MIV110	110	£476
MIV120	120	£525
MIV130	130	£564
MIV140	140	£608
MIV150	150	£656
MIV160	160	£695

WALL SHELVING PANELS

MODEL A
Mirrored back panel.
Glass shelves. Includes mirror fixing rails

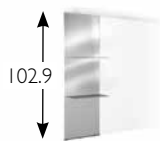

Code	Width (cm)	Price
PANELMA30	30	£306
PANELMA35	35	£306
PANELMA40	40	£306

To be placed by MID mirror. 2 shelves centred on total height. ❗ FIXEMIDECO clips required when used without light pelmet

MODEL C
Mirrored back panel.
Glass shelves. Includes mirror fixing rails

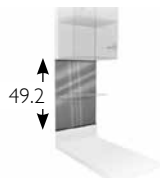

Code	Width (cm)	Price
PANELMC30	30	£306
PANELMC35	35	£306
PANELMC40	40	£306

To be placed between upstand and underneath short wall unit. 1 shelf centred on total height. ❗ FIXEMIDECO clips required when used without light pelmet

MODEL G
Mirrored back panel.
Glass shelf Includes mirror fixing rails

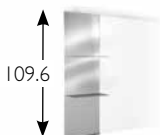

Code	Width (cm)	Price
PANELMG30	30	£306
PANELMG35	35	£306
PANELMG40	40	£306

To be placed by MIV mirror. 2 shelves centred on total height. ❗ FIXEMIDECO clips required when used without light pelmet

LIGHT PELMETS

LIGHTING PELMETS

Includes Chrome LED spotlights
(4000k - IP44 Rated)



❗ Laminate colours have bullnose profile, foil colours have square edged profile.

❗ For special size, take the price of superior dimension and + 15%.

❗ Maximum length for foil colours is 200cm.

Code	Width (cm)	Spotlights	Price
LP1750	50	2	£433
LP1760	60	2	£443
LP1770	70	2	£459
LP1780	80	3	£487
LP1790	90	3	£564
LP1795	95	3	£575
LP17100	100	3	£579
LP17105	105	3	£590
LP17110	110	4	£608
LP17115	115	4	£634
LP17120	120	4	£667
LP17125	125	4	£684
LP17130	130	4	£684
LP17135	135	4	£695
LP17140	140	4	£706
LP17145	145	4	£733
LP17150	150	5	£820
LP17155	155	5	£838
LP17160	160	5	£849
LP17165	165	5	£871
LP17170	170	5	£897
LP17175	175	5	£908
LP17180	180	5	£958
LP17185	185	5	£991
LP17190	190	5	£1039
LP17195	195	5	£1079
LP17200	200	6	£1013
LP17210	210	6	£1182
LP17220	220	6	£1210
LP17230	230	6	£1236
LP17240	240	7	£1302
LP17250	250	7	£1319

Individually ordered wastes, handles and ancillary items will incur a £10 P & P charge.

EXTRA LENGTH MIRROR FIXING RAIL



MRAIL
Per linear metre
£ 27

MIRROR FILLER



❗ Not suitable for use with MIV mirror

MFILL102D
H1029 x W100mm
To fill gap between mirror and wall.
Colour to match front with 1 square edge, 1 rounded edge.
£ 268

SPARE LIGHT PELMET BRACKET



LPBRACK
Spare Pelmet fixing bracket
£ 10

ANTIMIST HEATED MIRROR PAD

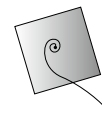

ANTIMIST
H40 x W35cm
to be connected to mains
£ 125

MIRROR CLIPS



FIXEMIDECO
Mirror fixing spring clips
(box of 4)
for fixing mirror without MRAIL
£ 27

**WE DO NOT RECOMMEND
THE USE OF SMO™ BASINS
AND WORKTOPS WITH
WATER TEMPERATURE
OVER 60°C.**

SMO™

Worktops

Shelves

Window Sills

SMO™ is a cast material made from natural calcium carbonate and polyester. It is coloured using organic powder pigments and baked to 80° Celcius to ensure stability. It is coated with a sanitary gel coat during its manufacture and can be cut or drilled using normal woodworking tools and a jigsaw with fine tooth sharp blade.

SMO™ is a hand moulded material that will have slight imperfections in size, flatness, dimples and some shade variations. This is all part of the tolerances of this modern moulded material and cannot be exchanged or refunded under the guarantee policy.

All SMO™ basins will be supplied with one tap hole and in Gloss White unless otherwise specified.

SMO™ WORKTOP WITH 1 BASIN

Extra price to upgrade worktop from laminated without upstand to SMO™.

For SMO™ worktop without units, add £ 26 per 10cm on top of upgrade price.

All basin designs are at the same price.

For intermediary length, take price of the superior dimension

For bowl design and worktop shape take code from the following 2 pages.

❶ Always check maximum length/distances and bowl position according to mould limitations shown on each drawing.

❷ Double bowl only possible with full depth 50 or 60 deep inset worktops, Minimum 70cm between centre of basins.

EXTRA BASIN + £454

❸ All SMO basins are supplied with one tap hole unless specified without.





Length (cm)	Upgrade price without upstand £	Upgrade price with upstand £
60	£733	£816
70	£798	£886
80	£871	£958
90	£925	£1039
100	£1013	£1133
110	£1090	£1192
120	£1149	£1287
130	£1221	£1357
140	£1287	£1444
150	£1357	£1528
160	£1444	£1593
170	£1510	£1670
180	£1576	£1757
190	£1637	£1828
200	£1707	£1900
210	£1790	£1976
220	£1860	£2068
230	£1915	£2141
240	£1992	£2211
250	£2068	£2283

SMO™ WORKTOP WITHOUT MOULDED BASIN

Also used for shelves and window sills etc.

	Code	Depth (cm)	Price per 10cm
With upstand (Specify mini or standard upstand)	ZTABR23	23.5	£76
	ZTABR36	36.5	£93
	ZTABR50	50	£93
	ZTABR60	60	£93
Without upstand	ZTAB23	23.5	£60
	ZTAB36	36.5	£71
	ZTAB50	50	£87
	ZTAB60	60	£87

Individually ordered wastes, handles and ancillary items will incur a £10 P & P charge.

<p>SMO™ REPAIR KIT</p>  <p>KITSMOC includes polishing kit £ 99</p>	<p>SMO™ POLISHING KIT</p>  <p>KITSMOP £ 79</p>	<p>SPARE OVER FLOW KIT</p>  <p>KITOVER / KITTROPPEINNO External overflow complete with chrome / matt black bezel £ 44</p>	<p>SMO™ JOINT</p>  <p>JOINT The 2 worktops will be square edged and butt one against the other £ 130</p>	<p>CUT BACK IN DEPTH OF SMO™ WORKTOP</p>  <p>ZDECPROF £ 195</p>
--	--	---	--	---

WE DO NOT RECOMMEND THE USE OF SMO™ BASINS AND WORKTOPS WITH WATER TEMPERATURE OVER 60°C.

All SMO™ bowl designs are priced the same. Choose the style that you require, note the code and calculate the price according to the length on p.25

SEMI-COUNTERTOP BASIN - To be used with standard 33cm deep basin unit BU33 or BUT33.

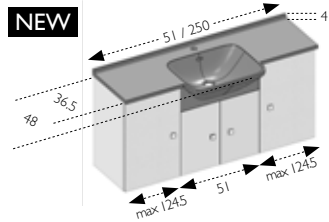

Bowl W 45.7 x D 35.9 x H 13 - Minimum 50cm width basin unit.

Without upstand
With upstand

Worktop depth (cm)	Max. bowl projection (cm)	Code
36.5	48	ZBASR36S + LENGTH
		ZBASR36R + LENGTH

SEMI-COUNTERTOP REDUCED DEPTH BASIN - To be used with standard 20cm deep basin unit BU20.

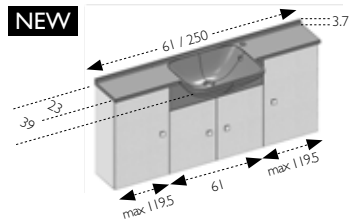

Bowl W 45.7 x D 35.6 x H 13 - Minimum 60cm width basin unit. Tap hole only possible on right.

Only available with mini upstand

Worktop depth (cm)	Max. bowl projection (cm)	Code
23	39.1	ZBASR23R+LENGTH

ROUNDED FRONT INSET OVAL BASIN - To be used with rounded basin unit BA70.

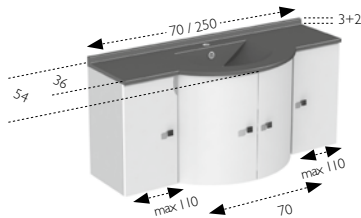

Bowl W 44.5 x D 34.5 x H 12

Only available with mini upstand

Worktop depth (cm)	Max. bowl projection (cm)	Code
36	54	ZNBA70R+LENGTH

55 ROUNDED FRONT REDUCED DEPTH INSET BASIN

- To be used with 55cm reduced depth rounded basin unit BA2055.

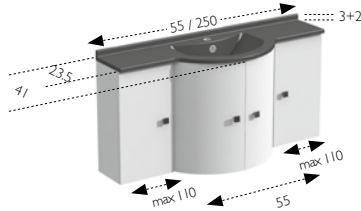

Bowl W 45 x D 24.5 x H 12

Only available with mini upstand

Worktop depth (cm)	Max. bowl projection (cm)	Code
23.5	41	ZROUND5523R + LENGTH

70 ROUNDED FRONT REDUCED DEPTH INSET BASIN

- To be used with 70cm reduced depth rounded basin unit BA2070.

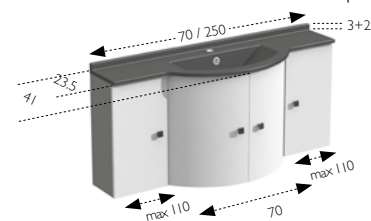

Bowl W 54.5 x D 25 x H 13

Only available with mini upstand

Worktop depth (cm)	Max. bowl projection (cm)	Code
23.5	41	ZROUND23R+LENGTH

INLINE BASIN - Only suitable for a minimum 60cm width basin unit. 10L Basin Capacity

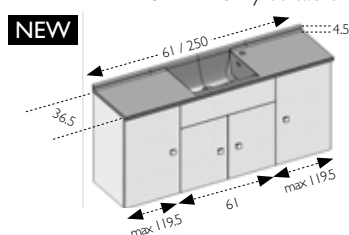

Bowl W 40.5 x D 31.9 x H 13 - Minimum 60cm width basin unit. Supplied with one RH tap hole as standard, can be supplied no tap hole on request.

Only available with mini upstand

Worktop depth (cm)	Max. bowl projection (cm)	Code
36.5	36.5	ZINLINE36R+LENGTH

WE DO NOT RECOMMEND THE USE OF SMO™ BASINS AND WORKTOPS WITH WATER TEMPERATURE OVER 60°C.

All SMO™ bowl designs are priced the same. Choose the style that you require, note the code and calculate the price according to the length on p.25

90 OFFSET BASIN (RH shown) - To be used with 90cm wide offset basin unit ISE090.

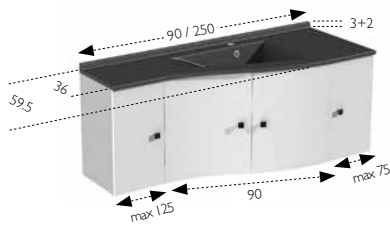

Bowl W 65 x D 38 x H 12

Only available with mini upstand

LH
RH

Worktop depth (cm)	Max. bowl projection (cm)
59.5/36	60
36/59.5	60

Code
ZNISE090GR+LENGTH
ZNISE090DR+LENGTH

90 OFFSET REDUCED DEPTH BASIN (RH shown) - To be used with 90cm wide reduced depth offset basin unit ISE02090.

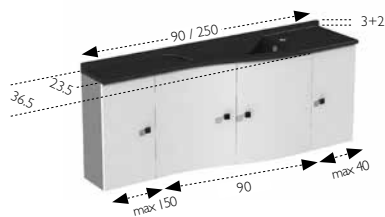

Bowl W 66 x D 27 x H 10

Only available with mini upstand

LH
RH

Worktop depth (cm)	Max. bowl projection (cm)
36.5/23.5	36.5
23.5/36.5	36.5

Code
ZISE02390GR + LENGTH
ZISE02390DR + LENGTH

60 OFFSET BASIN (RH shown) - To be used with 60cm offset basin unit DBA60.

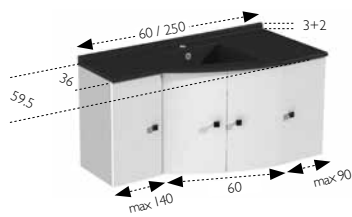

Bowl W 43.5 x D 36 x H 12

Only available with mini upstand

LH
RH

Worktop depth (cm)	Max. bowl projection (cm)
59.5/36	59.5
36/59.5	59.5

Code
ZNDBA60GR + LENGTH
ZNDBA60DR + LENGTH

60 OFFSET REDUCED DEPTH BASIN (RH shown) - To be used with 60cm wide reduced depth offset basin unit DBA2060.

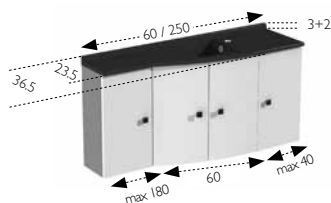

Bowl W 43 x D 28.5 x H 10

Only available with mini upstand

LH
RH

Worktop depth (cm)	Max. bowl projection (cm)
36.5/23.5	36.5
23.5/36.5	36.5

Code
ZDBA2360GR + LENGTH
ZDBA2360DR + LENGTH

INSET 50CM DEPTH BASIN - To be used with 50cm deep basin units BV5647 or BVC5647. Choose Dolce (40 or 55 wide) or Square Bowl



Without upstand
With mini upstand

Worktop depth (cm)	Max. projection (cm)
50	50

Code
ZSV50 + LENGTH
ZSVR50 + LENGTH

ⓘ Dolce 55cm bowl requires minimum 70cm basin unit.

INSET 60CM DEPTH BASIN - To be used with 60cm deep basin unit BFD56 - Choose Oval, Dolce (40 or 55 wide) or Square Bowl. BVC5656 - Dolce (40 or 55 wide) or Square Bowl only.



Without upstand
With large upstand

Worktop depth (cm)	Max. projection (cm)
60	60

Code
ZSV + LENGTH
ZSVR + LENGTH

ⓘ Dolce 55cm bowl requires minimum 70cm basin unit.

SOLID SURFACE WORKTOPS

staron®

Solid Surfaces

12MM STARON® WORKTOPS

Staron countertops are a popular choice across the globe.

They are used in hospitals, doctors / dentist surgeries, restaurants and food preparation areas.

Staron worksurfaces are 100% non-porous which makes them highly suitable for bathrooms, where hygiene is of the utmost importance. As it is non-porous, it means that bacteria and moulds are unable to grow on it, or to penetrate the surface.

This property means that it is also highly resistant to stains. Spills which would cause staining on many countertops – marble, granite and quartz, for instance., although it goes without saying that any spills should be wiped off as soon as they are seen. All that is needed with Staron is a wipe with a damp cloth.

Also used for shelves and window sills etc.



Code	Depth (cm)	Price per 10cm
STARTAB23	23.5	£36
STARTAB36	35.5	£45
STARTAB50	50	£48
STARTAB60	59	£48

❗ For curved front worktops for ISEO and BA units use the deepest worktop and add the curved cut below

❗ Supplied with back support bracket for basin units



SOLID SURFACE
WORKTOP DEPTH
CUT

STARDECPROF
£ 195



SOLID SURFACE
EPANEL CURVE
CUT

STARDECCUR
£ 195



SOLID SURFACE
ANGLED DEPTH
CUT

STARDECPS
£ 195



SOLID SURFACE
ROUNDED DEPTH
CUT

STARDECRC
£ 195



SOLID SURFACE
ROUNDED END
CUT

STARDECBAT
£ 195

BATH PANELS

STANDARD BATH PANELS

with adjustable plinth - 58cm maximum height



Code	Width (cm)	Price
KOMBATH170	170	£345
KOMBATH180	180	£345
KOMBATH70	70	£185
KOMBATH75	75	£195
KOMBATH80	80	£199

HIGH BATH PANEL

with adjustable plinth - 68cm maximum height



Code	Width (cm)	Price
HIBATH170	170	£345
HIBATH180	180	£345
HIBATH70	70	£185
HIBATH75	75	£195
HIBATH80	80	£199

PROVENCE BATH PANELS

with adjustable plinth - 58cm maximum height

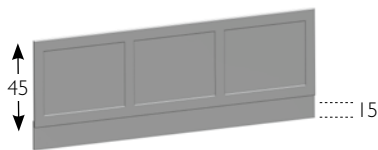

Code	Width (cm)	Price
PROVBATH170	170	£395
PROVBATH180	180	£395
PROVBATH70	70	£185
PROVBATH75	75	£190
PROVBATH80	80	£195

PROVENCE OFFSET FRONT PANELS

with adjustable plinth - 58cm maximum height

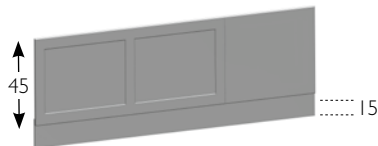

Code	Width (cm)	Price
PROVOFFBATH170	170	£395
PROVOFFBATH180	180	£395

i Bath filler unit required

STANDARD BATH FILLER UNIT

5 cm wide



Code	Height (cm)	Depth (cm)	Price
BATHFILL5656	56.4	56.4	£159
BATHFILL5633	56.4	33	£159
BATHFILL5620	56.4	20	£159
BATHFILL8833	88.6	33	£185
BATHFILL8820	88.6	20	£185

TALL BATH FILLER UNIT

5 cm wide



Code	Height (cm)	Depth (cm)	Price
BATHFILL20120	210	20	£224
BATHFILL20133	210	33	£224
BATHFILL20156	210	56	£224

LED MIRRORS

LED-LIT MIRRORS

LED strip lights (6000K) on each side fitted with SELV switch and antimist. May be fitted vertical or horizontal.

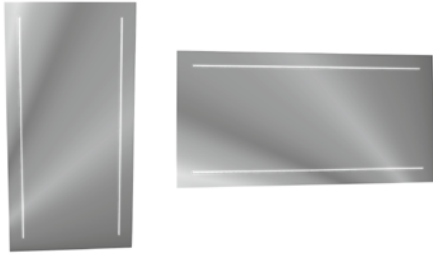

Code	Width (cm)	Height (cm)	Price
MILDH45UK	45	45	£1024
MILDH70UK	70	45	£1171
MILDH90UK	90	45	£1182
MILDH105UK	105	45	£1221
MILDH120UK	120	45	£1247
MILDH140UK	140	45	£1287

ROUND MIRRORS

Peripheral LED lighting (5700K) with touch switch and antimist



	Code	Width (cm)	Height (cm)	Price
Plain	MIROND75	75	75	£395
Etched Border	MIRON75DEP	75	75	£395

ESQUIRE LED LIT MIRRORS

Peripheral LED lighting (4200K)
No switch, to be connected to bathroom lighting circuit.
Can be fitted vertically or horizontally.



Code	Width (cm)	Height (cm)	Price
SQUARE60	60	55	£375
SQUARE90	90	55	£445
SQUARE120	120	55	£495

OVAL LED MIRROR

Peripheral LED lighting (4000K)
No switch, to be connected to bathroom lighting circuit.
Can be fitted vertically or horizontally.



Code	Width (cm)	Height (cm)	Price
MIRADIUS90	90	70	£445

MIRRORS

MOOD MIRRORS

Can be fitted vertically or horizontally.

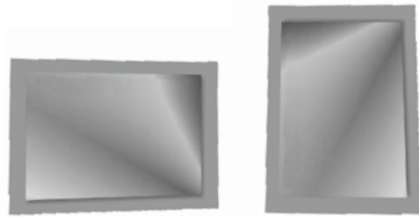

Code	Width (cm)	Height (cm)	Price
MITB40	40	80	£285
MITB55	55	80	£295

MIRROR WITH MATT BLACK METAL FRAME

Delivered with removable telescopic tube
Diameter 16mm Length max 55cm, min 35cm



* Rectangular with shelf
W 31.5 cm Prof. 10 cm.

	Code	Width (cm)	Height (cm)	Price
*Rectangular	MIFORMH	50	100	£595
Round	MIFORMR	70	70	£495

LIGHTS

Individually ordered wastes, handles and ancillary items will incur a £10 P & P charge.

SANCTUARY LIGHT



ECSAN
Chrome LED (6000K)
H4.1 x W45cm
£ 179

⚠ Not suitable for installation
with Mood Mirror

PHANTOM LIGHT



ECIPH
Chrome LED (6000K)
H7 x W20cm
£ 159

OVAL LED LIGHT



ECOVLD
Chrome LED (6000K)
H10 x W20cm
£ 79

CLOUD LIGHT CHROME 30CM



ECCLD
Chrome LED (6000K)
H3.9 x W30cm
£ 149

CLOUD LIGHT MATT BLACK 30CM



ECCLDNO
Matt black LED (6000K)
H3.9 x W30cm
£ 149

CLOUD LIGHT CHROME 50CM



ECCLD50
Chrome LED (6000K)
H5 x W50cm
£ 179

CLOUD LIGHT MATT BLACK 50CM



ECCLD50NO
Matt black LED (6000K)
H5 x W50cm
£ 179

⚠ These lights are unswitched to be wired and switched via bathroom lighting circuit

BASIN UNIT TOP FASCIA

FIXED FASCIAS FOR BASIN UNIT - WITHOUT PRE-CUT FOR BASIN

Code	Width (cm)	Height (cm)	Price Group 0	Price Group 1	Price Group 2	Price Group 3
FF50	49.7	15.9	£108	£115	£119	£130
FF60	59.7	15.9	£119	£126	£130	£141
FF70	69.7	15.9	£130	£141	£141	£174
FF80	79.7	15.9	£148	£152	£152	£185

! No moulding on Provence door style

FIXED FASCIAS FOR BASIN UNIT - PRE-CUT FOR STANDARD RESIN WORKTOP

Code	Width (cm)	Height (cm)	Price Group 0	Price Group 1	Price Group 2	Price Group 3
FF50SMOZBASR	49.7	15.9	£108	£115	£119	£130
FF60SMOZBASR	59.7	15.9	£119	£126	£130	£141
FF70SMOZBASR	69.7	15.9	£130	£141	£141	£174
FF80SMOZBASR	79.7	15.9	£148	£152	£152	£185

! No moulding on Provence door style

WC TOP FASCIA

FOR ALL WC UNITS - UNDRILLED

Code	Width (cm)	Height (cm)	Price Group 0	Price Group 1	Price Group 2	Price Group 3
FF40	39.7	15.9	£108	£115	£119	£130
FF50	49.7	15.9	£108	£115	£119	£130
FF60	59.7	15.9	£119	£126	£130	£141
FF70	69.7	15.9	£130	£141	£141	£174
FF80	79.7	15.9	£148	£152	£152	£185

! No moulding on Provence door style

WC BOTTOM FASCIA

FOR STANDARD WC UNIT

Code	Width (cm)	Height (cm)	Price Group 0	Price Group 1	Price Group 2	Price Group 3
FACADEEBWC4040	39.7	40	£130	£141	£152	£181
FACADEEBWC4050	49.7	40	£148	£152	£170	£203
FACADEEBWC4060	59.7	40	£246	£257	£262	£273
FACADEEBWC4070	69.7	40	£327	£338	£345	£349
FACADEEBWC4080	79.7	40	£327	£349	£367	£378

FOR WALL HUNG AND FLOOR MOUNTED WC UNITS

Code	Width (cm)	Height (cm)	Price Group 0	Price Group 1	Price Group 2	Price Group 3
FACADEEBWCWH6640	39.7	66.6	£207	£224	£251	£279
FACADEEBWCWH6650	49.7	66.6	£246	£257	£279	£284
FACADEEBWCWH6660	59.7	66.6	£273	£284	£290	£306
FACADEEBWCWH6670	69.7	66.6	£349	£371	£378	£393
FACADEEBWCWH6680	79.7	66.6	£367	£378	£378	£411

FOR HI-LINE WC UNITS

Code	Width (cm)	Height (cm)	Price Group 0	Price Group 1	Price Group 2	Price Group 3
FACADE392WC	39.7	52.8	£170	£181	£203	£229
FACADE393WC	49.7	52.8	£196	£207	£224	£240
FACADE391WC	59.7	52.8	£262	£273	£279	£290
FACADE394WC	69.7	52.8	£338	£356	£360	£371
FACADE395WC	79.7	52.8	£349	£367	£371	£393

Individually ordered wastes, handles and ancillary items will incur a £10 P & P charge.

SLIDE FASCIA CLIPS



CLIPSF B
For fixing fascias
£ 10

PUSH FASCIA CLIPS



CLIPSF H
For fixing fascias
£ 10



SMO™ WORKTOPS
see page **24-27**

BATH PANELS
see page **29**

MIRRORS
see page **30-31**

ANCILLARY ITEMS
see page **36-37**

NB

- Fascias are always 0.2-0.3cm smaller than the unit carcass to allow clearance for removal and/or door and drawer opening. (e.g. 59.7 fascia fits 60cm unit)

- For special sizes, take the price of the superior dimension + 15% (maxi 118x59.7cm)

SPECIFICATIONS

All codes are for unhinged fascias, undrilled for handles

For hinged doors, add the following letter at the end of the code:

L for left-hand hinged

R for right hand hinged

T for drawer

2 hinges fitted to fascias up to 88.3cm

3 hinges fitted to fascias over 88.4cm

Please note the prices exclude hinge back plates: see below.

For special sizes, take the price of the superior dimension + 15% (maxi 118 x 59.7cm)

Individually ordered wastes, handles and ancillary items will incur a £10 P & P charge.

HINGE BACK PLATE



① 2 required for fascias up to 88.3cm
3 required for fascias over 88.4cm

BPLATE £9

Code	Width (cm)	Height (cm)	Price Group 0	Price Group 1	Price Group 2	Price Group 3
FACADE01	14.7	13	£108	£115	£126	£130
FACADE02	14.7	13.2	£108	£115	£126	£130
FACADE03	14.7	15.9	£115	£115	£126	£141
FACADE04	29.7	15.9	£115	£119	£130	£152
FACADE05	34.7	15.9	£119	£126	£141	£170
FACADE06	39.7	15.9	£126	£130	£152	£170
FACADE07	44.7	15.9	£108	£108	£126	£130
FACADE08	49.7	15.9	£108	£115	£119	£130
FACADE09	59.7	15.9	£119	£126	£141	£141
FACADE10	69.7	15.9	£130	£141	£141	£174
FACADE11	79.7	15.9	£148	£152	£152	£185
FACADE13	99.7	15.9	£174	£181	£185	£192
FACADE14	29.7	20.6	£130	£148	£185	£203
FACADE15	34.7	20.6	£141	£152	£192	£207
FACADE16	39.7	20.6	£192	£203	£214	£257
FACADE17	44.7	20.6	£203	£214	£224	£273
FACADE18	49.7	20.6	£214	£218	£235	£284
FACADE19	29.7	23.8	£159	£170	£207	£218
FACADE190	14.7	23.8	£115	£119	£130	£152
FACADE20	34.7	23.8	£181	£185	£192	£235
FACADE21	39.7	23.8	£192	£203	£214	£257
FACADE22	44.7	23.8	£192	£207	£214	£257
FACADE23	49.7	23.8	£214	£218	£235	£284
FACADE251	29.7	28	£192	£203	£214	£251
FACADE252	34.7	28	£207	£207	£218	£251
FACADE253	39.7	28	£207	£218	£235	£262
FACADE255	59.7	28	£207	£218	£235	£262
FACADE257	69.7	28	£273	£284	£301	£356
FACADE259	89.7	28	£284	£301	£312	£371
FACADE29	29.7	32	£207	£207	£218	£257
FACADE30	34.7	32	£214	£214	£224	£257
FACADE31	39.7	32	£214	£218	£240	£273
FACADE32	44.7	32	£279	£284	£306	£367
FACADE33	49.7	32	£290	£306	£327	£378
FACADE227	24.7	40	£185	£203	£207	£246
FACADE34	29.7	40	£203	£203	£214	£251
FACADE35	34.7	40	£207	£207	£218	£251
FACADE36	39.7	40	£207	£214	£235	£262
FACADE37	44.7	40	£214	£214	£235	£273
FACADE38	49.7	40	£214	£214	£235	£273
FACADE381	69.7	40	£257	£262	£279	£327
FACADE382	89.7	40	£284	£290	£316	£345
FACADE383	119.7	40	£312	£327	£327	£378
FACADE384	59.7	40	£312	£327	£327	£378
FACADE44	29.7	52.8	£192	£207	£224	£251
FACADE45	34.7	52.8	£207	£224	£246	£262
FACADE46	39.7	52.8	£218	£240	£257	£279
FACADE47	44.7	52.8	£224	£246	£257	£290
FACADE48	49.7	52.8	£235	£251	£273	£301
FACADE91	19.7	56.1	£203	£203	£207	£214
FACADE49	29.7	56.1	£207	£207	£214	£251
FACADE50	34.7	56.1	£207	£207	£224	£257
FACADE51	39.7	56.1	£214	£214	£235	£273
FACADE52	44.7	56.1	£218	£224	£235	£279

FASCIAS

Code	Width (cm)	Height (cm)	Price Group 0	Price Group 1	Price Group 2	Price Group 3
FACADE53	49.7	56.1	£224	£235	£240	£279
FACADE535	69.7	66.6	£349	£356	£371	£411
FACADE536	79.7	66.6	£367	£378	£382	£422
FACADE537	89.7	66.6	£378	£382	£393	£437
FACADE54	29.7	68.9	£235	£251	£273	£301
FACADE55	34.7	68.9	£251	£262	£290	£312
FACADE56	39.7	68.9	£262	£279	£301	£327
FACADE57	44.7	68.9	£273	£290	£312	£327
FACADE58	49.7	68.9	£279	£301	£316	£327
FACADE59	24.7	81	£257	£284	£301	£327
FACADE60	29.7	81	£273	£301	£306	£327
FACADE61	34.7	81	£290	£316	£327	£349
FACADE62	39.7	81	£306	£338	£345	£367
FACADE63	44.7	81	£306	£338	£349	£378
FACADE64	49.7	81	£257	£279	£290	£345
FACADE205	19.7	84.7	£290	£290	£312	£367
FACADE65	24.7	84.7	£273	£284	£306	£356
FACADE66	29.7	84.7	£284	£301	£312	£371
FACADE67	34.7	84.7	£290	£306	£327	£378
FACADE68	39.7	84.7	£301	£312	£327	£393
FACADE69	44.7	84.7	£306	£327	£338	£400
FACADE70	49.7	84.7	£306	£327	£338	£404
FACADE147	59.7	84.7	£316	£338	£349	£411
FACADE701	29.7	87	£290	£306	£327	£378
FACADE702	34.7	87	£301	£312	£327	£437
FACADE703	39.7	87	£306	£327	£338	£400
FACADE704	49.7	87	£312	£327	£345	£411
FACADE705	59.7	87	£327	£338	£349	£415
FACADE71	29.7	88.3	£301	£312	£327	£327
FACADE72	34.7	88.3	£301	£316	£327	£338
FACADE73	39.7	88.3	£306	£327	£327	£345
FACADE148	49.7	88.3	£312	£327	£345	£349
FACADE149	59.7	88.3	£327	£327	£349	£367
FACADE731	29.7	93.4	£301	£316	£327	£338
FACADE732	34.7	93.4	£306	£327	£338	£345
FACADE733	39.7	93.4	£312	£327	£338	£349
FACADE734	49.7	93.4	£316	£338	£345	£356
FACADE735	59.7	93.4	£327	£345	£349	£367
FACADE74	29.7	98.5	£306	£327	£327	£345
FACADE75	34.7	98.5	£306	£327	£338	£345
FACADE76	39.7	98.5	£312	£327	£345	£349
FACADE77	29.7	101.8	£306	£327	£327	£345
FACADE78	34.7	101.8	£306	£327	£338	£345
FACADE79	39.7	101.8	£312	£327	£345	£349
FACADE150	49.7	101.8	£327	£338	£349	£367
FACADE151	59.7	101.8	£327	£345	£356	£448
FACADE80	29.7	114.6	£306	£327	£327	£349
FACADE81	34.7	114.6	£312	£327	£338	£367
FACADE82	39.7	114.6	£312	£327	£345	£371
FACADE83	29.7	118	£306	£327	£327	£349
FACADE84	34.7	118	£312	£327	£338	£367
FACADE85	39.7	118	£312	£327	£345	£371
FACADE86	44.7	118	£327	£338	£349	£378
FACADE87	49.7	118	£327	£345	£356	£378
FACADE152	59.7	118	£338	£349	£367	£470

NB

- Fascias are always 0.2-0.3cm smaller than the unit carcass to allow clearance for removal and/or door and drawer opening. (e.g. 59.7 fascia fits 60cm unit)

- For special sizes, take the price of the superior dimension + 15% (maxi 118x59.7cm)

SPECIFICATIONS

All codes are for unhinged fascias, undrilled for handles

For hinged doors, add the following letter at the end of the code:

L for left-hand hinged

R for right hand hinged

T for drawer

2 hinges fitted to fascias up to 88.3cm
3 hinges fitted to fascias over 88.4cm

Please note the prices exclude hinge back plates: see below.

For special sizes, take the price of the superior dimension + 15% (maxi 118 x 59.7cm)

Individually ordered wastes, handles and ancillary items will incur a £10 P & P charge.

HINGE BACK PLATE



① 2 required for fascias up to 88.3cm
3 required for fascias over 88.4cm

BPLATE £9

ANCILLARY ITEMS

LAMINATE WORKTOP IS INCLUDED WITH ALL FITTED BASE UNITS. USE THE PRICING BELOW FOR EXTRA LENGTHS AND SPARES ONLY.

EXTRA BULL NOSE 30mm WORKTOP without upstand



Code	Depth (cm)		Price
PLPD2303	23.5	per 10cm	£28
PLPD3603	36.5	per 10cm	£28
PLPD03	60	per 10cm	£28

EXTRA SQUARE EDGED 30mm WORKTOP without upstand



Code	Depth (cm)		Price
PLSD2303	23.5	per 10cm	£28
PLSD3603	36.5	per 10cm	£28
PLSD03	60	per 10cm	£28

EXTRA BULL NOSE 30mm WORKTOP with 9cm upstand



Code	Depth (cm)		Price
PLPDDO1223	23.5	per 10cm	£56
PLPDDO1236	36.5	per 10cm	£56
PLPDDO12	60	per 10cm	£56

EXTRA SQUARE EDGED 30mm WORKTOP with 9cm upstand



Code	Depth (cm)		Price
PLSDDO1223	23.5	per 10cm	£56
PLSDDO1236	36.5	per 10cm	£56
PLSDDO12	60	per 10cm	£56

EXTRA 1/2 ROUND EDGED 18mm SHELF

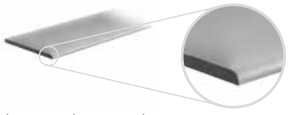

Code	Depth (cm)		Price
TOPS	10-60cm (specify)	per 10cm	£28

📌 Laminate colours only

staron® SOLID SURFACE 12mm WORKTOPS & SHELVES



Code	Depth (cm)		Price per 10cm
STARTAB23	23.5	per 10cm	£36
STARTAB36	35.5	per 10cm	£45
STARTAB50	50	per 10cm	£48
STARTAB60	59	per 10cm	£48

📌 Also used for Shelves and Window Sills etc.

ANCILLARY ITEMS

LAMINATE SHEET

1-2mm thick sheet material



Code

STRAT

per sq. meter
(£85 min per piece)

Price

£203

MELAMINE BOARD

16mm thick fully PVC edged sheet material both sides colour



minimum 15.5cm x 15.5 cm

Code

PAMEL16

per sq. meter
(£85 min per piece)

Price

£134

LAMINATED or FOIL WRAPPED BOARD

16mm thick fully edged sheet material one side colour, one side white



minimum 15.5 x 15.5cm

Code

PASTR1

per sq. meter
(£122.64 min per piece)

Price

£595

EDGING

PVC edging tape for hot glue or contact adhesive bonding

ⓘ Not possible in all colours - Check availability

Code

EDGING24

Width
(mm)

24

per meter

Price

£34

EDGING34

34

per meter

£34

EXTRA PLINTH

with bonded rubber bottom seal



Code

PLINTH27

Height
(cm)

27

per 10cm

Price

£16

PLINTH15

15

per 10cm

£16

CORNER SITUATIONS

STRAIGHT CORNER UNIT With 330mm return.

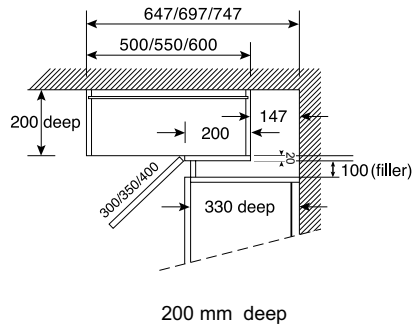
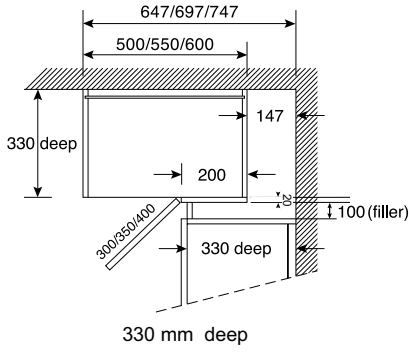

❗ For L Shaped Jointed Worktops, basin side is always the longer worktop into the corner.

STRAIGHT CORNER UNIT With 200mm return.

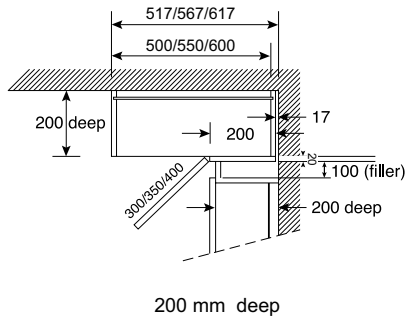
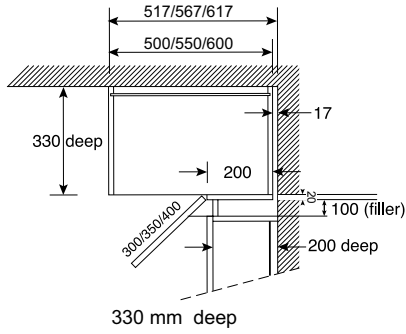

CORNER FILLER

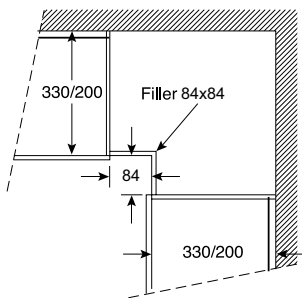

OFFSET BATH FRONT PANEL

OVERHEAD VIEW

PERSPECTIVE

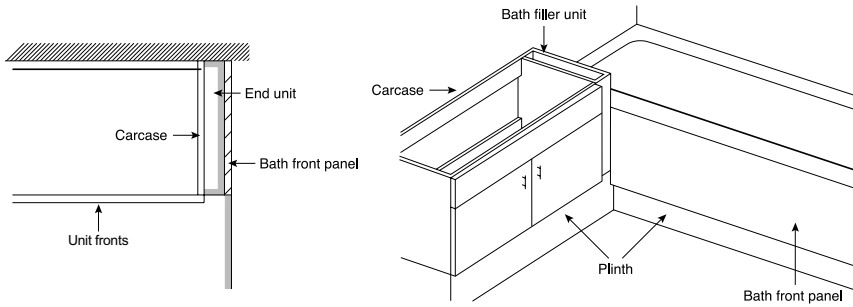

EXAMPLES OF FITTED FURNITURE DIMENSIONS

STANDARD

HI-LINE

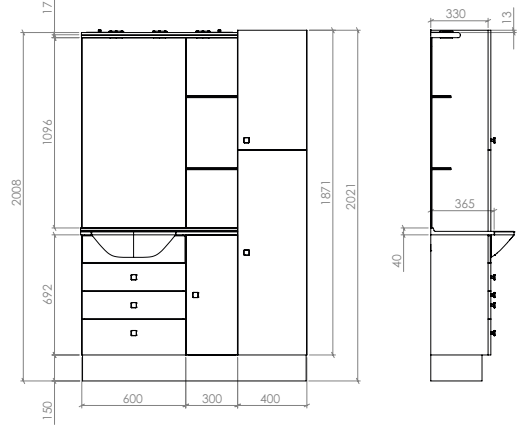
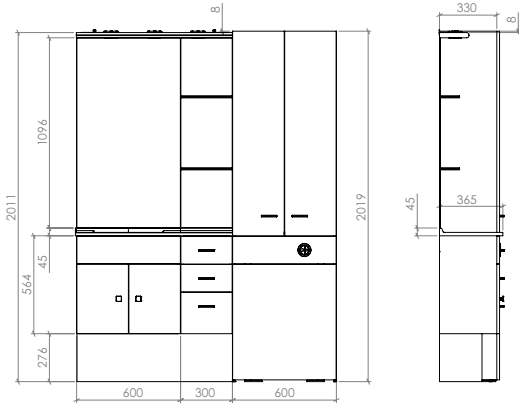

FIRST FIX PLUMBING AND FIXING DIMENSIONS

FITTED RANGE (in mm)

FIXING BRACKET DETAIL (in mm)

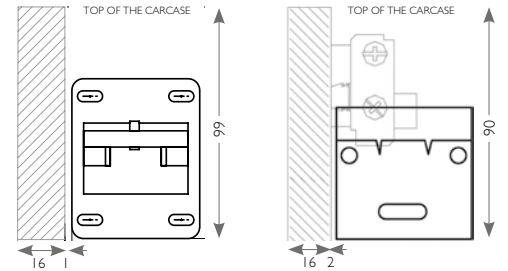
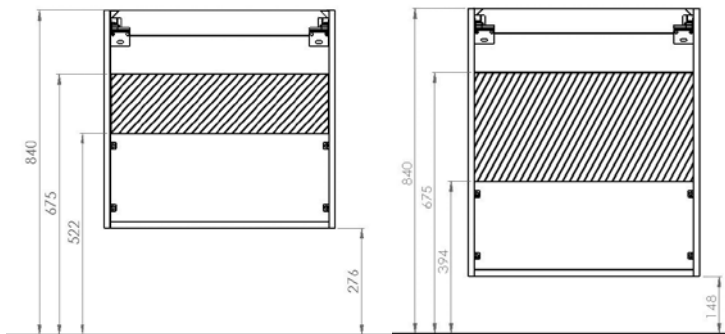

HANDLES & FINISHES

MELAMINE DOOR STYLE



NATIVE
Price Group 0
SQUARE EDGED

LAMINATE DOOR STYLE



LAGOON
Price Group 1
SQUARE EDGED

FOIL DOOR STYLE



KARLA
Price Group 1
SQUARE EDGED



PROVENCE
Price Group 2
COUNTRY SHAKER
STYLE



PURA
Price Group 3
INTEGRATED
CHROME HANDLE

FITTED HANDLES

Each Fitted unit includes Fitted handles. Additional Fitted handles are £ 27 each. The position shown is indicative, but may be different according to the door style or units chosen. Check with the sales office for exact orientation of handles on each unit or order undrilled and fix to clients specification during installation.



P039
WAVE
CHROME



P067
TOULON
NICKEL



P068
RETRO
CHROME



P070
CRYSTAL
CHROME



P037
LUNA CHROME
(HORIZONTAL)



P048
SAIL CHROME
(HORIZONTAL)



P066
VALENCE
CHROME



P027
LONG CRYSTAL BAR
CHROME
(HORIZONTAL)



P035
LOOP CHROME
(HORIZONTAL)



P053
BENT BAR CHROME
(HORIZONTAL)



P055
RIDGE
(HORIZONTAL)



P195
SLOPE
MATT BLACK
(HORIZONTAL)



P197
HORIZON SMALL
MATT WHITE
(HORIZONTAL)



P198
HORIZON SMALL
MATT BLACK
(HORIZONTAL)



P271
SUMIKO CHROME
(HORIZONTAL)



P273
SUMIKO MATT BLACK
(HORIZONTAL)



P275
SUMIKO MATT GOLD
(HORIZONTAL)

Ambiance Bain furniture is manufactured from several different board and foil materials, which are sourced from varying eco friendly European suppliers. Whilst every effort is made to find materials with matching colour and grain patterns it is inevitable that there will be some shade and pattern differences between different materials advertised as the same colour. Wood grain pattern orientations may differ on niches, tall units, fillers, bath panels and plinths due to the dimensional limitations of the raw materials used. All doors, drawers and fascias are made independently. No grain patterns or designs continue from one fascia to another, in any direction, on any Ambiance Bain units. Curved laminate doors, fascias and some worktops will have a visible hand finished "joint line" where the 2 opposing sheets of laminate meet at the top and bottom edge. This is part of the normal manufacturing process. Every Ambiance Bain retailer has samples of all material finishes available for perusal and approval. Please ensure that you and your clients are happy with any and all colour, grain and shade matches prior to ordering any furniture.

COLOURS & FINISHES

MELAMINE DOOR & CARCASE COLOURS

All carcasses are supplied in M411 Matt White if not specified. Alternatively choose from the carcass colours listed below;



FOIL DOOR COLOURS



LAMINATE DOOR AND WORKTOP COLOURS



SMO™ WORKTOPS, BASINS & SHOWERS COLOURS



Modular SMO™ basins are supplied in Gloss white as standard. 18 other standard finishes above are available at the same price as well as up to 200 RAL colours with a supplementary charge. All SMO™ basins are supplied with one tap hole per bowl. Undrilled no tap hole options are available upon request.

staron® SOLID SURFACE WORKTOP COLOURS





AMBIANCE BAIN
15 Cranford Court - Hardwick Grange
Woolston - Warrington - WA1 4RX
TEL : 01925 852675
sales@ambiancebain.com

www.ambiancebain.co.uk